

HAWK
PERFORMANCE

RACE PROVEN. STREET LEGAL.[™]
BRAKE PAD TECHNOLOGY























Control. Command. Conquer.

Control. Command. Conquer. Control. Command. Conquer.

PERFORMANCE **2009** CATALOG

>>> HAWK PADS - STREET LEGAL >>> BRAKE PAD TECHNOLOGY >>>

Introduction	2	
Table of Contents	3	
Performance Street Brake Pads	4	
HPS	6	
Performance Ceramic	7	
LTS	8	
Commercial Truck/Autocross	9	
Street FAQs & Warranty	10	
Street Performance Marketing	12	
Motorsports Introduction	14	
Motorsports Series Partnerships	16	
Motorsports Testimonials	17	
Motorsports Compound Guide	18	
Motorsports Compound Codes & Descriptions	19	
Motorsports Compound Performance Guides	20	
Circle Track Reference Guides	21	
Motorsports FAQs	22	
Brake Pad Application Guide	24	
Specialty Caliper Cross Reference Guide	178	
Brake Pad Code Reference & Diagram Legend	182	
Brake Pad Diagrams	184	
FMSI Cross Reference	257	
Company History	259	

Superior Street Products By Design

At Hawk Performance we understand that brake pads are critical components that directly affect vehicle handling, safety and driver confidence. That's why our products are engineered to meet and exceed the braking demands of today's severe-duty & high

performance vehicle applications. Each Hawk Performance brand product incorporates advanced engineering design, world-class friction technology and premium-quality raw materials.

POWDER COAT & ZINC DICHROMATE PLATING

- Hawk's dual layer outer shell offers superior corrosion resistance and smooth brake engagement.
- Each backing plate is first coated with zinc dichromate. The finished part is later sealed with an Aerospace-grade, high-temperature, electrostatic powder coat.

FRICTION MATERIAL

- Hawk Performance's world-class friction formulations deliver superior stopping power and durability for any high-performance or severe-duty application.

SURFACE PREPARATION

- Diamond ground for exceptional surface conditioning and flatness.

SLOTTED FRICTION

- Adds friction flexibility to relieve stress.
- Aids in the removal of friction debris.

MECHANICAL RETENTION SYSTEM

- Hawk's mechanical bond/retention system features hundreds of small extruded hooks that are molded directly into the friction material. In terms of bond and shear strength, there is no better product.

BACKING LAYER

- Hawk incorporates a special backing material at the bond line that creates a micro heat shield and optimizes bond strength.

STEEL BACKING PLATE

- Engineered to meet Original Equipment design for fitment.
- Hawk's mono-block backing plate design increases flexural strength, and provides superior braking engagement.

HOT BOND SHIM

- Hawk's advance engineered shims feature a single layer of steel with a high-temperature rubber coating. Each shim is designed to dampen noise and hot bonded to eliminate delamination.

PAD CHAMFER

- Engineered to eliminate noise and vibration.
- Improves brake engagement quality.

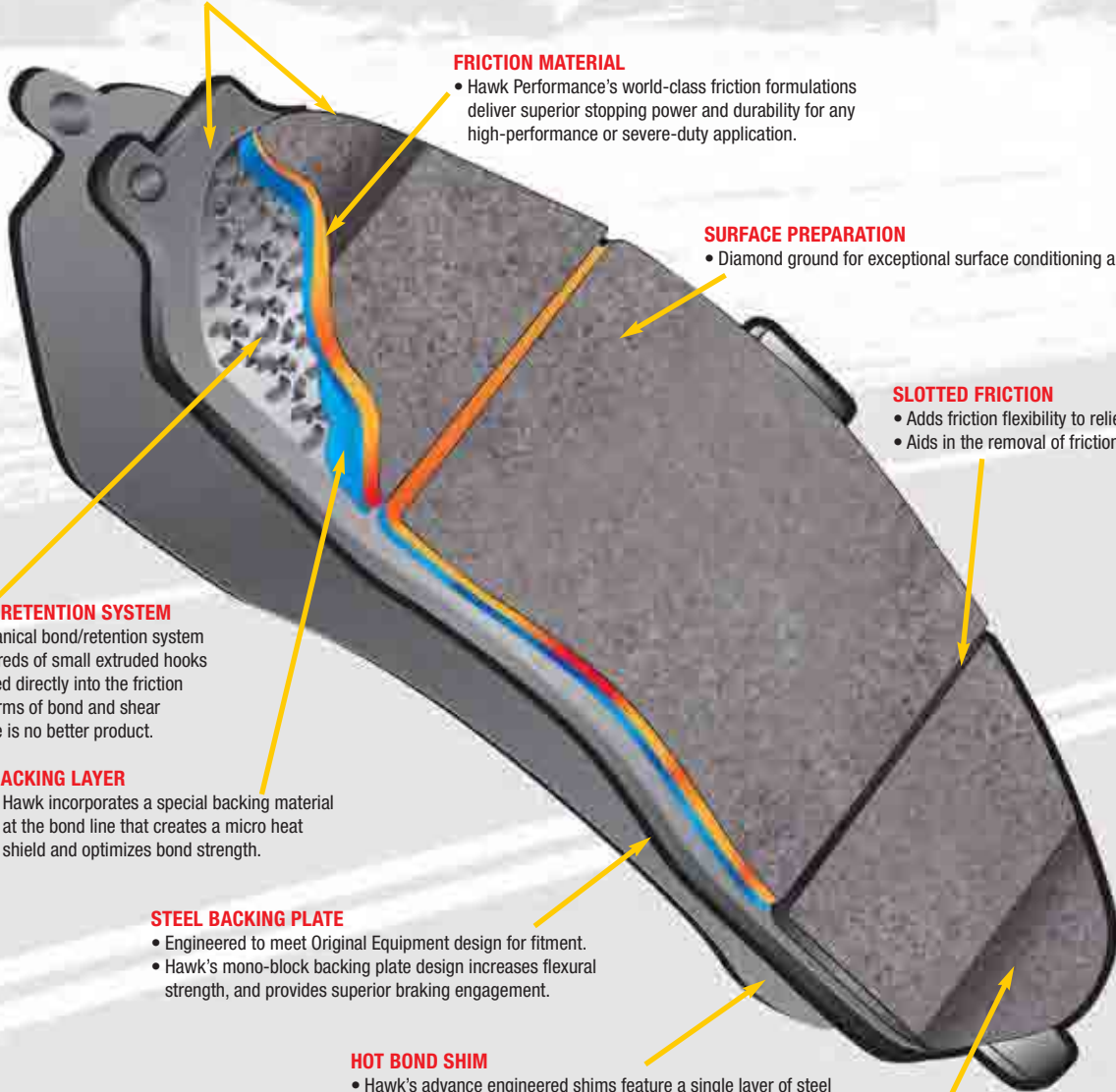

Hawk—The Solution for Better Braking Performance

Whether you drive in spirited fashion through canyon switchbacks or pull 20,000 lbs over 4,000-foot summits, Hawk Performance has engineered the right pad friction compound for your street performance goals.

Selecting the right product for your specific car or truck is critical. The graphs to the right illustrate the performance ratings of our street products. Each graph represents a vehicle group and the product rating for the following key characteristics.

- Stopping Power
- Rotor & Pad Wear
- Noise
- Dust

The Hawk Advantage:

- 20-40% more stopping power than stock pads
- Quick warm-up
- Strong, balanced initial bite
- Superior fade resistance
- Low dust properties
- Rotor friendly—will not shorten rotor life
- Outlast stock brake pads
- Lifetime warranty

Reference pages 6 to 9 for complete street product line descriptions. For make, model and year applications guide turn to page 24. If you have purchased a conversion brake kit or non-OE caliper, use our “specialty caliper guide” on page 178.

Do You Race? Hawk Performance has over ten application-specific race pad compounds for practically any form of Motorsports. Please refer to page 14 for an introduction to our comprehensive line of Motorsports products & applications.

Hawk Performance Product Rating Guide* (Street Brake Pads)

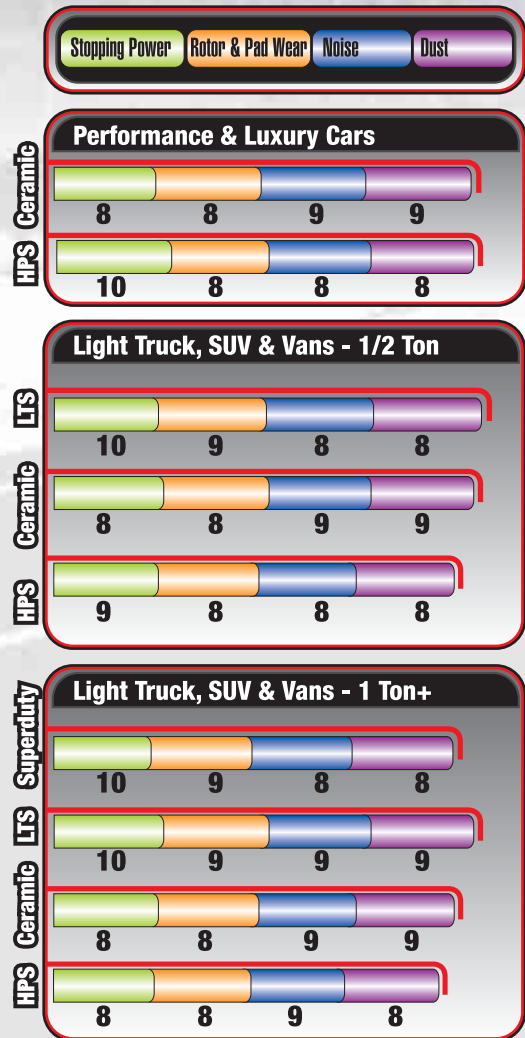

Performance Rating: 1=Poor 10=Excellent (for each category listed above)

*Performance ratings are provided as a general recommendation. Actual performance ratings of any given product will vary as vehicle applications change.

CODE Breakdown

HB 245 x .631

Hawk Performance Brake Pads Hawk Pad Shape Insert Compound Code Overall Thickness (in inches)

Street Compounds

BRAKE PAD	COMPOUND CODE
HPS Performance Street	F
Performance Ceramic	Z
LTS Light Truck & SUV	Y
SuperDuty	P

>>> Race Proven. Street Legal. >>> Hawk Pad Technology. >>>



Results based on A04D Dyno tests using D52 automotive platform.
Actual on-vehicle performance may vary.



Ideal for import & domestic automobiles.

HPS-High Performance Street

When it comes to performance braking for street vehicles, there is no equal.

Superior Stopping Power For The Street

HPS - (High Performance Street) disc brake pads are world-renowned for increasing stopping power on your street legal vehicle. Hawk Performance's engineers developed the HPS compound by blending the safety and quality aspects of Aerospace design with braking technology derived from Motorsports efforts. The result is a unique Ferro-Carbon brake compound that delivers significant advantages of increased stopping power, extended pad life, extended rotor life and low dust properties for street applications.

Our high performance street compound offers a higher coefficient of friction over stock brake pads and can provide you 20-40% more stopping power, with higher resistance to brake fade than standard replacement pads.

HPS Brake Pad Key Features:

- Increased stopping power
- High friction/torque hot or cold
- Gentle on rotors
- Extended pad life
- Low dust
- Virtually noise-free
- Ideal for import & domestic automobiles

All Hawk Performance street brake pads provide a limited lifetime warranty, ensuring products to be free of defects from manufacturer's workmanship and materials. Please see page 11 for complete warranty information.

Important Installation Instructions

All brake pads require a burnishing or bedding-in procedure in order to achieve optimal performance and durability. During the bedding-in process the pad conforms to the rotor surface and generates an import transfer film. Prior to installation, make sure the brake system is free and clear of debris, brake fluid is replaced and all brake components are properly installed and in good working order. See the FAQ section on page 10 for more information on proper brake pad bedding procedure.

PERFORMANCE CERAMIC-Luxury & Touring

Quiet, clean and quick stopping Performance Ceramic is better than standard replacement ceramic brake pads.

Quiet, Clean Performance

Hawk understands the demands of today's ceramic brake pad users, and specifically formulated our ceramic composite material to meet the ultra-low dust, low noise performance of OE ceramic pads. The advantage of our performance ceramic compound is that we don't sacrifice stopping power in order to achieve the traditional ceramic pad attributes. Additionally, our ceramic product provides a linear friction profile which allows your ABS system to operate more effectively.

Performance Ceramic Brake Pad Key Features:

- Extremely quiet—engineered to reduce brake NVH (Noise, Vibration and Harshness)
- Increased stopping power
- Increased rotor life
- Extended pad life
- Ultra-low dust
- Stable friction output
- Ideal for import and domestic sportscars and luxury cars, sport trucks, vans and SUV's with light towing and hauling duty

Important Installation Instructions

All brake pads require a burnishing or bedding-in procedure in order to achieve optimal performance and durability. During the bedding-in process the pad conforms to the rotor surface and generates an import transfer film. Prior to installation, make sure the brake system is free and clear of debris, brake fluid is replaced and all brake components are properly installed and in good working order. See the FAQ section on page 10 for more information on proper brake pad bedding procedure.



Results based on A04D Dyno tests using D52 automotive platform. Actual on-vehicle performance may vary.

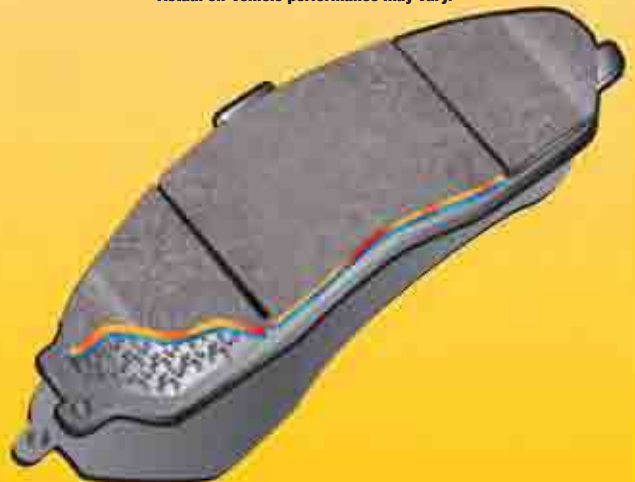

Recommended for import & domestic automobiles, luxury SUV's, sport trucks & vans.



Results based on A04D Dyno tests using D655 1 ton truck platform.
Actual on-vehicle performance may vary.

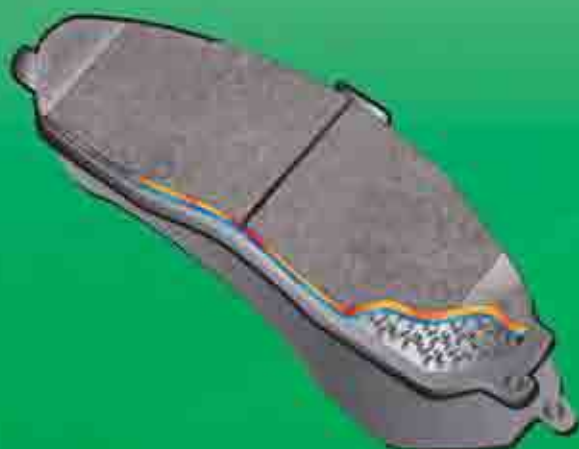

Ideal for import and domestic full-size trucks, SUV's and vans with moderate towing and hauling duty.

LTS-Light Truck & SUV

Stop putting car brakes on your truck. Hawk's LTS compound is specifically formulated for large brake systems found on full-size trucks and SUV's.

Engineered By Truck Brake Pad Experts

At Hawk Performance, we understand that traditional car brake pad technology just doesn't cut it on today's trucks. This is especially true if you haul heavy payloads or trailers. Install our LTS brake compound and dramatically improve your truck's stopping power and fade resistance. Additionally, Hawk Performance LTS compound will out last the competition in terms of rotor and pad wear.

What Makes Us The Truck Experts?

For over forty years, we have developed and supplied friction solutions for some of the largest trucks on the planet. Our products are utilized by both OE and aftermarket companies servicing the mining, construction, Military and commercial truck markets. We have utilized this technology and combined it with Aerospace design quality to develop the ultimate on-highway truck and SUV specific friction material.

LTS Brake Pad Key Features:

- Designed for large brake systems found on full-size trucks
- Engineered using technology from fleet & Military applications
- Ferro-Carbon friction material delivers more braking power and fade resistance than OE pads
- Low dust
- Excellent pad and rotor life
- Virtually noise-free
- Ideal for import and domestic full-size trucks, vans and SUV's (1/2 ton) with moderate towing and hauling duty

All Hawk Performance street brake pads provide a limited lifetime warranty, ensuring products to be free of defects from manufacturer's workmanship and materials. Please see page 11 for complete warranty information.

Important Installation Instructions

All brake pads require a burnishing or bedding-in procedure in order to achieve optimal performance and durability. During the bedding-in process the pad conforms to the rotor surface and generates an import transfer film. Prior to installation, make sure the brake system is free and clear of debris, brake fluid is replaced and all brake components are properly installed and in good working order. See the FAQ section on page 10 for more information on proper brake pad bedding procedure.

SUPERDUTY - Severe-Duty Truck

For serious towing/hauling and commercial truck fleets.

Unequaled For Severe Duty Use

Hawk Performance SuperDuty brake pads utilize our OE and aftermarket severe-duty friction technology. This product has been engineered for class 2 and higher on-highway commercial trucks. This unique Ferro-Carbon material delivers extremely high fade resistance, with superior high temperature rotor and brake pad wear. **This product is not recommended for personal or recreational trucks and SUV's.**

SuperDuty Brake Pad Key Features:

- Engineered from technology used in heavy-duty on/off-highway and military applications
- Extremely high coefficient of friction and fade resistance
- Recommended for professional fleets (greater than 1 ton) and light trucks towing excessive payloads

Important Installation Instructions

See page 10 for proper brake pad bedding procedures.



HP PLUS - Autocross & Racing

For import and domestic streetcars that compete in Autocross, Solo and Track Day competition.

The Ultimate Double Duty Friction Compound

Hawk's HP Plus race compound can take the heat of the track, and get you home safely without having to change back to street brake pads. HP Plus was developed and manufactured for sport driving in Track Day applications. This friction formulation offers lower wear rates and higher torque values than other competitive materials.

HP Plus Brake Pad Key Features:

- Extremely high friction output
- Extremely high fade resistance

WARNING! Due to the dramatic friction levels produced by this product to achieve "race-level" braking, rotor wear, noise, dust, and pad life may be affected. All Hawk Performance HP Plus / Autocross brake pads provide a limited lifetime warranty, ensuring products to be free of defects from manufacturer's workmanship and materials. Please see page 11 for complete warranty information.

Important Installation Instructions

See page 23 for proper HP Plus brake pad bedding procedures.



Motorsports Pad Introduction begins on page 14!

Racing Partnerships

Hawk Performance is dedicated to manufacturing the absolute best Motorsports brake pads in the World. To ensure this, we go beyond our laboratory and in-house dynamometer testing and work directly with championship race teams, professional racing organizations and advanced

driving schools to test and improve our products. This immediate, unfiltered feedback from trusted industry experts helps drive the creation of next generation products that will meet the needs of a constantly evolving Motorsports market.



SCCA

Hawk Performance is the Official Brake Product of the Sports Car Club of America (SCCA). The SCCA is the largest race sanctioning body in the United States, with over 55,000 members who compete in over 2,000 events in Road Racing, Autocross and Rallying.

NASA

Hawk Performance is the Official Brake Product of the National Auto Sport Association (NASA). NASA is the fastest growing sanctioning body for amateur Motorsports in the country and offers many innovative programs that allow drivers of all experience levels to enjoy distinct disciplines such as High Performance Driving Events (HPDE), Rally, Time Trial, NASA-X and Competition Racing at over 500 events per year nationwide at premier venues.



USAR Hooters Pro Cup Series

Hawk Performance is a proud contingency sponsor for the USAR Hooters Pro Cup Series. This series has become one of the most talked about racing programs in the nation and has experienced phenomenal growth in just 10 years, growing from 11 races during its first season to a 21-race, two division schedule.

GRAND AM

Grand-Am Road Racing, which operates and sanctions the Rolex Sports Car Series and the KONI Challenge Series, is the premier Road Racing organization in North America. The 13-race Rolex Series 2009 schedule and the 12-race KONI Challenge Series 2009 calendar delivers professional sports car racing to key markets throughout North America in addition to being televised in the United States and Canada on SPEED channel and distributed globally through ESPN International. With title sponsorship support from Rolex Watch USA and presenting sponsorship from Crown Royal Cask No. 16, the Rolex Series showcases emerging and legendary drivers from around the globe and thoroughbred racing machines from the industry's leading constructors and the World's top automobile manufacturers. Learn more about Grand-Am at www.grand-am.com.

PROUD CONTINGENCY PARTNER OF



CHAMPION RACING ASSOCIATION (CRA)

Hawk Performance is the Official Brake Pad and a proud Contingency Sponsor of the CRA Super Series for Super Late Model stock cars. In 2008, the Super Series ran 18 races at 13 different racetracks in Indiana, Michigan, Ohio, Tennessee and Georgia with over 200 different drivers and over 120,000 people in attendance. CRA-sanctioned races are held on tracks less than ½ mile in length and are typically 125 laps long, with some special events running up to 400 laps.

INTERNATIONAL MOTOR CONTEST ASSOCIATION (IMCA)

The International Motor Contest Association (IMCA), organized in 1915, is the oldest active automobile racing sanctioning body in the United States. This highly successful series focuses on affordable professional racing with strict adherence to regulations, with divisions for Modifieds, Late Models, Stock Cars and Sprint Cars. Hawk Performance is a proud contingency sponsor of the IMCA.



LUCAS OIL DIRT SERIES

The Lucas Oil Late Model Dirt Series was founded in 2005. Racers compete in 2,300 lbs. Dirt Late Model cars, powered by 800 horsepower engines that turn in excess of 9,000 RPM. The Lucas Oil Dirt Series sanctioned 44 events in 16 states with a Series record \$2.9 million dollars paid out in event purses, championship point fund and bonus money in 2008. Hawk Performance is a proud contingency sponsor of the Lucas Oil Dirt Series.

COMPOUND	REMARKS	APPLICATIONS
DTC-70 Letter Code U	<ul style="list-style-type: none"> • 400-1600°F; 204-871°C • High Temp & High Torque • Provides Superior Pad and Disc Wear • Excellent Torque Control • Excellent Modulation and Release Characteristics • Designed for High Deceleration Rates • Supercedes HT 15 material 	<ul style="list-style-type: none"> • NASCAR/NASCAR Modified • Hooters Cup • ARCA • ASA • Super Late Models • CORR Pro2/Pro4 • Pavement Street Stock • Sports Car/GT/GS/ All Club Levels • Open Wheel/Formula • Monster Trucks
DTC-60 Letter Code G Note: Slightly lower torque than DTC-70 - Recommended for use with DTC-70 when split friction between front and rear axle is desired	<ul style="list-style-type: none"> • 400-1600°F; 204-871°C • High Temp & High Torque • Provides Superior Pad and Disc Wear • Excellent Torque Control • Excellent Modulation and Release Characteristics 	<ul style="list-style-type: none"> • NASCAR/NASCAR Modified • Hooters Cup • ARCA • ASA • Super Late Models • Pavement Street Stock • CORR Pro2/Pro4 • Sports Car/GT/GS/ All Club Levels • Open Wheel/Formula • Popular choice on lightweight front axle apps w/ or w/out ABS • Monster Trucks
DTC-30 Letter Code W	<ul style="list-style-type: none"> • 100-1200°F; 38-649°C • Wide Temp Range • Controllable Torque • Smooth Feel and Bite • Excellent Release Characteristics • Superior Static and Dynamic Coefficient of Friction for Drag Cars with Cast Iron Rotors • Excellent Rotor Wear 	<ul style="list-style-type: none"> • Dirt Circle Track • Popular choice for use on many rear axle apps w/ABS (limited availability) • Dirt Late Model & Modified • Off-Road Prolite • Dirt Street Stock • NASCAR Modified • Specialty calipers used in med- to high-deceleration Drag Racing • Midget • USAC • Dirt Wing/Non Wing Sprint Cars
DTC-05 Letter Code H	<ul style="list-style-type: none"> • 100-900°F; 38-482°C • Low to Mid Temp • Smooth Predictable Torque • Designed to Provide Lower Torque 	<ul style="list-style-type: none"> • Dirt Circle Track • Autocross/Track Day Events • Dirt Track Late Model • Dirt Late Model & Modified • Specialty Caliper and Brake Kit • Dirt Street Stocks (under 2,800 lbs)
HT-14 Letter Code V Note: See DTC-60 and DTC-70 for latest material development	<ul style="list-style-type: none"> • 300-1400°F; 149-871°C • High Temp • High Torque • Designed for High Deceleration Rates • Designed for High Momentum Dirt Tracks 	<ul style="list-style-type: none"> • Sports Car/GT • Open Wheel/Formula • Dirt Late Model • Dirt Track Late Model • Dirt Street Stock (under 2800 lbs) • F2000 • F3000
HT-10 Letter Code S Note: See DTC-60 for latest material development	<ul style="list-style-type: none"> • 300-1300°F; 149-871°C • High Temp • Intermediate to High Torque • Medium Temp 	<ul style="list-style-type: none"> • Road Racing for Higher Torque than Blue 9012 • Pavement Circle Track • Increased Track Day Performance
MT-4 Letter Code L Note: See DTC-60 and DTC-70 for latest material development	<ul style="list-style-type: none"> • 400-1200°F; 204-649°C • Mid to High Temp • Intermediate to High Torque 	<ul style="list-style-type: none"> • Pavement Circle track (under 2800 lbs) • Pavement Street Stock (under 2800 lbs) • NASCAR Modified • Pavement Limited Late Model • Pavement Modified
Blue 9012 Letter Code E Note: See DTC-60 for latest material development	<ul style="list-style-type: none"> • 250-1000°F; 121-538°C • Low to Mid Temp • Low to Intermediate Torque • Excellent Modulation • Multi-purpose compound 	<ul style="list-style-type: none"> • Road and Rally Racing
Black Letter Code M	<ul style="list-style-type: none"> • 100-900°F; 38-482°C • Lower Temp • Low to Intermediate Torque 	<ul style="list-style-type: none"> • Dirt Circle Track • Low Cost, All-Purpose Compound • For Lower Temp and Torque Applications
DR-97 Letter Code J	<ul style="list-style-type: none"> • 100-900°F; 38-482°C • Good Static and Dynamic Coefficient of Friction 	<ul style="list-style-type: none"> • Specialty Calipers used in Low- to Medium-Deceleration Drag Racing
HP Plus Letter Code N WARNING: Due to this product's dramatic friction levels, the user may notice increased noise, dust and pad and rotor wear	<ul style="list-style-type: none"> • 100-800°F; 38-482°C • Wide Temp Range • Exceptional Stopping Performance • Designed to get you to and from the track without requiring brake change 	<ul style="list-style-type: none"> • Autocross • Club Track Day Events • Popular Choice for Rear Axle use on GT, GS and Club Level Applications with ABS • Dirt Crate Late Model

Motorsports Compound Codes

Below are descriptions of the available compounds for Hawk Performance Motorsports brake pad compounds:

DTC-70

Extremely high torque with aggressive controllable initial bite. Superior release and torque control characteristics. Brake pads designed for cars with high deceleration rates, with or without down force, on non-ABS-sensitive applications.

DTC-60

High torque with less initial bite than DTC-70. Superior release and torque control characteristics. Brake pads designed for cars with high deceleration rates, with or without down force. Recommended for use with DTC-70 when split friction between front and rear axle is desired on non-ABS-equipped applications. Popular choice for use on lighter weight front axle applications, with or without ABS.

DTC-30

Brake pads designed to meet the demands of Open Wheel and Dirt Circle Track racing. Uniquely controllable torque with smooth consistent feel and bite. Superior release and torque control characteristics.

DTC-05

Developed specifically to meet the demands of Dirt Track racing on high momentum race tracks where high torque is not necessary. Excellent pad for hard spec-tire racing. This friction formulation provides very controllable, higher-temperature performance compared to stock pads.

HT-10

Intermediate to high torque with a smooth initial bite. Very consistent pedal feel. Excellent modulation and release characteristics.

Blue 9012

Medium to high torque and temperature compound, with excellent brake modulation.

MT-4

Medium to high torque and temperature compound, with medium to high initial bite. Brake pads designed for Circle Track cars under 2800 lbs, without high deceleration rates.

Black

Medium torque and temperature compound designed to be a good, all-purpose, low-cost racing brake pad.

DR-97

Good static coefficient of friction on cast iron rotors. Smooth linear torque. Low pad and rotor wear. Brake pads specifically designed for use in drag racing applications.

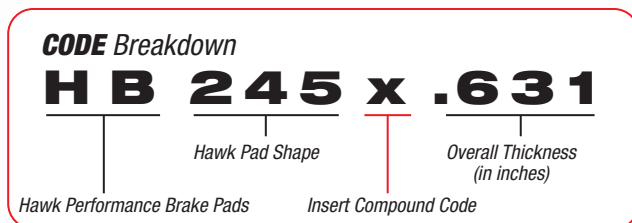

Motorsports Compound

BRAKE PAD	COMPOUND CODE
DTC-70	U
DTC-60	G
DTC-30	W
DTC-05	H
HT-14	V
HT-10	S
MT-4	L
Blue 9012	E
Black	M
DR-97	J
HP Plus	N



The key to our success has been, and continues to be, our passion to develop leading-edge product technologies and maintain our position as the global market leader. Our premier DTC product line is a direct result of our passion and commitment to Motorsports. When it comes to superior braking performance, our DTC product line has no equal.

ROAD RACE (FRONT AXLE APPLICATIONS)

RATING SCALE: 1 ■ = Fair, 5 ■ = Excellent

Vehicle Weight	Performance Categories	DTC-70	DTC-60	HT-14	HT-10	BLUE 9012	BLACK
Above 2800 lbs	Initial Torque	■■■■■	■■■■■	■■■■■	■■■■■	■■■■■	NOT RECOMMENDED
	Fade Resistance	■■■■■	■■■■■	■■■■■	■■■■■	■■■■■	NOT RECOMMENDED
	Release	■■■■■	■■■■■	■■■■■	■■■■■	■■■■■	NOT RECOMMENDED
	Consistency	■■■■■	■■■■■	■■■■■	■■■■■	■■■■■	NOT RECOMMENDED
	Modulation	■■■■■	■■■■■	■■■■■	■■■■■	■■■■■	NOT RECOMMENDED
	Pad Wear	■■■■■	■■■■■	■■■■■	■■■■■	■■■■■	NOT RECOMMENDED
	Disc Wear	■■■■■	■■■■■	■■■■■	■■■■■	■■■■■	NOT RECOMMENDED
Below 2800 lbs	Initial Torque	■■■■■	■■■■■	NOT RECOMMENDED	■■■■■	■■■■■	NOT RECOMMENDED
	Fade Resistance	■■■■■	■■■■■	NOT RECOMMENDED	■■■■■	■■■■■	NOT RECOMMENDED
	Release	■■■■■	■■■■■	NOT RECOMMENDED	■■■■■	■■■■■	NOT RECOMMENDED
	Consistency	■■■■■	■■■■■	NOT RECOMMENDED	■■■■■	■■■■■	NOT RECOMMENDED
	Modulation	■■■■■	■■■■■	NOT RECOMMENDED	■■■■■	■■■■■	NOT RECOMMENDED
	Pad Wear	■■■■■	■■■■■	NOT RECOMMENDED	■■■■■	■■■■■	NOT RECOMMENDED
	Disc Wear	■■■■■	■■■■■	NOT RECOMMENDED	■■■■■	■■■■■	NOT RECOMMENDED
Below 2300 lbs	Initial Torque	■■■■■	■■■■■	NOT RECOMMENDED	■■■■■	■■■■■	■■■■■
	Fade Resistance	■■■■■	■■■■■	NOT RECOMMENDED	■■■■■	■■■■■	■■■■■
	Release	■■■■■	■■■■■	NOT RECOMMENDED	■■■■■	■■■■■	■■■■■
	Consistency	■■■■■	■■■■■	NOT RECOMMENDED	■■■■■	■■■■■	■■■■■
	Modulation	■■■■■	■■■■■	NOT RECOMMENDED	■■■■■	■■■■■	■■■■■
	Pad Wear	■■■■■	■■■■■	NOT RECOMMENDED	■■■■■	■■■■■	■■■■■
	Disc Wear	■■■■■	■■■■■	NOT RECOMMENDED	■■■■■	■■■■■	■■■■■

ROAD RACE (REAR AXLE APPLICATIONS)

Vehicle Weight	Performance Categories	DTC-70	DTC-60	HT-10	BLUE 9012	BLACK	HPS or DTC-05
Above 2800 lbs	Initial Torque	■■■■■	■■■■■	■■■■■	■■■■■	■■■■■	■■■■■
	Fade Resistance	■■■■■	■■■■■	■■■■■	■■■■■	■■■■■	■■■■■
	Release	■■■■■	■■■■■	■■■■■	■■■■■	■■■■■	■■■■■
	Consistency	■■■■■	■■■■■	■■■■■	■■■■■	■■■■■	■■■■■
	Modulation	■■■■■	■■■■■	■■■■■	■■■■■	■■■■■	■■■■■
	Pad Wear	■■■■■	■■■■■	■■■■■	■■■■■	■■■■■	■■■■■
	Disc Wear	■■■■■	■■■■■	■■■■■	■■■■■	■■■■■	■■■■■
	Rear Lockup Resistance	■■■■■	■■■■■	■■■■■	■■■■■	■■■■■	■■■■■
Below 2800 lbs	Initial Torque	■■■■■	■■■■■	■■■■■	■■■■■	■■■■■	■■■■■
	Fade Resistance	■■■■■	■■■■■	■■■■■	■■■■■	■■■■■	■■■■■
	Release	■■■■■	■■■■■	■■■■■	■■■■■	■■■■■	■■■■■
	Consistency	■■■■■	■■■■■	■■■■■	■■■■■	■■■■■	■■■■■
	Modulation	■■■■■	■■■■■	■■■■■	■■■■■	■■■■■	■■■■■
	Pad Wear	■■■■■	■■■■■	■■■■■	■■■■■	■■■■■	■■■■■
	Disc Wear	■■■■■	■■■■■	■■■■■	■■■■■	■■■■■	■■■■■
	Rear Lockup Resistance	■■■■■	■■■■■	■■■■■	■■■■■	■■■■■	■■■■■
Below 2300 lbs	Initial Torque	■■■■■	■■■■■	■■■■■	■■■■■	■■■■■	■■■■■
	Fade Resistance	■■■■■	■■■■■	■■■■■	■■■■■	■■■■■	■■■■■
	Release	■■■■■	■■■■■	■■■■■	■■■■■	■■■■■	■■■■■
	Consistency	■■■■■	■■■■■	■■■■■	■■■■■	■■■■■	■■■■■
	Modulation	■■■■■	■■■■■	■■■■■	■■■■■	■■■■■	■■■■■
	Pad Wear	■■■■■	■■■■■	■■■■■	■■■■■	■■■■■	■■■■■
	Disc Wear	■■■■■	■■■■■	■■■■■	■■■■■	■■■■■	■■■■■
Rear Lockup Resistance	NOT RECOMMENDED	■■■■■	■■■■■	■■■■■	■■■■■	■■■■■	

***Note: Cars equipped with ABS systems may require additional compound information. Contact a Hawk Representative.

PAVEMENT CIRCLE TRACK

Category	HAWK Standard Compounds	HAWK Upgrade Compounds	PFC Compounds	Wilwood Compounds
Late Model	HT-15	DTC-70	PFC-01	Poly-A
	HT-10	DTC-60	PFC-97	Poly-B
	MT-4	DTC-30	PFC-93	
Whelen Style Modified	HT-15	DTC-70	PFC-01	Poly-A
	MT-4	DTC-30	PFC-97	Poly-B
IMCA Style Modified	MT-4	DTC-30	PFC-01	Poly-A
	Black	DTC-30	PFC-97	Poly-B
Street Stock	MT-4	DTC-70	PFC-01	Poly-A
	Black	DTC-30	PFC-97	Poly-B

DIRT CIRCLE TRACK

Category	HAWK Standard Compounds	HAWK Upgrade Compounds	PFC Compounds	Wilwood Compounds
Late Model	Black	DTC-30	PFC-97	Poly-B
	Black	DTC-30	PFC-93	
	MT-4	DTC-70	PFC-01	Poly-A
	HPS	DTC-05	PFC-83	Poly-D
	HPS	DTC-05		Poly-E
Modified	Black	DTC-30		Poly-B
	HPS	DTC-05	PFC-80	Poly-D/Poly-E
Wing Sprint Car				
Steel Rotor	Black	DTC-30		Poly-B
Aluminum Rotor	DR-97	DTC-30		Poly-Q
Titanium Rotor		DTC-30		*Red Devil Metallic Pad

OPEN WHEEL/FORMULA CAR

(FRONT AXLE APPLICATIONS) **RATING SCALE: 1 ■ = Fair, 5 ■ = Excellent**

Vehicle Weight	Performance Categories	DTC-70	HT-14	DTC-60	BLUE 9012	BLACK
Above 1100 lbs	Initial Torque	■ ■ ■ ■ ■	■ ■ ■ ■ ■	■ ■ ■ ■ ■	■ ■ ■ ■ ■	■ ■ ■ ■ ■
	Fade Resistance	■ ■ ■ ■ ■	■ ■ ■ ■ ■	■ ■ ■ ■ ■	■ ■ ■ ■ ■	■ ■ ■ ■ ■
	Release	■ ■ ■ ■ ■	■ ■ ■ ■ ■	■ ■ ■ ■ ■	■ ■ ■ ■ ■	■ ■ ■ ■ ■
	Consistency	■ ■ ■ ■ ■	■ ■ ■ ■ ■	■ ■ ■ ■ ■	■ ■ ■ ■ ■	■ ■ ■ ■ ■
	Modulation	■ ■ ■ ■ ■	■ ■ ■ ■ ■	■ ■ ■ ■ ■	■ ■ ■ ■ ■	■ ■ ■ ■ ■
	Pad Wear	■ ■ ■ ■ ■	■ ■ ■ ■ ■	■ ■ ■ ■ ■	■ ■ ■ ■ ■	■ ■ ■ ■ ■
	Disc Wear	■ ■ ■ ■ ■	■ ■ ■ ■ ■	■ ■ ■ ■ ■	■ ■ ■ ■ ■	■ ■ ■ ■ ■
	Initial Torque	■ ■ ■ ■ ■	■ ■ ■ ■ ■	■ ■ ■ ■ ■	■ ■ ■ ■ ■	■ ■ ■ ■ ■
Below 1100 lbs	Fade Resistance	■ ■ ■ ■ ■	■ ■ ■ ■ ■	■ ■ ■ ■ ■	■ ■ ■ ■ ■	■ ■ ■ ■ ■
	Release	■ ■ ■ ■ ■	■ ■ ■ ■ ■	■ ■ ■ ■ ■	■ ■ ■ ■ ■	■ ■ ■ ■ ■
	Consistency	■ ■ ■ ■ ■	■ ■ ■ ■ ■	■ ■ ■ ■ ■	■ ■ ■ ■ ■	■ ■ ■ ■ ■
	Modulation	■ ■ ■ ■ ■	■ ■ ■ ■ ■	■ ■ ■ ■ ■	■ ■ ■ ■ ■	■ ■ ■ ■ ■
	Pad Wear	■ ■ ■ ■ ■	■ ■ ■ ■ ■	■ ■ ■ ■ ■	■ ■ ■ ■ ■	■ ■ ■ ■ ■
	Disc Wear	■ ■ ■ ■ ■	■ ■ ■ ■ ■	■ ■ ■ ■ ■	■ ■ ■ ■ ■	■ ■ ■ ■ ■
	Initial Torque	■ ■ ■ ■ ■	■ ■ ■ ■ ■	■ ■ ■ ■ ■	■ ■ ■ ■ ■	■ ■ ■ ■ ■
	Below 900 lbs	Fade Resistance	■ ■ ■ ■ ■	■ ■ ■ ■ ■	■ ■ ■ ■ ■	■ ■ ■ ■ ■
Release		■ ■ ■ ■ ■	■ ■ ■ ■ ■	■ ■ ■ ■ ■	■ ■ ■ ■ ■	■ ■ ■ ■ ■
Consistency		■ ■ ■ ■ ■	■ ■ ■ ■ ■	■ ■ ■ ■ ■	■ ■ ■ ■ ■	■ ■ ■ ■ ■
Modulation		■ ■ ■ ■ ■	■ ■ ■ ■ ■	■ ■ ■ ■ ■	■ ■ ■ ■ ■	■ ■ ■ ■ ■
Pad Wear		■ ■ ■ ■ ■	■ ■ ■ ■ ■	■ ■ ■ ■ ■	■ ■ ■ ■ ■	■ ■ ■ ■ ■
Disc Wear		■ ■ ■ ■ ■	■ ■ ■ ■ ■	■ ■ ■ ■ ■	■ ■ ■ ■ ■	■ ■ ■ ■ ■
Initial Torque		■ ■ ■ ■ ■	■ ■ ■ ■ ■	■ ■ ■ ■ ■	■ ■ ■ ■ ■	■ ■ ■ ■ ■
Fade Resistance		■ ■ ■ ■ ■	■ ■ ■ ■ ■	■ ■ ■ ■ ■	■ ■ ■ ■ ■	■ ■ ■ ■ ■

OPEN WHEEL/FORMULA CAR

(REAR AXLE APPLICATIONS)

Vehicle Weight	Performance Categories	DTC-60	HT-14	HT-10	BLUE 9012	BLACK
Above 1000 lbs	Initial Torque	■ ■ ■ ■ ■	■ ■ ■ ■ ■	■ ■ ■ ■ ■	■ ■ ■ ■ ■	■ ■ ■ ■ ■
	Fade Resistance	■ ■ ■ ■ ■	■ ■ ■ ■ ■	■ ■ ■ ■ ■	■ ■ ■ ■ ■	■ ■ ■ ■ ■
	Release	■ ■ ■ ■ ■	■ ■ ■ ■ ■	■ ■ ■ ■ ■	■ ■ ■ ■ ■	■ ■ ■ ■ ■
	Consistency	■ ■ ■ ■ ■	■ ■ ■ ■ ■	■ ■ ■ ■ ■	■ ■ ■ ■ ■	■ ■ ■ ■ ■
	Modulation	■ ■ ■ ■ ■	■ ■ ■ ■ ■	■ ■ ■ ■ ■	■ ■ ■ ■ ■	■ ■ ■ ■ ■
	Pad Wear	■ ■ ■ ■ ■	■ ■ ■ ■ ■	■ ■ ■ ■ ■	■ ■ ■ ■ ■	■ ■ ■ ■ ■
	Disc Wear	■ ■ ■ ■ ■	■ ■ ■ ■ ■	■ ■ ■ ■ ■	■ ■ ■ ■ ■	■ ■ ■ ■ ■
	Rear Lockup Resistance	■ ■ ■ ■ ■	■ ■ ■ ■ ■	■ ■ ■ ■ ■	■ ■ ■ ■ ■	■ ■ ■ ■ ■
Below 1000 lbs	Initial Torque	■ ■ ■ ■ ■	■ ■ ■ ■ ■	■ ■ ■ ■ ■	■ ■ ■ ■ ■	■ ■ ■ ■ ■
	Fade Resistance	■ ■ ■ ■ ■	■ ■ ■ ■ ■	■ ■ ■ ■ ■	■ ■ ■ ■ ■	■ ■ ■ ■ ■
	Release	■ ■ ■ ■ ■	■ ■ ■ ■ ■	■ ■ ■ ■ ■	■ ■ ■ ■ ■	■ ■ ■ ■ ■
	Consistency	■ ■ ■ ■ ■	■ ■ ■ ■ ■	■ ■ ■ ■ ■	■ ■ ■ ■ ■	■ ■ ■ ■ ■
	Modulation	■ ■ ■ ■ ■	■ ■ ■ ■ ■	■ ■ ■ ■ ■	■ ■ ■ ■ ■	■ ■ ■ ■ ■
	Pad Wear	■ ■ ■ ■ ■	■ ■ ■ ■ ■	■ ■ ■ ■ ■	■ ■ ■ ■ ■	■ ■ ■ ■ ■
	Disc Wear	■ ■ ■ ■ ■	■ ■ ■ ■ ■	■ ■ ■ ■ ■	■ ■ ■ ■ ■	■ ■ ■ ■ ■
	Rear Lockup Resistance	■ ■ ■ ■ ■	■ ■ ■ ■ ■	■ ■ ■ ■ ■	■ ■ ■ ■ ■	■ ■ ■ ■ ■

CODE Breakdown

HB 245 x .631

Insert Compound Code

Make/Model	Submodel	Engine (Liter)	Years	Note	FRONT		REAR	
					Hawk #	FMSI	Hawk #	FMSI
ACURA								
CL	Type-S	3.2	2001-2003		HB366x.681	D787	HB145x.570	D537
CL		2.2	1997-1997	w/Drum Style Parking Brake	HB275x.620	D465	HB145x.570	D537
CL		2.3	1998-1999	w/Drum Style Parking Brake	HB275x.620	D465	HB145x.570	D537
CL		3.0	1997-1999	w/Drum Style Parking Brake	HB143x.680	D503	HB145x.570	D537
CL		3.2	2001-2003	w/Drum Style Parking Brake	HB366x.681	D787	HB145x.570	D537
CL		3.2	2001-2003	w/Integrated Parking Brake	HB366x.681	D787	HB572x.570	D536
Integra	GS	1.8	1990-1993		HB242x.661	D409	HB350x.496	D374
Integra	GS	1.8	1997-2001		HB245x.631	D617	HB350x.496	D374
Integra	GSR	1.7	1992-1993		HB242x.661	D409	HB350x.496	D374
Integra	GSR	1.8	1994-2001		HB245x.631	D617	HB350x.496	D374
Integra	LS	1.6	1986-1989		HB403x.587	D334		
Integra	LS	1.8	1990-1993		HB242x.661	D409	HB350x.496	D374
Integra	LS	1.8	1994-2001		HB245x.631	D617	HB350x.496	D374
Integra	RS	1.6	1986-1989		HB403x.587	D334		
Integra	RS	1.8	1990-1993		HB242x.661	D409	HB350x.496	D374
Integra	RS	1.8	1994-1998		HB245x.631	D617	HB350x.496	D374
Integra	SE	1.6	1988-1988		HB403x.587	D334		
Integra	Special Edition	1.8	1995-1996		HB245x.631	D617	HB350x.496	D374
Integra	Special Edition LS	1.6	1987-1987		HB403x.587	D334		
Integra	Type-R	1.8	1997-1998		HB143x.680	D503	HB145x.570	D537
Integra	Type-R	1.8	2000-2001		HB143x.680	D503	HB145x.570	D537
Legend	GS	3.2	1994-1995	w/Drum Style Parking Brake	HB143x.680	D503	HB145x.570	D537
Legend	GS	3.2	1994-1995	w/Integrated Parking Brake	HB143x.680	D503	HB572x.570	D536
Legend	L	2.5	1987-1987		HB242x.661	D409		
Legend	L	2.7	1987-1990		HB242x.661	D409		
Legend	L	3.2	1991-1995	w/Drum Style Parking Brake	HB143x.680	D503	HB145x.570	D537
Legend	L	3.2	1991-1995	w/Integrated Parking Brake	HB143x.680	D503	HB572x.570	D536
Legend	LS	2.7	1987-1990		HB242x.661	D409		
Legend	LS	3.2	1991-1995	w/Drum Style Parking Brake	HB143x.680	D503	HB145x.570	D537
Legend	LS	3.2	1991-1995	w/Integrated Parking Brake	HB143x.680	D503	HB572x.570	D536
Legend	SE	3.2	1995-1995	w/Drum Style Parking Brake	HB143x.680	D503	HB145x.570	D537
Legend	SE	3.2	1995-1995	w/Integrated Parking Brake	HB143x.680	D503	HB572x.570	D536
Legend		2.5	1986-1987		HB242x.661	D409		
Legend		2.7	1987-1990		HB242x.661	D409		
Legend		3.2	1991-1993	w/Drum Style Parking Brake	HB143x.680	D503	HB145x.570	D537
Legend		3.2	1991-1993	w/Integrated Parking Brake	HB143x.680	D503	HB572x.570	D536
MDX	Touring	3.5	2001-2002		HB386x.669	D793	HB506x.610	D865
MDX	Touring	3.5	2003-2006		HB326x.646	D691	HB506x.610	D865
MDX		3.5	2001-2002		HB386x.669	D793	HB506x.610	D865
MDX		3.5	2003-2006		HB326x.646	D691	HB506x.610	D865
NSX	Alex Zanardi	3.2	1999-1999		HB143x.680	D503	HB185x.590	D504
NSX	T	3.0	1995-1999		HB143x.680	D503	HB185x.590	D504
NSX	T	3.2	1997-1999		HB143x.680	D503	HB185x.590	D504
NSX		3.0	1991-2005		HB143x.680	D503	HB185x.590	D504
NSX		3.2	1997-2005		HB143x.680	D503	HB185x.590	D504
RL		3.5	1996-1998	w/Drum Style Parking Brake	HB143x.680	D503	HB145x.570	D537
RL		3.5	1996-1998	w/Integrated Parking Brake	HB143x.680	D503	HB572x.570	D536
RL		3.5	1999-2004	w/Drum Style Parking Brake	HB366x.681	D787	HB145x.570	D537
RL		3.5	1999-2004	w/Integrated Parking Brake	HB366x.681	D787	HB572x.570	D536
RSX	Type-S	2.0	2002-2005		HB361x.622	D829		
RSX	Type-S	2.0	2006-2006		HB361x.622	D829	HB145x.570	D537
RSX		2.0	2003-2006		HB418x.646	D621	HB145x.570	D537

RACE COMPOUND CODES

DTC-70 - U | DTC-05 - H | MT-4 - L | DR-97 - J
 DTC-60 - G | HT-14 - V | Blue 9012 - E | HP Plus - N
 DTC-30 - W | HT-10 - S | Black - M

STREET COMPOUND CODES

HPS Performance Street - F | SuperDuty - P
 Performance Ceramic - Z
 LTS Light Truck & SUV - Y

Make/ Model	Submodel	Engine		Note	FRONT		REAR	
		(Liter)	Years		Hawk #	FMSI	Hawk #	FMSI
ACURA CONT.								
SLX		3.2	1996-1997		HB422x.610	D579		
SLX		3.5	1998-1999		HB422x.610	D579		
TL	Type-S	3.2	2002-2003		HB530x.570	D1049	HB145x.570	D537
TL	Type-S	3.5	2007-2007		HB530x.570	D1049	HB572x.570	D536
TL	Type-S	3.5	2008-2008	w/Drum Style Parking Brake	HB530x.570	D1049	HB145x.570	D537
TL	Type-S	3.5	2008-2008	w/Integrated Parking Brake	HB530x.570	D1049	HB572x.570	D536
TL		2.5	1995-1998	w/Drum Style Parking Brake	HB143x.680	D503	HB145x.570	D537
TL		2.5	1995-1998	w/Integrated Parking Brake	HB143x.680	D503	HB572x.570	D536
TL		3.2	1996-1998	w/Drum Style Parking Brake	HB143x.680	D503	HB145x.570	D537
TL		3.2	1996-1998	w/Integrated Parking Brake	HB143x.680	D503	HB572x.570	D536
TL		3.2	1999-2006	w/Drum Style Parking Brake	HB366x.681	D787	HB145x.570	D537
TL		3.2	1999-2006	w/Integrated Parking Brake	HB366x.681	D787	HB572x.570	D536
TL		3.2	2007-2007		HB366x.681	D787	HB572x.570	D536
TL		3.2	2008-2008	w/Drum Style Parking Brake	HB366x.681	D787	HB145x.570	D537
TL		3.2	2008-2008	w/Integrated Parking Brake	HB366x.681	D787	HB572x.570	D536
TSX		2.4	2004-2008		HB366x.681	D787	HB145x.570	D537
Vigor	GS	2.5	1992-1994		HB143x.680	D503	HB145x.570	D537
Vigor	LS	2.5	1992-1994		HB143x.680	D503	HB145x.570	D537
ALFA ROMEO								
Alfetta	GT	2.0	1975-1977		HB172x.595	D31		
Alfetta	Sport	2.0	1975-1977		HB172x.595	D31		
Berlina		1.8	1969-1971		HB171x.590	D45		
Berlina		2.0	1970-1972		HB171x.590	D45		
GT Veloce		1.8	1969-1971		HB171x.590	D45		
GT Veloce		2.0	1972-1974		HB171x.590	D45		
GTV-6	2.5	2.5	1982-1982		HB171x.590	D45		
GTV-6	2.5	2.5	1984-1986		HB180x.640	D961		
Milano	Gold	2.5	1987-1989		HB180x.640	D961		
Milano	Platinum	2.5	1987-1988		HB180x.640	D961		
Milano	Silver	2.5	1987-1987		HB180x.640	D961		
Milano	Verde	3.0	1988-1989		HB180x.640	D961		
Spider	Graduate	2.0	1986-1990		HB180x.640	D961		
Spider	Quadrifoglio	2.0	1986-1990		HB180x.640	D961		
Spider	Veloce	2.0	1970-1982		HB171x.590	D45		
Spider	Veloce	2.0	1983-1990		HB180x.640	D961		
Spider		1.8	1969-1971		HB171x.590	D45		
Sprint	Veloce	2.0	1977-1979		HB172x.595	D31		
AMC								
Gremlin	Custom	3.8	1976-1976		HB292x.674	D50		
Gremlin	Custom	4.2	1976-1976		HB292x.674	D50		
Gremlin	Custom	5.0	1976-1976		HB292x.674	D50		
Gremlin		3.8	1975-1976		HB292x.674	D50		
Gremlin		4.2	1975-1976		HB292x.674	D50		
Gremlin		5.0	1973-1975		HB292x.674	D50		
Hornet	SportAbout	3.8	1975-1976		HB292x.674	D50		
Hornet	SportAbout	4.2	1975-1976		HB292x.674	D50		
Hornet	SportAbout	5.0	1973-1976		HB292x.674	D50		
Hornet	SportAbout	5.9	1973-1974		HB292x.674	D50		
Hornet		3.8	1975-1976		HB292x.674	D50		
Hornet		4.2	1975-1976		HB292x.674	D50		
Hornet		5.0	1973-1976		HB292x.674	D50		
Hornet		5.9	1973-1974		HB292x.674	D50		

CODE Breakdown

HB 245 x .631

Insert Compound Code

Make/Model	Submodel	Engine (Liter)	Years	Note	FRONT		REAR	
					Hawk #	FMSI	Hawk #	FMSI
AMC CONT.								
Matador		4.2	1975-1978		HB292x.674	D50		
Matador		5.0	1975-1977		HB292x.674	D50		
Matador		5.9	1975-1978		HB292x.674	D50		
Matador		6.6	1975-1976		HB292x.674	D50		
Pacer		3.8	1975-1976		HB292x.674	D50		
Pacer		4.2	1975-1976		HB292x.674	D50		
AUDI								
80		2.0	1988-1990		HB190x.730	D227	HB271x.635	D228
80		2.0	1988-1990	w/Wear Sensor	HB190x.730A	D227	HB271x.635	D228
80		2.3	1991-1992		HB190x.730	D227	HB271x.635	D228
80		2.3	1991-1992	w/Wear Sensor	HB190x.730A	D227	HB271x.635	D228
90	CS	2.8	1993-1993		HB270x.724	D419	HB271x.635	D228
90	CS	2.8	1993-1993	w/Wear Sensor	HB270x.724A	D419	HB271x.635	D228
90	CS	2.8	1994-1994		HB270x.724	D419	HB271x.635	D228
90	CS	2.8	1994-1994	w/Wear Sensor	HB270x.724A	D419	HB271x.635	D228
90	S	2.8	1993-1993	w/Wear Sensor	HB270x.724A	D419	HB271x.635	D228
90	S	2.8	1993-1994		HB270x.724	D419	HB271x.635	D228
90	S	2.8	1994-1994	w/Wear Sensor	HB270x.724A	D419	HB271x.635	D228
90	Sport	2.8	1995-1995		HB270x.724	D419	HB271x.635	D228
90	Sport	2.8	1995-1995	w/Wear Sensor	HB270x.724A	D419	HB271x.635	D228
90		2.0	1988-1988		HB190x.730	D227	HB271x.635	D228
90		2.0	1988-1988	w/Wear Sensor	HB190x.730A	D227	HB271x.635	D228
90		2.3	1988-1991		HB190x.730	D227	HB271x.635	D228
90		2.3	1988-1991	w/Wear Sensor	HB190x.730A	D227	HB271x.635	D228
100	CS	2.8	1992-1994		HB269x.763	D555	HB271x.635	D228
100	CS	2.8	1992-1994	w/Oval Wear Sensor	HB269x.763A	D555	HB271x.635	D228
100	CS	2.8	1992-1994	w/Large Round Wear Sensor	HB269x.763B	D555	HB271x.635	D228
100	S	2.8	1992-1994		HB269x.763	D555	HB271x.635	D228
100	S	2.8	1992-1994	w/Oval Wear Sensor	HB269x.763A	D555	HB271x.635	D228
100	S	2.8	1992-1994	w/Large Round Wear Sensor	HB269x.763B	D555	HB271x.635	D228
100		2.8	1992-1993		HB269x.763	D555	HB271x.635	D228
100		2.8	1992-1993	w/Oval Wear Sensor	HB269x.763A	D555	HB271x.635	D228
100		2.8	1992-1993	w/Large Round Wear Sensor	HB269x.763B	D555	HB271x.635	D228
200		2.2	1989-1991	w/ATE Front Caliper	HB135x.642	D394	HB271x.635	D228
200		2.2	1989-1991	w/Girling Front Caliper	HB270x.724	D419	HB271x.635	D228
200		2.2	1989-1991	w/Girling Front Caliper, w/Wear Sensor	HB270x.724A	D419	HB271x.635	D228
5000	CS	2.2	1986-1987		HB270x.724	D419	HB271x.635	D228
5000	CS	2.2	1986-1987	w/Wear Sensor	HB270x.724A	D419	HB271x.635	D228
5000	S	2.0	1980-1981		HB190x.730	D227	HB271x.635	D228
5000	S	2.0	1980-1981	w/Wear Sensor	HB190x.730A	D227	HB271x.635	D228
5000	S	2.2	1980-1983		HB190x.730	D227	HB271x.635	D228
5000	S	2.2	1980-1983	w/Wear Sensor	HB190x.730A	D227	HB271x.635	D228
5000	S	2.2	1984-1984		HB190x.600	D227	HB271x.635	D228
5000	S	2.2	1984-1984	w/Wear Sensor	HB190x.600A	D227	HB271x.635	D228
5000	S	2.2	1985-1987		HB190x.730	D227	HB271x.635	D228
5000	S	2.2	1985-1987	w/Wear Sensor	HB190x.730A	D227	HB271x.635	D228
5000	S	2.3	1987-1987		HB190x.730	D227	HB271x.635	D228
5000	S	2.3	1987-1987	w/Wear Sensor	HB190x.730A	D227	HB271x.635	D228
5000	S	2.3	1988-1988		HB270x.724	D419	HB271x.635	D228
5000	S	2.3	1988-1988	w/Wear Sensor	HB270x.724A	D419	HB271x.635	D228
5000	S Turbo	2.2	1984-1985		HB190x.600	D227	HB271x.635	D228
5000	S Turbo	2.2	1984-1985	w/Wear Sensor	HB190x.600A	D227	HB271x.635	D228

RACE COMPOUND CODES

DTC-70 - U	DTC-05 - H	MT-4 - L	DR-97 - J
DTC-60 - G	HT-14 - V	Blue 9012 - E	HP Plus - N
DTC-30 - W	HT-10 - S	Black - M	

STREET COMPOUND CODES

HPS Performance Street - F	SuperDuty - P
Performance Ceramic - Z	
LTS Light Truck & SUV - Y	

Make/Model	Submodel	Engine (Liter)	Years	Note	FRONT		REAR	
					Hawk #	FMSI	Hawk #	FMSI
AUDI CONT.								
5000	Turbo	2.2	1981-1983		HB190x.730	D227	HB271x.635	D228
5000	Turbo	2.2	1981-1983	w/Wear Sensor	HB190x.730A	D227	HB271x.635	D228
5000		2.0	1980-1983		HB190x.730	D227	HB271x.635	D228
5000		2.0	1980-1983	w/Wear Sensor	HB190x.730A	D227	HB271x.635	D228
5000		2.2	1980-1983		HB190x.730	D227	HB271x.635	D228
5000		2.2	1980-1983	w/Wear Sensor	HB190x.730A	D227	HB271x.635	D228
5000		2.2	1982-1982		HB190x.600	D227	HB271x.635	D228
5000		2.2	1982-1982	w/Wear Sensor	HB190x.600A	D227	HB271x.635	D228
100 Quattro	CS	2.8	1992-1994		HB269x.763	D555	HB271x.635	D228
100 Quattro	CS	2.8	1992-1994	w/Oval Wear Sensor	HB269x.763A	D555	HB271x.635	D228
100 Quattro	CS	2.8	1992-1994	w/Large Round Wear Sensor	HB269x.763B	D555	HB271x.635	D228
200 Quattro	10V	2.2	1991-1991	w/ATE Front Caliper	HB135x.642	D394	HB271x.635	D228
200 Quattro	10V	2.2	1991-1991	w/Girling Front Caliper	HB270x.724	D419	HB271x.635	D228
200 Quattro	10V	2.2	1991-1991	w/Girling Front Caliper, w/Wear Sensor	HB270x.724A	D419	HB271x.635	D228
200 Quattro	20V	2.2	1991-1991	w/ATE Front Caliper	HB135x.642	D394	HB271x.635	D228
200 Quattro	20V	2.2	1991-1991	w/Girling Front Caliper	HB270x.724	D419	HB271x.635	D228
200 Quattro	20V	2.2	1991-1991	w/Girling Front Caliper, w/Wear Sensor	HB270x.724A	D419	HB271x.635	D228
200 Quattro		2.2	1989-1990	w/ATE Front Caliper	HB135x.642	D394	HB271x.635	D228
200 Quattro		2.2	1989-1990	w/Girling Front Caliper	HB270x.724	D419	HB271x.635	D228
200 Quattro		2.2	1989-1990	w/Girling Front Caliper, w/Wear Sensor	HB270x.724A	D419	HB271x.635	D228
4000CS Quattro		2.2	1986-1987		HB190x.600	D227	HB271x.635	D228
4000CS Quattro		2.2	1986-1987	w/Wear Sensor	HB190x.600A	D227	HB271x.635	D228
4000S Quattro		2.2	1984-1985		HB190x.600	D227	HB271x.635	D228
4000S Quattro		2.2	1984-1985	w/Wear Sensor	HB190x.600A	D227	HB271x.635	D228
5000CS Quattro		2.2	1986-1986		HB190x.730	D227	HB271x.635	D228
5000CS Quattro		2.2	1986-1986	w/Wear Sensor	HB190x.730A	D227	HB271x.635	D228
5000CS Quattro		2.2	1987-1988		HB270x.724	D419	HB271x.635	D228
5000CS Quattro		2.2	1987-1988	w/Wear Sensor	HB270x.724A	D419	HB271x.635	D228
80 Quattro		2.3	1988-1992		HB190x.730	D227	HB271x.635	D228
80 Quattro		2.3	1988-1992	w/Wear Sensor	HB190x.730A	D227	HB271x.635	D228
90 Quattro	20V	2.3	1990-1991		HB190x.730	D227	HB271x.635	D228
90 Quattro	20V	2.3	1990-1991	w/Wear Sensor	HB190x.730A	D227	HB271x.635	D228
90 Quattro	CS	2.8	1993-1994		HB270x.724	D419	HB271x.635	D228
90 Quattro	CS	2.8	1993-1994	w/Wear Sensor	HB270x.724A	D419	HB271x.635	D228
90 Quattro	Sport	2.8	1995-1995		HB270x.724	D419	HB271x.635	D228
90 Quattro	Sport	2.8	1995-1995	w/Wear Sensor	HB270x.724A	D419	HB271x.635	D228
90 Quattro		2.3	1988-1989		HB190x.730	D227	HB271x.635	D228
90 Quattro		2.3	1988-1989	w/Wear Sensor	HB190x.730A	D227	HB271x.635	D228
90 Quattro		2.8	1995-1995		HB270x.724	D419	HB271x.635	D228
90 Quattro		2.8	1995-1995	w/Wear Sensor	HB270x.724A	D419	HB271x.635	D228
A3	Quattro	3.2	2006-2007		HB543x.760	D1107	HB544x.628	D1108
A3		2.0	2006-2008		HB543x.760	D1107	HB544x.628	D1108
A4	Avant	2.8	1998-1998		HB269x.763	D555	HB271x.635	D228
A4	Avant	2.8	1998-1998	w/Oval Wear Sensor	HB269x.763A	D555	HB271x.635	D228
A4	Avant	2.8	1998-1998	w/Large Round Wear Sensor	HB269x.763B	D555	HB271x.635	D228
A4	Cabriolet	1.8	2003-2004		HB354x.756	D840	HB364x.642	D340
A4	Cabriolet	1.8	2003-2004	w/Wear Sensor	HB354x.756A	D840	HB364x.642	D340
A4	Cabriolet	3.0	2003-2004		HB354x.756	D840	HB364x.642	D340
A4	Cabriolet	3.0	2003-2004	w/Wear Sensor	HB354x.756A	D840	HB364x.642	D340
A4		1.8	1997-1999		HB269x.763	D555	HB271x.635	D228
A4		1.8	1997-1999	w/Oval Wear Sensor	HB269x.763A	D555	HB271x.635	D228
A4		1.8	1997-1999	w/Large Round Wear Sensor	HB269x.763B	D555	HB271x.635	D228

CODE Breakdown

HB 245 x .631

Insert Compound Code

Make/Model	Submodel	Engine (Liter)	Years	Note	FRONT		REAR	
					Hawk #	FMSI	Hawk #	FMSI
AUDI CONT.								
A4		1.8	2000-2001		HB269x.763	D555	HB364x.642	D340
A4		1.8	2000-2001	w/Oval Wear Sensor	HB269x.763A	D555	HB364x.642	D340
A4		1.8	2000-2001	w/Large Round Wear Sensor	HB269x.763B	D555	HB364x.642	D340
A4		1.8	2002-2004		HB354x.756	D840	HB364x.642	D340
A4		1.8	2002-2004	w/Wear Sensor	HB354x.756A	D840	HB364x.642	D340
A4		1.8	2005-2005		HB538x.760	D1111	HB544x.628	D1108
A4		2.0	2005-2008		HB538x.760	D1111	HB544x.628	D1108
A4		2.8	1996-1999		HB269x.763	D555	HB271x.635	D228
A4		2.8	1996-1999	w/Oval Wear Sensor	HB269x.763A	D555	HB271x.635	D228
A4		2.8	1996-1999	w/Large Round Wear Sensor	HB269x.763B	D555	HB271x.635	D228
A4		2.8	2000-2001		HB269x.763	D555	HB364x.642	D340
A4		2.8	2000-2001	w/Oval Wear Sensor	HB269x.763A	D555	HB364x.642	D340
A4		2.8	2000-2001	w/Large Round Wear Sensor	HB269x.763B	D555	HB364x.642	D340
A4		3.0	2002-2004		HB354x.756	D840	HB364x.642	D340
A4		3.0	2002-2004	w/Wear Sensor	HB354x.756A	D840	HB364x.642	D340
A4		3.0	2005-2005		HB538x.760	D1111	HB544x.628	D1108
A4		3.2	2006-2007		HB538x.760	D1111	HB544x.628	D1108
A4 Quattro	Avant	1.8	1999-1999		HB269x.763	D555	HB271x.635	D228
A4 Quattro	Avant	1.8	1999-1999	w/Oval Wear Sensor	HB269x.763A	D555	HB271x.635	D228
A4 Quattro	Avant	1.8	1999-1999	w/Large Round Wear Sensor	HB269x.763B	D555	HB271x.635	D228
A4 Quattro	Avant	1.8	2000-2002		HB269x.763	D555		
A4 Quattro	Avant	1.8	2000-2002	w/Oval Wear Sensor	HB269x.763A	D555		
A4 Quattro	Avant	1.8	2000-2002	w/Large Round Wear Sensor	HB269x.763B	D555		
A4 Quattro	Avant	1.8	2003-2004		HB354x.756	D840		
A4 Quattro	Avant	1.8	2003-2004	w/Wear Sensor	HB354x.756A	D840		
A4 Quattro	Avant	1.8	2005-2005		HB538x.760	D1111	HB544x.628	D1108
A4 Quattro	Avant	2.0	2005-2008		HB538x.760	D1111	HB544x.628	D1108
A4 Quattro	Avant	2.8	1998-1999		HB269x.763	D555	HB271x.635	D228
A4 Quattro	Avant	2.8	1998-1999	w/Oval Wear Sensor	HB269x.763A	D555	HB271x.635	D228
A4 Quattro	Avant	2.8	1998-1999	w/Large Round Wear Sensor	HB269x.763B	D555	HB271x.635	D228
A4 Quattro	Avant	2.8	2000-2001		HB269x.763	D555		
A4 Quattro	Avant	2.8	2000-2001	w/Oval Wear Sensor	HB269x.763A	D555		
A4 Quattro	Avant	2.8	2000-2001	w/Large Round Wear Sensor	HB269x.763B	D555		
A4 Quattro	Avant	3.0	2002-2002		HB269x.763	D555		
A4 Quattro	Avant	3.0	2002-2002	w/Oval Wear Sensor	HB269x.763A	D555		
A4 Quattro	Avant	3.0	2002-2002	w/Large Round Wear Sensor	HB269x.763B	D555		
A4 Quattro	Avant	3.0	2003-2004		HB354x.756	D840		
A4 Quattro	Avant	3.0	2003-2004	w/Wear Sensor	HB354x.756A	D840		
A4 Quattro	Avant	3.0	2005-2005		HB538x.760	D1111	HB544x.628	D1108
A4 Quattro	Avant	3.2	2005-2008		HB538x.760	D1111	HB544x.628	D1108
A4 Quattro	Cabriolet	1.8	2004-2004		HB354x.756	D840		
A4 Quattro	Cabriolet	1.8	2004-2004	w/Wear Sensor	HB354x.756A	D840		
A4 Quattro	Cabriolet	2.0	2007-2007		HB538x.760	D1111		
A4 Quattro	Cabriolet	2.0	2008-2008		HB538x.760	D1111	HB544x.628	D1108
A4 Quattro	Cabriolet	3.0	2004-2004		HB354x.756	D840		
A4 Quattro	Cabriolet	3.0	2004-2004	w/Wear Sensor	HB354x.756A	D840		
A4 Quattro	Cabriolet	3.0	2005-2006		HB538x.760	D1111	HB544x.628	D1108
A4 Quattro	Cabriolet	3.2	2007-2007		HB538x.760	D1111		
A4 Quattro	Cabriolet	3.2	2008-2008		HB538x.760	D1111	HB544x.628	D1108
A4 Quattro		1.8	1997-2002		HB269x.763	D555		
A4 Quattro		1.8	1997-2002	w/Oval Wear Sensor	HB269x.763A	D555		
A4 Quattro		1.8	1997-2002	w/Large Round Wear Sensor	HB269x.763B	D555		

RACE COMPOUND CODES

DTC-70 - U	DTC-05 - H	MT-4 - L	DR-97 - J
DTC-60 - G	HT-14 - V	Blue 9012 - E	HP Plus - N
DTC-30 - W	HT-10 - S	Black - M	

STREET COMPOUND CODES

HPS Performance Street - F	SuperDuty - P
Performance Ceramic - Z	
LTS Light Truck & SUV - Y	

Make/Model	Submodel	Engine (Liter)	Years	Note	FRONT		REAR	
					Hawk #	FMSI	Hawk #	FMSI
AUDI CONT.								
A4 Quattro		1.8	2003-2004		HB354x.756	D840		
A4 Quattro		1.8	2003-2004	w/Wear Sensor	HB354x.756A	D840		
A4 Quattro		1.8	2005-2005		HB538x.760	D1111	HB544x.628	D1108
A4 Quattro		2.0	2005-2008		HB538x.760	D1111	HB544x.628	D1108
A4 Quattro		2.8	1996-2001		HB269x.763	D555		
A4 Quattro		2.8	1996-2001	w/Oval Wear Sensor	HB269x.763A	D555		
A4 Quattro		2.8	1996-2001	w/Large Round Wear Sensor	HB269x.763B	D555		
A4 Quattro		3.0	2002-2002		HB269x.763	D555		
A4 Quattro		3.0	2002-2002	w/Oval Wear Sensor	HB269x.763A	D555		
A4 Quattro		3.0	2002-2002	w/Large Round Wear Sensor	HB269x.763B	D555		
A4 Quattro		3.0	2003-2004		HB354x.756	D840		
A4 Quattro		3.0	2003-2004	w/Wear Sensor	HB354x.756A	D840		
A4 Quattro		3.0	2005-2005		HB538x.760	D1111	HB544x.628	D1108
A4 Quattro		3.2	2005-2008		HB538x.760	D1111	HB544x.628	D1108
A6		2.8	1995-1998		HB269x.763	D555	HB271x.635	D228
A6		2.8	1995-1998	w/Oval Wear Sensor	HB269x.763A	D555	HB271x.635	D228
A6		2.8	1995-1998	w/Large Round Wear Sensor	HB269x.763B	D555	HB271x.635	D228
A6		2.8	1999-1999		HB269x.763	D555		
A6		2.8	1999-1999	w/Oval Wear Sensor	HB269x.763A	D555		
A6		2.8	1999-1999	w/Large Round Wear Sensor	HB269x.763B	D555		
A6		2.8	2000-2001		HB269x.763	D555	HB364x.642	D340
A6		2.8	2000-2001	w/Oval Wear Sensor	HB269x.763A	D555	HB364x.642	D340
A6		2.8	2000-2001	w/Large Round Wear Sensor	HB269x.763B	D555	HB364x.642	D340
A6		3.0	2002-2003		HB354x.756	D840	HB364x.642	D340
A6		3.0	2002-2003	w/Wear Sensor	HB354x.756A	D840	HB364x.642	D340
A6		3.0	2004-2004		HB354x.756	D840		
A6		3.0	2004-2004	w/Wear Sensor	HB354x.756A	D840		
A6		3.2	2006-2007		HB538x.760	D1111	HB544x.628	D1108
A6		3.2	2008-2008		HB538x.760	D1111		
A6 Quattro	Avant	2.8	1999-1999		HB269x.763	D555		
A6 Quattro	Avant	2.8	1999-1999	w/Oval Wear Sensor	HB269x.763A	D555		
A6 Quattro	Avant	2.8	1999-1999	w/Large Round Wear Sensor	HB269x.763B	D555		
A6 Quattro	Avant	2.8	2000-2001		HB363x.689	D912	HB364x.642	D340
A6 Quattro	Avant	2.8	2000-2001	w/Oval Wear Sensor	HB363x.689A	D912	HB364x.642	D340
A6 Quattro	Avant	2.8	2000-2001	w/Large Round Wear Sensor	HB363x.689B	D912	HB364x.642	D340
A6 Quattro	Avant	3.0	2002-2003		HB515x.760	D915	HB364x.642	D340
A6 Quattro	Avant	3.0	2004-2004	w/Dual Piston	HB363x.689	D912	HB364x.642	D340
A6 Quattro	Avant	3.0	2004-2004	w/Dual Piston, w/Oval Wear Sensor	HB363x.689A	D912	HB364x.642	D340
A6 Quattro	Avant	3.0	2004-2004	w/Dual Piston, w/Large Round Wear Sensor	HB363x.689B	D912	HB364x.642	D340
A6 Quattro	Avant	3.0	2004-2004	w/Single Piston	HB515x.760	D915	HB364x.642	D340
A6 Quattro	Avant	3.2	2006-2006		HB538x.760	D1111	HB544x.628	D1108
A6 Quattro	Avant	3.2	2007-2008		HB538x.760	D1111		
A6 Quattro		2.7	2000-2001		HB363x.689	D912		
A6 Quattro		2.7	2000-2001	w/Oval Wear Sensor	HB363x.689A	D912		
A6 Quattro		2.7	2000-2001	w/Large Round Wear Sensor	HB363x.689B	D912		
A6 Quattro		2.7	2002-2002	w/Dual Piston	HB363x.689	D912	HB364x.642	D340
A6 Quattro		2.7	2002-2002	w/Dual Piston, w/Oval Wear Sensor	HB363x.689A	D912	HB364x.642	D340
A6 Quattro		2.7	2002-2002	w/Dual Piston, w/Large Round Wear Sensor	HB363x.689B	D912	HB364x.642	D340
A6 Quattro		2.7	2002-2002	w/Single Piston	HB515x.760	D915	HB364x.642	D340
A6 Quattro		2.7	2003-2003		HB363x.689	D912	HB364x.642	D340
A6 Quattro		2.7	2003-2003	w/Oval Wear Sensor	HB363x.689A	D912	HB364x.642	D340
A6 Quattro		2.7	2003-2003	w/Large Round Wear Sensor	HB363x.689B	D912	HB364x.642	D340

CODE Breakdown

HB 245 x .631

Insert Compound Code

Make/Model	Submodel	Engine (Liter)	Years	Note	FRONT		REAR	
					Hawk #	FMSI	Hawk #	FMSI
AUDI CONT.								
A6 Quattro		2.7	2004-2004	w/Dual Piston	HB363x.689	D912	HB364x.642	D340
A6 Quattro		2.7	2004-2004	w/Dual Piston, w/Oval Wear Sensor	HB363x.689A	D912	HB364x.642	D340
A6 Quattro		2.7	2004-2004	w/Dual Piston, w/Large Round Wear Sensor	HB363x.689B	D912	HB364x.642	D340
A6 Quattro		2.7	2004-2004	w/Single Piston	HB515x.760	D915	HB364x.642	D340
A6 Quattro		2.8	1995-1996		HB269x.763	D555		
A6 Quattro		2.8	1995-1996	w/Oval Wear Sensor	HB269x.763A	D555		
A6 Quattro		2.8	1995-1996	w/Large Round Wear Sensor	HB269x.763B	D555		
A6 Quattro		2.8	1997-1998		HB269x.763	D555	HB271x.635	D228
A6 Quattro		2.8	1997-1998	w/Oval Wear Sensor	HB269x.763A	D555	HB271x.635	D228
A6 Quattro		2.8	1997-1998	w/Large Round Wear Sensor	HB269x.763B	D555	HB271x.635	D228
A6 Quattro		2.8	1999-1999		HB269x.763	D555		
A6 Quattro		2.8	1999-1999	w/Oval Wear Sensor	HB269x.763A	D555		
A6 Quattro		2.8	1999-1999	w/Large Round Wear Sensor	HB269x.763B	D555		
A6 Quattro		2.8	2000-2001		HB363x.689	D912	HB364x.642	D340
A6 Quattro		2.8	2000-2001	w/Oval Wear Sensor	HB363x.689A	D912	HB364x.642	D340
A6 Quattro		2.8	2000-2001	w/Large Round Wear Sensor	HB363x.689B	D912	HB364x.642	D340
A6 Quattro		3.0	2002-2002	w/Dual Piston	HB363x.689	D912	HB364x.642	D340
A6 Quattro		3.0	2002-2002	w/Dual Piston, w/Oval Wear Sensor	HB363x.689A	D912	HB364x.642	D340
A6 Quattro		3.0	2002-2002	w/Dual Piston, w/Large Round Wear Sensor	HB363x.689B	D912	HB364x.642	D340
A6 Quattro		3.0	2002-2002	w/Single Piston	HB515x.760	D915	HB364x.642	D340
A6 Quattro		3.0	2004-2004	w/Dual Piston	HB363x.689	D912	HB364x.642	D340
A6 Quattro		3.0	2004-2004	w/Dual Piston, w/Oval Wear Sensor	HB363x.689A	D912	HB364x.642	D340
A6 Quattro		3.0	2004-2004	w/Dual Piston, w/Large Round Wear Sensor	HB363x.689B	D912	HB364x.642	D340
A6 Quattro		3.0	2004-2004	w/Single Piston	HB515x.760	D915	HB364x.642	D340
A6 Quattro		3.2	2006-2007		HB538x.760	D1111	HB544x.628	D1108
A6 Quattro		3.2	2008-2008		HB538x.760	D1111	HB544x.628	D1108
A6 Quattro		4.2	2000-2001		HB363x.689	D912	HB364x.642	D340
A6 Quattro		4.2	2000-2001	w/Oval Wear Sensor	HB363x.689A	D912	HB364x.642	D340
A6 Quattro		4.2	2000-2001	w/Large Round Wear Sensor	HB363x.689B	D912	HB364x.642	D340
A6 Quattro		4.2	2002-2002	w/Dual Piston	HB363x.689	D912	HB364x.642	D340
A6 Quattro		4.2	2002-2002	w/Dual Piston, w/Oval Wear Sensor	HB363x.689A	D912	HB364x.642	D340
A6 Quattro		4.2	2002-2002	w/Dual Piston, w/Large Round Wear Sensor	HB363x.689B	D912	HB364x.642	D340
A6 Quattro		4.2	2002-2002	w/Single Piston	HB515x.760	D915	HB364x.642	D340
A6 Quattro		4.2	2003-2003		HB363x.689	D912	HB364x.642	D340
A6 Quattro		4.2	2003-2003	w/Oval Wear Sensor	HB363x.689A	D912	HB364x.642	D340
A6 Quattro		4.2	2003-2003	w/Large Round Wear Sensor	HB363x.689B	D912	HB364x.642	D340
A6 Quattro		4.2	2004-2004	w/Dual Piston	HB363x.689	D912	HB364x.642	D340
A6 Quattro		4.2	2004-2004	w/Dual Piston, w/Oval Wear Sensor	HB363x.689A	D912	HB364x.642	D340
A6 Quattro		4.2	2004-2004	w/Dual Piston, w/Large Round Wear Sensor	HB363x.689B	D912	HB364x.642	D340
A6 Quattro		4.2	2004-2004	w/Single Piston	HB515x.760	D915	HB364x.642	D340
A6 Quattro		4.2	2006-2007		HB538x.760	D1111	HB553x.652	D1018
A8		3.7	1997-1998		HB269x.763	D555	HB271x.635	D228
A8		3.7	1997-1998	w/Oval Wear Sensor	HB269x.763A	D555	HB271x.635	D228
A8		3.7	1997-1998	w/Large Round Wear Sensor	HB269x.763B	D555	HB271x.635	D228
A8		3.7	1999-1999		HB269x.763	D555		
A8		3.7	1999-1999	w/Oval Wear Sensor	HB269x.763A	D555		
A8		3.7	1999-1999	w/Large Round Wear Sensor	HB269x.763B	D555		
A8 Quattro	L	4.2	2001-2003		HB363x.689	D912	HB364x.642	D340
A8 Quattro	L	4.2	2001-2003	w/Oval Wear Sensor	HB363x.689A	D912	HB364x.642	D340
A8 Quattro	L	4.2	2001-2003	w/Large Round Wear Sensor	HB363x.689B	D912	HB364x.642	D340
A8 Quattro	L	4.2	2008-2008		HB533x.668	D1078	HB553x.652	D1018
A8 Quattro	L	6.0	2008-2008		HB533x.668	D1078	HB553x.652	D1018

RACE COMPOUND CODES

DTC-70 - U	DTC-05 - H	MT-4 - L	DR-97 - J
DTC-60 - G	HT-14 - V	Blue 9012 - E	HP Plus - N
DTC-30 - W	HT-10 - S	Black - M	

STREET COMPOUND CODES

HPS Performance Street - F	SuperDuty - P
Performance Ceramic - Z	
LTS Light Truck & SUV - Y	

Make/Model	Submodel	Engine (Liter)	Years	Note	FRONT		REAR	
					Hawk #	FMSI	Hawk #	FMSI
AUDI CONT.								
A8 Quattro		4.2	1997-1999		HB269x.763	D555	HB271x.635	D228
A8 Quattro		4.2	1997-1999	w/Oval Wear Sensor	HB269x.763A	D555	HB271x.635	D228
A8 Quattro		4.2	1997-1999	w/Large Round Wear Sensor	HB269x.763B	D555	HB271x.635	D228
A8 Quattro		4.2	2000-2003		HB363x.689	D912	HB364x.642	D340
A8 Quattro		4.2	2000-2003	w/Oval Wear Sensor	HB363x.689A	D912	HB364x.642	D340
A8 Quattro		4.2	2000-2003	w/Large Round Wear Sensor	HB363x.689B	D912	HB364x.642	D340
A8 Quattro		4.2	2001-2003	w/Wear Sensor	HB184x.650A	D594		
A8 Quattro		4.2	2001-2003	w/Wear Sensor	HB184x.650B	D594		
A8 Quattro		4.2	2001-2003	w/Wear Sensor	HB184x.650C	D594		
A8 Quattro		4.2	2008-2008		HB533x.668	D1078	HB553x.652	D1018
AllRoad Quattro		2.7	2001-2002		HB363x.689	D912	HB364x.642	D340
AllRoad Quattro		2.7	2001-2002	w/Oval Wear Sensor	HB363x.689A	D912	HB364x.642	D340
AllRoad Quattro		2.7	2001-2002	w/Large Round Wear Sensor	HB363x.689B	D912	HB364x.642	D340
AllRoad Quattro		2.7	2003-2005	w/Dual Piston	HB363x.689	D912	HB364x.642	D340
AllRoad Quattro		2.7	2003-2005	w/Dual Piston, w/Oval Wear Sensor	HB363x.689A	D912	HB364x.642	D340
AllRoad Quattro		2.7	2003-2005	w/Dual Piston, w/Large Round Wear Sensor	HB363x.689B	D912	HB364x.642	D340
AllRoad Quattro		2.7	2003-2005	w/Single Piston	HB515x.760	D915	HB364x.642	D340
AllRoad Quattro		4.2	2003-2003		HB363x.689	D912	HB364x.642	D340
AllRoad Quattro		4.2	2003-2003	w/Oval Wear Sensor	HB363x.689A	D912	HB364x.642	D340
AllRoad Quattro		4.2	2003-2003	w/Large Round Wear Sensor	HB363x.689B	D912	HB364x.642	D340
AllRoad Quattro		4.2	2004-2005	w/Dual Piston	HB363x.689	D912	HB364x.642	D340
AllRoad Quattro		4.2	2004-2005	w/Dual Piston, w/Oval Wear Sensor	HB363x.689A	D912	HB364x.642	D340
AllRoad Quattro		4.2	2004-2005	w/Dual Piston, w/Large Round Wear Sensor	HB363x.689B	D912	HB364x.642	D340
AllRoad Quattro		4.2	2004-2005	w/Single Piston	HB515x.760	D915	HB364x.642	D340
Cabriolet		2.8	1994-1997		HB270x.724	D419	HB271x.635	D228
Cabriolet		2.8	1994-1997	w/Wear Sensor	HB270x.724A	D419	HB271x.635	D228
Coupe	GT	2.2	1985-1987		HB190x.600	D227		
Coupe	GT	2.2	1985-1987	w/Wear Sensor	HB190x.600A	D227		
Coupe	GT	2.3	1987-1987		HB190x.600	D227		
Coupe	GT	2.3	1987-1987	w/Wear Sensor	HB190x.600A	D227		
Coupe Quattro	20V	2.3	1990-1991		HB270x.724	D419	HB271x.635	D228
Coupe Quattro	20V	2.3	1990-1991	w/Wear Sensor	HB270x.724A	D419	HB271x.635	D228
Q7	Premium	3.6	2007-2008		HB501x.625	D1014	HB502x.606	D978
Q7	Premium	4.2	2007-2008		HB501x.625	D1014	HB502x.606	D978
Q7		3.6	2007-2008		HB501x.625	D1014	HB502x.606	D978
Q7		4.2	2007-2007		HB501x.625	D1014	HB502x.606	D978
S4	Avant	2.7	2001-2001		HB363x.689	D912		
S4	Avant	2.7	2001-2001	w/Oval Wear Sensor	HB363x.689A	D912		
S4	Avant	2.7	2001-2001	w/Large Round Wear Sensor	HB363x.689B	D912		
S4	Avant	2.7	2002-2002		HB363x.689	D912	HB364x.642	D340
S4	Avant	2.7	2002-2002	w/Oval Wear Sensor	HB363x.689A	D912	HB364x.642	D340
S4	Avant	2.7	2002-2002	w/Large Round Wear Sensor	HB363x.689B	D912	HB364x.642	D340
S4	Avant	4.2	2004-2008		HB538x.760	D1111	HB553x.652	D1018
S4	Cabriolet	4.2	2004-2008		HB538x.760	D1111	HB553x.652	D1018
S4		2.2	1993-1994		HB270x.724	D419	HB271x.635	D228
S4		2.2	1993-1994	w/Wear Sensor	HB270x.724A	D419	HB271x.635	D228
S4		2.7	2000-2002		HB363x.689	D912	HB364x.642	D340
S4		2.7	2000-2002	w/Oval Wear Sensor	HB363x.689A	D912	HB364x.642	D340
S4		2.7	2000-2002	w/Large Round Wear Sensor	HB363x.689B	D912	HB364x.642	D340
S4		2.7	2003-2003		HB354x.756	D840	HB364x.642	D340
S4		4.2	2004-2008		HB538x.760	D1111	HB553x.652	D1018
S6	Avant	4.2	2002-2002		HB363x.689	D912	HB364x.642	D340

CODE Breakdown

HB 245 x .631

Insert Compound Code

Make/Model	Submodel	Engine (Liter)	Years	Note	FRONT		REAR	
					Hawk #	FMSI	Hawk #	FMSI
AUDI CONT.								
S6	Avant	4.2	2002-2002	w/Oval Wear Sensor	HB363x.689A	D912	HB364x.642	D340
S6	Avant	4.2	2002-2002	w/Large Round Wear Sensor	HB363x.689B	D912	HB364x.642	D340
S6	Avant	4.2	2003-2003		HB363x.689	D912		
S6	Avant	4.2	2003-2003	w/Oval Wear Sensor	HB363x.689A	D912		
S6	Avant	4.2	2003-2003	w/Large Round Wear Sensor	HB363x.689B	D912		
S6		2.2	1995-1995		HB270x.724	D419	HB271x.635	D228
S6		2.2	1995-1995	w/Wear Sensor	HB270x.724A	D419	HB271x.635	D228
S8		4.2	2001-2003	w/Wear Sensor	HB184x.650A	D594	HB364x.642	D340
S8		4.2	2001-2003	w/Wear Sensor	HB184x.650B	D594	HB364x.642	D340
S8		4.2	2001-2003	w/Wear Sensor	HB184x.650C	D594	HB364x.642	D340
S8		4.2	2001-2003		HB363x.689	D912	HB364x.642	D340
S8		4.2	2001-2003	w/Oval Wear Sensor	HB363x.689A	D912	HB364x.642	D340
S8		4.2	2001-2003	w/Large Round Wear Sensor	HB363x.689B	D912	HB364x.642	D340
Super 90		1.8	1970-1972		HB172x.595	D31		
TT		1.8	2000-2006		HB272x.763	D687		
TT		1.8	2000-2006	w/Wear Sensor	HB272x.763A	D687		
TT Quattro		1.8	2000-2003		HB272x.763	D687	HB364x.642	D340
TT Quattro		1.8	2000-2003	w/Wear Sensor	HB272x.763A	D687	HB364x.642	D340
TT Quattro		1.8	2004-2004		HB497x.776	D682	HB364x.642	D340
TT Quattro		1.8	2005-2006		HB272x.763	D687	HB364x.642	D340
TT Quattro		1.8	2005-2006	w/Wear Sensor	HB272x.763A	D687	HB364x.642	D340
TT Quattro		3.2	2004-2004		HB272x.763	D687	HB364x.642	D340
TT Quattro		3.2	2004-2004	w/Wear Sensor	HB272x.763A	D687	HB364x.642	D340
TT Quattro		3.2	2005-2006		HB497x.776	D682	HB364x.642	D340
V8 Quattro	32V	3.6	1990-1991		HB270x.724	D419		
V8 Quattro	32V	3.6	1990-1991	w/Wear Sensor	HB270x.724A	D419		
V8 Quattro	32V	4.2	1992-1992		HB270x.724	D419		
V8 Quattro	32V	4.2	1992-1992	w/Wear Sensor	HB270x.724A	D419		
BMW								
128i		3.0	2008-2008		HB534x.750	D1061		
135i		3.0	2008-2008		HB603x.616	D1371	HB604x.598	D1372
325		2.7	1986-1988		HB195x.640	D278	HB399x.630	D279
2000	Touring	2.0	1971-1971		HB206x.565	D163		
2000		2.0	1969-1971		HB206x.565	D163		
2002		2.0	1969-1971		HB206x.565	D163		
2500		2.5	1969-1971		HB206x.565	D163		
2800		2.8	1969-1971		HB206x.565	D163		
2000c		2.0	1969-1970		HB206x.565	D163		
2000cs		2.0	1969-1970		HB206x.565	D163		
2000Ti		2.0	1969-1971		HB206x.565	D163		
2000Tii	Lux	2.0	1969-1971		HB206x.565	D163		
2000Tii	Touring	2.0	1971-1971		HB206x.565	D163		
2000Tii		2.0	1969-1971		HB206x.565	D163		
2002Ti		2.0	1969-1971		HB206x.565	D163		
2002Tii		2.0	1971-1974		HB206x.565	D163		
3.0cs		3.0	1972-1974		HB206x.565	D163		
3.0csi		3.0	1971-1974		HB206x.565	D163		
3.0csi		3.0	1971-1971		HB206x.565	D163		
3.0s		3.0	1971-1974		HB206x.565	D163		
3.0si		3.0	1971-1971		HB206x.565	D163		
3.0si		3.0	1975-1976		HB206x.565	D163		
318i		1.8	1984-1985		HB195x.640	D278		

RACE COMPOUND CODES

DTC-70 - U | DTC-05 - H | MT-4 - L | DR-97 - J
 DTC-60 - G | HT-14 - V | Blue 9012 - E | HP Plus - N
 DTC-30 - W | HT-10 - S | Black - M

STREET COMPOUND CODES

HPS Performance Street - F | SuperDuty - P
 Performance Ceramic - Z
 LTS Light Truck & SUV - Y

Make/ Model	Submodel	Engine (Liter)	Years	Note	FRONT		REAR	
					Hawk #	FMSI	Hawk #	FMSI
BMW CONT.								
318i		1.8	1991-1991		HB195x.640	D278	HB399x.630	D279
318i		1.8	1992-1995		HB136x.690	D558	HB227x.630	D692
318i		1.9	1996-1998		HB136x.690	D558	HB227x.630	D692
318ic		1.8	1991-1991		HB195x.640	D278	HB399x.630	D279
318ic		1.8	1992-1992		HB136x.690	D558	HB227x.630	D692
318ic		1.8	1994-1995		HB136x.690	D558	HB227x.630	D692
318ic		1.9	1996-1997		HB136x.690	D558	HB227x.630	D692
318is		1.8	1991-1991		HB195x.640	D278	HB399x.630	D279
318is		1.8	1992-1995		HB136x.690	D558	HB227x.630	D692
318is		1.9	1996-1997		HB136x.690	D558	HB227x.630	D692
318ti		1.8	1995-1995		HB136x.690	D558	HB227x.630	D692
318ti		1.9	1996-1998		HB136x.690	D558	HB227x.630	D692
318ti		1.9	1999-1999		HB136x.690	D558	HB136x.690	D588
320i		1.8	1980-1982		HB180x.640	D961		
320i		2.0	1977-1979		HB180x.640	D961		
323ci		2.5	2000-2000		HB546x.654	D781	HB227x.630	D692
323i	Sport Wagon	2.5	2000-2000		HB546x.654	D781	HB227x.630	D692
323i		2.5	1999-2000		HB546x.654	D781	HB227x.630	D692
323ic		2.5	1998-1999		HB546x.654	D781		
323is		2.5	1998-1999		HB546x.654	D781	HB227x.630	D692
325ci		2.5	2001-2006		HB136x.690	D558	HB227x.630	D692
325e		2.7	1984-1987		HB195x.640	D278	HB399x.630	D279
325es		2.7	1986-1987		HB195x.640	D278	HB399x.630	D279
325i	Sport Wagon	2.5	2001-2003		HB136x.690	D558	HB227x.630	D692
325i		2.5	1987-1991		HB195x.640	D278	HB399x.630	D279
325i		2.5	2001-2005		HB546x.654	D781	HB227x.630	D692
325i		3.0	2006-2006		HB534x.750	D1061		
325is		2.5	1987-1991		HB195x.640	D278	HB399x.630	D279
325is		2.5	1992-1995		HB136x.690	D558	HB227x.630	D692
325iX		2.5	1988-1991		HB195x.640	D278	HB399x.630	D279
325xi	Sport Wagon	2.5	2001-2003		HB136x.690	D558	HB227x.630	D692
325xi		2.5	2001-2005		HB136x.690	D558	HB227x.630	D692
325xi		3.0	2006-2006		HB534x.750	D1061		
328ci		2.8	2000-2000		HB136x.690	D558	HB227x.630	D692
328i		2.8	1998-2000		HB546x.654	D781	HB227x.630	D692
328i		3.0	2007-2007		HB534x.750	D1061		
328i		3.0	2008-2008		HB551x.748	D918		
328ic		2.8	1998-1999		HB136x.690	D558	HB227x.630	D692
328is		2.8	1998-1999		HB136x.690	D558	HB227x.630	D692
328xi		3.0	2007-2007		HB534x.750	D1061		
328xi		3.0	2008-2008		HB551x.748	D918		
330ci		3.0	2001-2006		HB464x.764	D946	HB518x.642	D683
330i		3.0	2001-2005		HB464x.764	D946	HB518x.642	D683
330i		3.0	2006-2006		HB534x.750	D1061		
330xi		3.0	2001-2005		HB464x.764	D946	HB518x.642	D683
330xi		3.0	2006-2006		HB534x.750	D1061		
335i		3.0	2007-2008		HB551x.748	D918		
335xi		3.0	2007-2008		HB551x.748	D918		
524TD		2.4	1985-1986		HB137x.690	D395	HB399x.630	D279
525i	Sport Wagon	2.5	2001-2003		HB465x.764	D947	HB227x.630	D692
525i		2.5	1989-1995		HB135x.770	D394	HB227x.630	D692
525i		2.5	2001-2003		HB465x.764	D947	HB227x.630	D692

CODE Breakdown

HB 245 x .631

Insert Compound Code

Make/Model	Submodel	Engine (Liter)	Years	Note	FRONT		REAR	
					Hawk #	FMSI	Hawk #	FMSI
BMW CONT.								
525i		2.5	2004-2005	Manual Trans	HB534x.750	D1061	HB458x.642	D1042
525i		2.5	2004-2005	Automatic Trans	HB551x.748	D918	HB458x.642	D1042
525i		3.0	2006-2006		HB551x.748	D918	HB458x.642	D1042
525i		3.0	2007-2007		HB534x.750	D1061	HB518x.642	D683
525iT		2.5	1993-1995		HB135x.770	D394	HB227x.630	D692
525xi		3.0	2006-2007		HB551x.748	D918	HB458x.642	D1042
528e		2.7	1982-1988		HB137x.690	D395	HB399x.630	D279
528i		2.8	1979-1981		HB206x.565	D163	HB227x.630	D692
528i		2.8	1997-1998		HB135x.770	D394	HB227x.630	D692
528i		2.8	2000-2000		HB465x.764	D947		
528i		3.0	2008-2008		HB551x.748	D918	HB458x.642	D1042
528iT		2.8	1999-2000		HB465x.764	D947	HB227x.630	D692
528xi		3.0	2008-2008		HB551x.748	D918	HB458x.642	D1042
530i		3.0	1975-1978		HB206x.565	D163		
530i		3.0	1994-1995		HB135x.770	D394	HB227x.630	D692
530i		3.0	2001-2003		HB325x.720	D681	HB227x.630	D692
530i		3.0	2004-2007		HB551x.748	D918	HB458x.642	D1042
530iT		3.0	1994-1995		HB135x.770	D394	HB227x.630	D692
530xi		3.0	2006-2007		HB551x.748	D918	HB458x.642	D1042
533i		3.2	1983-1984		HB137x.690	D395	HB399x.630	D279
535i		3.0	2008-2008		HB551x.748	D918	HB458x.642	D1042
535i		3.5	1985-1987		HB137x.690	D395		
535i		3.5	1988-1993		HB135x.770	D394	HB227x.630	D692
535is		3.5	1988-1988		HB137x.690	D395		
535xi		3.0	2008-2008		HB551x.748	D918	HB458x.642	D1042
540i	Sport Wagon	4.4	2001-2003		HB325x.720	D681	HB227x.630	D692
540i		4.0	1994-1995		HB135x.770	D394	HB227x.630	D692
540i		4.4	1997-2003		HB325x.720	D681	HB227x.630	D692
540iT		4.4	2000-2000		HB325x.720	D681	HB227x.630	D692
545i		4.4	2004-2005		HB551x.748	D918		
550i		4.8	2006-2008		HB551x.748	D918		
630csi		3.0	1977-1977		HB206x.565	D163		
633csi		3.2	1979-1982		HB206x.565	D163		
635csi		3.5	1985-1988		HB137x.690	D395	HB399x.630	D279
645ci		4.4	2004-2005		HB551x.748	D918		
650i		4.8	2006-2008		HB551x.748	D918		
733i		3.2	1978-1982		HB206x.565	D163		
735i		3.5	1986-1986		HB206x.565	D163	HB399x.630	D279
735i		3.5	1987-1991		HB135x.770	D394	HB227x.630	D692
735iL		3.5	1988-1992		HB135x.770	D394	HB227x.630	D692
740i		4.0	1993-1994		HB135x.770	D394	HB227x.630	D692
740i		4.0	1995-1995		HB325x.720	D681	HB518x.642	D683
740i		4.4	1997-2001		HB325x.720	D681	HB518x.642	D683
740iL		4.0	1993-1994		HB135x.642	D394	HB227x.630	D692
740iL		4.0	1995-1995		HB325x.720	D681	HB518x.642	D683
740iL		4.4	1996-1998		HB325x.720	D681	HB518x.642	D683
745i		4.4	2002-2005		HB551x.748	D918		
745iL		4.4	2002-2005		HB551x.748	D918		
750i		4.8	2006-2008		HB551x.748	D918		
750iL		5.0	1988-1994		HB135x.770	D394	HB227x.630	D692
750iL		5.4	1996-2001		HB497x.776	D682	HB518x.642	D683
750iL		4.8	2006-2008		HB551x.748	D918		

RACE COMPOUND CODES

DTC-70 - U | DTC-05 - H | MT-4 - L | DR-97 - J
 DTC-60 - G | HT-14 - V | Blue 9012 - E | HP Plus - N
 DTC-30 - W | HT-10 - S | Black - M

STREET COMPOUND CODES

HPS Performance Street - F | SuperDuty - P
 Performance Ceramic - Z
 LTS Light Truck & SUV - Y

Make/ Model	Submodel	Engine		Note	FRONT		REAR	
		(Liter)	Years		Hawk #	FMSI	Hawk #	FMSI
BMW CONT.								
760i		6.0	2004-2004		HB551x.748	D918	HB458x.642	D1042
760i		6.0	2005-2006		HB551x.748	D918		
760iL		6.0	2003-2007		HB551x.748	D918		
840ci		4.0	1994-1995		HB181x.660	D639	HB362x.642	D548
840ci		4.4	1996-1997		HB181x.660	D639	HB362x.642	D548
850ci		5.0	1993-1993		HB325x.720	D681	HB362x.642	D548
850ci		5.0	1994-1994		HB181x.660	D639	HB362x.642	D548
850ci		5.4	1995-1997		HB181x.660	D639	HB362x.642	D548
850csi		5.6	1994-1995		HB325x.720	D681	HB362x.642	D548
850i		5.0	1991-1992		HB325x.720	D681	HB362x.642	D548
Alpina Roadster		4.8	2003-2003		HB497x.776	D682		
M3		3.0	1995-1995		HB135x.770	D394	HB227x.630	D692
M3		3.2	1996-1998		HB135x.770	D394	HB227x.630	D692
M3		3.2	1999-1999		HB135x.642	D394		
M3		3.2	2001-2001		HB135x.770	D394		
M3		3.2	2002-2002		HB135x.770	D394	HB362x.642	D548
M3		3.2	2003-2006		HB464x.764	D946	HB518x.642	D683
M3		4.0	2008-2008		HB551x.748	D918		
M5		3.6	1991-1993		HB135x.770	D394	HB227x.630	D692
M5		5.0	2000-2003		HB325x.720	D681	HB518x.642	D683
X3	2.5i	2.5	2005-2005		HB464x.764	D946	HB518x.642	D683
X3	3.0i	3.0	2005-2006		HB464x.764	D946	HB518x.642	D683
X3	3.0si	3.0	2007-2007		HB464x.764	D946		
X3	3.0si	3.0	2008-2008		HB464x.764	D946	HB518x.642	D683
X3		2.5	2004-2004		HB464x.764	D946	HB518x.642	D683
X3		3.0	2004-2004		HB464x.764	D946	HB518x.642	D683
X5	3.0i	3.0	2005-2006		HB325x.720	D681	HB518x.642	D683
X5	4.4i	4.4	2005-2006		HB325x.720	D681	HB518x.642	D683
X5	4.8is	4.8	2004-2006		HB325x.720	D681	HB518x.642	D683
X5	is	4.6	2002-2003		HB325x.720	D681	HB518x.642	D683
X5		3.0	2001-2004		HB325x.720	D681	HB518x.642	D683
X5		4.4	2000-2004		HB325x.720	D681	HB518x.642	D683
Z3	Coupe	2.8	1999-2000		HB135x.770	D394	HB227x.630	D692
Z3	Coupe	3.0	2001-2002		HB135x.770	D394	HB227x.630	D692
Z3	M Coupe	3.2	1999-2002		HB135x.770	D394	HB227x.630	D692
Z3	M Roadster	3.2	1998-2002		HB135x.770	D394	HB227x.630	D692
Z3	Roadster	1.9	1996-1998		HB136x.690	D558	HB227x.630	D692
Z3	Roadster	2.5	1999-2002		HB136x.690	D558	HB227x.630	D692
Z3	Roadster	2.8	1997-2000		HB136x.690	D558	HB227x.630	D692
Z3	Roadster	3.0	2001-2002		HB136x.690	D558	HB227x.630	D692
Z4	2.5i	2.5	2004-2005		HB136x.690	D558	HB227x.630	D692
Z4	3.0i	3.0	2004-2005		HB136x.690	D558	HB227x.630	D692
Z4	Coupe 3.0si	3.0	2006-2006		HB136x.690	D558	HB227x.630	D692
Z4	Coupe 3.0si	3.0	2007-2008		HB136x.690	D558		
Z4	M Coupe	3.2	2006-2007		HB464x.764	D946		
Z4	M Coupe	3.2	2008-2008		HB464x.764		HB518x.642	D683
Z4	M Roadster	3.2	2006-2006		HB464x.764		HB518x.642	D683
Z4	M Roadster	3.2	2007-2007		HB464x.764	D946		
Z4	Roadster	2.5	2003-2003		HB136x.690	D558	HB227x.630	D692
Z4	Roadster	3.0	2003-2003		HB136x.690	D558	HB227x.630	D692
Z4	Roadster 3.0i	3.0	2006-2006		HB136x.690	D558	HB227x.630	D692
Z4	Roadster 3.0i	3.0	2007-2007		HB136x.690	D558		

CODE Breakdown

HB 245 x .631

Insert Compound Code

Make/Model	Submodel	Engine (Liter)	Years	Note	FRONT		REAR	
					Hawk #	FMSI	Hawk #	FMSI
BMW CONT.								
Z4	Roadster 3.0i	3.0	2008-2008		HB136x.690	D558	HB136x.690	D588
Z4	Roadster 3.0si	3.0	2006-2006		HB136x.690	D558	HB227x.630	D692
Z4	Roadster 3.0si	3.0	2007-2008		HB136x.690	D558		
Z8		5.0	2000-2003		HB497x.776	D682	HB518x.642	D683
BUICK								
Apollo	SR	4.1	1975-1975		HB103x.590	D313		
Apollo	SR	4.3	1975-1975		HB103x.590	D313		
Apollo	SR	5.7	1975-1975		HB103x.590	D313		
Apollo		4.1	1973-1975		HB103x.590	D313		
Apollo		4.3	1975-1975		HB103x.590	D313		
Apollo		5.7	1973-1975		HB103x.590	D313		
Centurion		5.7	1972-1973		HB103x.590	D313		
Centurion		7.5	1972-1973		HB103x.590	D313		
Century	Custom	2.2	1993-1994		HB396x.630	D215		
Century	Custom	2.5	1982-1986		HB400x.630	D159		
Century	Custom	2.5	1987-1989	w/Heavy Duty Brakes	HB396x.630	D215		
Century	Custom	2.5	1987-1989	w/Standard Brakes	HB400x.630	D159		
Century	Custom	2.5	1990-1992		HB396x.630	D215		
Century	Custom	2.8	1986-1986		HB400x.630	D159		
Century	Custom	2.8	1987-1989	w/Heavy Duty Brakes	HB396x.630	D215		
Century	Custom	2.8	1987-1989	w/Standard Brakes	HB400x.630	D159		
Century	Custom	3.0	1982-1985		HB400x.630	D159		
Century	Custom	3.1	1994-1996		HB396x.630	D215		
Century	Custom	3.1	1997-2000		HB360x.670	D699		
Century	Custom	3.1	2001-2005		HB360x.670	D699	HB359x.543	D814
Century	Custom	3.2	1978-1979		HB119x.594	D154		
Century	Custom	3.3	1989-1989	w/Heavy Duty Brakes	HB396x.630	D215		
Century	Custom	3.3	1989-1989	w/Standard Brakes	HB400x.630	D159		
Century	Custom	3.3	1990-1993		HB396x.630	D215		
Century	Custom	3.8	1975-1977		HB103x.590	D313		
Century	Custom	3.8	1978-1979		HB119x.594	D154		
Century	Custom	3.8	1984-1986		HB400x.630	D159		
Century	Custom	3.8	1987-1988	w/Heavy Duty Brakes	HB396x.630	D215		
Century	Custom	3.8	1987-1988	w/Standard Brakes	HB400x.630	D159		
Century	Custom	4.3	1982-1982		HB400x.630	D159		
Century	Custom	4.3	1983-1985		HB396x.630	D215		
Century	Custom	4.9	1979-1979		HB119x.594	D154		
Century	Custom	5.0	1977-1977		HB103x.590	D313		
Century	Custom	5.0	1978-1979		HB119x.594	D154		
Century	Custom	5.7	1975-1977		HB103x.590	D313		
Century	Custom	5.7	1978-1979		HB119x.594	D154		
Century	Custom	6.6	1977-1977		HB103x.590	D313		
Century	Estate Wagon	2.5	1984-1986		HB400x.630	D159		
Century	Estate Wagon	2.5	1987-1989	w/Heavy Duty Brakes	HB396x.630	D215		
Century	Estate Wagon	2.5	1987-1989	w/Standard Brakes	HB400x.630	D159		
Century	Estate Wagon	2.8	1986-1986		HB400x.630	D159		
Century	Estate Wagon	2.8	1987-1988	w/Heavy Duty Brakes	HB396x.630	D215		
Century	Estate Wagon	2.8	1987-1988	w/Standard Brakes	HB400x.630	D159		
Century	Estate Wagon	3.0	1984-1985		HB400x.630	D159		
Century	Estate Wagon	3.3	1989-1989	w/Heavy Duty Brakes	HB396x.630	D215		
Century	Estate Wagon	3.3	1989-1989	w/Standard Brakes	HB400x.630	D159		
Century	Estate Wagon	3.8	1980-1981		HB119x.594	D154		

RACE COMPOUND CODES

DTC-70 - U	DTC-05 - H	MT-4 - L	DR-97 - J
DTC-60 - G	HT-14 - V	Blue 9012 - E	HP Plus - N
DTC-30 - W	HT-10 - S	Black - M	

STREET COMPOUND CODES

HPS Performance Street - F	SuperDuty - P
Performance Ceramic - Z	
LTS Light Truck & SUV - Y	

Make/Model	Submodel	Engine (Liter)	Years	Note	FRONT		REAR	
					Hawk #	FMSI	Hawk #	FMSI
BUICK CONT.								
Century	Estate Wagon	3.8	1984-1986		HB400x.630	D159		
Century	Estate Wagon	3.8	1987-1988	w/Heavy Duty Brakes	HB396x.630	D215		
Century	Estate Wagon	3.8	1987-1988	w/Standard Brakes	HB400x.630	D159		
Century	Estate Wagon	4.3	1980-1981		HB119x.594	D154		
Century	Estate Wagon	4.3	1984-1985		HB396x.630	D215		
Century	Estate Wagon	4.9	1980-1980		HB119x.594	D154		
Century	Estate Wagon	5.0	1980-1980		HB119x.594	D154		
Century	Estate Wagon	5.7	1981-1981		HB119x.594	D154		
Century	Limited	2.2	1993-1993		HB396x.630	D215		
Century	Limited	2.5	1983-1992		HB396x.630	D215		
Century	Limited	2.8	1986-1989		HB396x.630	D215		
Century	Limited	3.0	1983-1985		HB396x.630	D215		
Century	Limited	3.1	1997-2005		HB360x.670	D699		
Century	Limited	3.2	1978-1979		HB119x.594	D154		
Century	Limited	3.3	1989-1993		HB396x.630	D215		
Century	Limited	3.8	1978-1981		HB119x.594	D154		
Century	Limited	3.8	1984-1988		HB396x.630	D215		
Century	Limited	4.3	1980-1981		HB119x.594	D154		
Century	Limited	4.3	1983-1985		HB396x.630	D215		
Century	Limited	4.9	1979-1980		HB119x.594	D154		
Century	Limited	5.0	1978-1980		HB119x.594	D154		
Century	Limited	5.7	1981-1981		HB119x.594	D154		
Century	Luxus	5.7	1973-1974		HB103x.590	D313		
Century	Luxus	7.5	1973-1974		HB103x.590	D313		
Century	Special	2.2	1993-1996		HB396x.630	D215		
Century	Special	2.5	1991-1992		HB396x.630	D215		
Century	Special	3.1	1994-1996		HB396x.630	D215		
Century	Special	3.2	1978-1979		HB119x.594	D154		
Century	Special	3.3	1991-1993		HB396x.630	D215		
Century	Special	3.8	1975-1977		HB103x.590	D313		
Century	Special	3.8	1978-1979		HB119x.594	D154		
Century	Special	4.9	1979-1979		HB119x.594	D154		
Century	Special	5.0	1978-1979		HB119x.594	D154		
Century	Special	5.7	1979-1979		HB119x.594	D154		
Century	Special Edition	3.1	2005-2005		HB360x.670	D699	HB359x.543	D814
Century	Sport	3.2	1978-1979		HB119x.594	D154		
Century	Sport	3.8	1978-1980		HB119x.594	D154		
Century	Sport	4.9	1979-1980		HB119x.594	D154		
Century	Sport	5.0	1978-1978		HB119x.594	D154		
Century	T-Type	3.0	1983-1984	w/Heavy Duty Brakes	HB396x.630	D215		
Century	T-Type	3.0	1983-1984	w/Standard Brakes	HB400x.630	D159		
Century	T-Type	3.8	1984-1986	w/Heavy Duty Brakes	HB396x.630	D215		
Century	T-Type	3.8	1984-1986	w/Standard Brakes	HB400x.630	D159		
Century		3.1	2003-2003		HB360x.670	D699	HB359x.543	D814
Century		3.8	1975-1977		HB103x.590	D313		
Century		3.8	1980-1981		HB119x.594	D154		
Century		4.3	1980-1981		HB119x.594	D154		
Century		4.9	1980-1980		HB119x.594	D154		
Century		5.0	1977-1977		HB103x.590	D313		
Century		5.0	1980-1980		HB119x.594	D154		
Century		5.7	1973-1977		HB103x.590	D313		
Century		5.7	1981-1981		HB119x.594	D154		

CODE Breakdown

HB 245 x .631

Insert Compound Code

Make/Model	Submodel	Engine (Liter)	Years	Note	FRONT		REAR	
					Hawk #	FMSI	Hawk #	FMSI
BUICK CONT.								
Century		7.5	1973-1974		HB103x.590	D313		
Electra	225	5.7	1977-1978		HB103x.590	D313	HB103x.590	D313
Electra	225	5.7	1979-1979		HB103x.590	D313		
Electra	225	6.6	1977-1978		HB103x.590	D313	HB103x.590	D313
Electra	225	6.6	1979-1979		HB103x.590	D313		
Electra	225	7.5	1972-1974		HB103x.590	D313	HB103x.590	D313
Electra	225	7.5	1976-1976		HB103x.590	D313	HB103x.590	D313
Electra	300	3.0	1985-1985		HB396x.630	D215		
Electra	300	3.8	1985-1985		HB396x.630	D215		
Electra	300	4.3	1985-1985		HB396x.630	D215		
Electra	225 Custom	7.5	1972-1975		HB103x.590	D313	HB103x.590	D313
Electra	225 Limited	5.7	1977-1977		HB103x.590	D313	HB103x.590	D313
Electra	225 Limited	6.6	1977-1977		HB103x.590	D313	HB103x.590	D313
Electra	225 Limited	7.5	1974-1975		HB103x.590	D313	HB103x.590	D313
Electra	Estate Wagon	4.9	1980-1980		HB103x.590	D313		
Electra	Estate Wagon	5.0	1981-1989		HB103x.590	D313		
Electra	Estate Wagon	5.7	1980-1985		HB103x.590	D313		
Electra	Limited	3.8	1987-1990		HB396x.630	D215		
Electra	Limited	4.1	1980-1984		HB103x.590	D313		
Electra	Limited	5.0	1981-1984		HB103x.590	D313		
Electra	Limited	5.7	1978-1978		HB103x.590	D313	HB103x.590	D313
Electra	Limited	5.7	1979-1983		HB103x.590	D313		
Electra	Limited	6.6	1978-1978		HB103x.590	D313	HB103x.590	D313
Electra	Limited	6.6	1979-1979		HB103x.590	D313		
Electra	Limited	7.5	1976-1976		HB103x.590	D313	HB103x.590	D313
Electra	Park Avenue	3.8	1985-1990		HB396x.630	D215		
Electra	Park Avenue	4.1	1980-1984		HB103x.590	D313		
Electra	Park Avenue	4.3	1985-1985		HB396x.630	D215		
Electra	Park Avenue	5.0	1981-1984		HB103x.590	D313		
Electra	Park Avenue	5.7	1978-1978		HB103x.590	D313	HB103x.590	D313
Electra	Park Avenue	5.7	1979-1983		HB103x.590	D313		
Electra	Park Avenue	6.6	1978-1978		HB103x.590	D313	HB103x.590	D313
Electra	Park Avenue	6.6	1979-1979		HB103x.590	D313		
Electra	Park Avenue Ultra	3.8	1990-1990		HB396x.630	D215		
Electra	T-Type	3.8	1985-1990		HB396x.630	D215		
Electra	Ultra	3.8	1989-1989		HB396x.630	D215		
Electra		3.8	1986-1986		HB396x.630	D215		
Electra		7.5	1973-1973		HB103x.590	D313	HB103x.590	D313
Estate Wagon		5.7	1972-1973		HB103x.590	D313		
Estate Wagon		5.7	1977-1979		HB103x.590	D313		
Estate Wagon		6.6	1977-1979		HB103x.590	D313		
Estate Wagon		7.5	1972-1976		HB103x.590	D313		
GS		5.7	1972-1972		HB103x.590	D313		
GS 455		7.5	1972-1972		HB103x.590	D313		
Lacrosse	CX	3.8	2005-2008		HB360x.670	D699	HB450x.555	D999
Lacrosse	CX	3.8	2009-2009		HB535x.638	D1159	HB359x.543	D814
Lacrosse	CXL	3.8	2005-2008		HB360x.670	D699	HB450x.555	D999
Lacrosse	CXL	3.8	2009-2009		HB535x.638	D1159	HB359x.543	D814
Lacrosse	CXS	3.6	2005-2008		HB360x.670	D699	HB450x.555	D999
Lacrosse	Super	5.3	2008-2008		HB535x.638	D1159	HB450x.555	D999
Lacrosse	Super	5.3	2009-2009		HB535x.638	D1159	HB359x.543	D814
Lesabre	Custom	3.0	1986-1986		HB103x.590	D313		
Lesabre	Custom	3.8	1977-1978		HB103x.590	D313		

RACE COMPOUND CODES

DTC-70 - U | DTC-05 - H | MT-4 - L | DR-97 - J
 DTC-60 - G | HT-14 - V | Blue 9012 - E | HP Plus - N
 DTC-30 - W | HT-10 - S | Black - M

STREET COMPOUND CODES

HPS Performance Street - F | SuperDuty - P
 Performance Ceramic - Z
 LTS Light Truck & SUV - Y

Make/Model	Submodel	Engine		Note	FRONT		REAR	
		(Liter)	Years		Hawk #	FMSI	Hawk #	FMSI
BUICK CONT.								
Lesabre	Custom	3.8	1982-1990		HB103x.590	D313		
Lesabre	Custom	3.8	1992-1993		HB129x.681	D505		
Lesabre	Custom	3.8	1994-1998		HB217x.681	D623		
Lesabre	Custom	3.8	2000-2005		HB360x.670	D699	HB359x.543	D814
Lesabre	Custom	4.1	1982-1984		HB103x.590	D313		
Lesabre	Custom	4.9	1977-1978		HB103x.590	D313		
Lesabre	Custom	5.0	1978-1978		HB103x.590	D313		
Lesabre	Custom	5.0	1982-1985		HB103x.590	D313		
Lesabre	Custom	5.7	1972-1973		HB103x.590	D313		
Lesabre	Custom	5.7	1975-1978		HB103x.590	D313		
Lesabre	Custom	5.7	1982-1985		HB103x.590	D313		
Lesabre	Custom	6.6	1975-1975		HB103x.590	D313		
Lesabre	Custom	6.6	1977-1978		HB103x.590	D313		
Lesabre	Custom	7.5	1972-1973		HB103x.590	D313		
Lesabre	Custom	7.5	1975-1976		HB103x.590	D313		
Lesabre	Estate Wagon	4.9	1980-1980		HB103x.590	D313		
Lesabre	Estate Wagon	5.0	1981-1983		HB103x.590	D313		
Lesabre	Estate Wagon	5.0	1985-1990		HB103x.590	D313		
Lesabre	Estate Wagon	5.7	1980-1983		HB103x.590	D313		
Lesabre	Estate Wagon	5.7	1985-1985		HB103x.590	D313		
Lesabre	Limited	3.0	1986-1986		HB396x.630	D215		
Lesabre	Limited	3.8	1979-1985		HB103x.590	D313		
Lesabre	Limited	3.8	1986-1991		HB396x.630	D215		
Lesabre	Limited	3.8	1992-1993		HB129x.681	D505		
Lesabre	Limited	3.8	1994-1998		HB217x.681	D623		
Lesabre	Limited	3.8	2000-2005		HB360x.670	D699	HB359x.543	D814
Lesabre	Limited	4.1	1980-1984		HB103x.590	D313		
Lesabre	Limited	4.9	1979-1980		HB103x.590	D313		
Lesabre	Limited	5.0	1981-1985		HB103x.590	D313		
Lesabre	Limited	5.7	1979-1985		HB103x.590	D313		
Lesabre	Luxus	5.7	1974-1974		HB103x.590	D313		
Lesabre	Luxus	7.5	1974-1974		HB103x.590	D313		
Lesabre	Sport	3.8	1978-1980		HB103x.590	D313		
Lesabre		3.8	1976-1981		HB103x.590	D313		
Lesabre		3.8	1987-1991		HB396x.630	D215		
Lesabre		3.8	1999-1999		HB217x.681	D623		
Lesabre		4.1	1980-1981		HB103x.590	D313		
Lesabre		4.9	1977-1980		HB103x.590	D313		
Lesabre		5.0	1978-1978		HB103x.590	D313		
Lesabre		5.0	1981-1981		HB103x.590	D313		
Lesabre		5.7	1972-1975		HB103x.590	D313		
Lesabre		5.7	1977-1981		HB103x.590	D313		
Lesabre		6.6	1977-1978		HB103x.590	D313		
Lesabre		7.5	1972-1975		HB103x.590	D313		
Park Avenue	Ultra	3.8	1991-1993		HB129x.681	D505		
Park Avenue	Ultra	3.8	1994-1996		HB217x.681	D623		
Park Avenue	Ultra	3.8	1997-1998		HB360x.670	D699	HB359x.543	D814
Park Avenue	Ultra	3.8	2001-2005		HB360x.670	D699	HB359x.543	D814
Park Avenue		3.8	1991-1993		HB129x.681	D505		
Park Avenue		3.8	1994-1996		HB217x.681	D623		
Park Avenue		3.8	1997-2005		HB360x.670	D699	HB359x.543	D814
Ranier		4.2	2004-2005		HB382x.657	D882	HB383x.685	D883
Ranier		5.3	2004-2005		HB382x.657	D882	HB383x.685	D883

CODE Breakdown

HB 245 x .631

Insert Compound Code

Make/Model	Submodel	Engine (Liter)	Years	Note	FRONT		REAR	
					Hawk #	FMSI	Hawk #	FMSI
BUICK CONT.								
Regal	Custom	2.8	1988-1989		HB232x.681	D376	HB405x.543	D377
Regal	Custom	3.1	1989-1993		HB232x.681	D376	HB405x.543	D377
Regal	Custom	3.1	1994-1996		HB232x.681	D376	HB359x.543	D814
Regal	Custom	3.8	1990-1993		HB232x.681	D376	HB405x.543	D377
Regal	Custom	3.8	1994-1996		HB232x.681	D376	HB359x.543	D814
Regal	Estate Wagon	3.8	1982-1983		HB119x.594	D154		
Regal	Estate Wagon	4.1	1982-1983		HB119x.594	D154		
Regal	Estate Wagon	5.7	1982-1983		HB119x.594	D154		
Regal	Gran Sport	3.8	1992-1993		HB232x.681	D376	HB405x.543	D377
Regal	Gran Sport	3.8	1994-1996		HB232x.681	D376	HB359x.543	D814
Regal	Grand National	3.8	1984-1987		HB119x.594	D154		
Regal	GS	3.8	1997-1998		HB360x.670	D699	HB359x.543	D814
Regal	GS	3.8	2001-2004		HB360x.670	D699	HB359x.543	D814
Regal	Limited	2.8	1988-1989		HB232x.681	D376	HB405x.543	D377
Regal	Limited	3.1	1989-1993		HB232x.681	D376	HB405x.543	D377
Regal	Limited	3.2	1978-1979		HB119x.594	D154		
Regal	Limited	3.8	1978-1987		HB119x.594	D154		
Regal	Limited	3.8	1990-1993		HB232x.681	D376	HB405x.543	D377
Regal	Limited	3.8	1994-1996		HB232x.681	D376	HB359x.543	D814
Regal	Limited	4.1	1982-1984		HB119x.594	D154		
Regal	Limited	4.3	1980-1984		HB119x.594	D154		
Regal	Limited	4.9	1979-1980		HB119x.594	D154		
Regal	Limited	5.0	1978-1980		HB119x.594	D154		
Regal	Limited	5.0	1986-1987		HB119x.594	D154		
Regal	Limited	5.7	1981-1983		HB119x.594	D154		
Regal	LS	3.8	1997-1998		HB360x.670	D699	HB359x.543	D814
Regal	LS	3.8	2001-2004		HB360x.670	D699	HB359x.543	D814
Regal	Sport	3.8	1978-1982		HB119x.594	D154		
Regal	Sport	5.7	1981-1981		HB119x.594	D154		
Regal	T-Type	3.8	1983-1986		HB119x.594	D154		
Regal		3.2	1978-1979		HB119x.594	D154		
Regal		3.8	1975-1977		HB103x.590	D313		
Regal		3.8	1978-1984		HB119x.594	D154		
Regal		3.8	1999-2000		HB360x.670	D699	HB359x.543	D814
Regal		4.1	1982-1984		HB119x.594	D154		
Regal		4.3	1980-1984		HB119x.594	D154		
Regal		4.9	1979-1980		HB119x.594	D154		
Regal		5.0	1977-1977		HB103x.590	D313		
Regal		5.0	1978-1980		HB119x.594	D154		
Regal		5.7	1973-1977		HB103x.590	D313		
Regal		5.7	1981-1983		HB119x.594	D154		
Regal		7.5	1973-1974		HB103x.590	D313		
Rendezvous	CX	3.5	2006-2007		HB373x.689	D844	HB359x.543	D814
Rendezvous	CX	3.6	2006-2006		HB373x.689	D844	HB359x.543	D814
Rendezvous	CXL	3.5	2006-2007		HB373x.689	D844	HB359x.543	D814
Rendezvous	CXL	3.6	2006-2006		HB373x.689	D844	HB359x.543	D814
Rendezvous	CXL Plus	3.6	2005-2005		HB373x.689	D844	HB359x.543	D814
Rendezvous	Ultra	3.6	2004-2005		HB373x.689	D844	HB359x.543	D814
Rendezvous		3.4	2002-2005		HB373x.689	D844	HB359x.543	D814
Rendezvous		3.6	2004-2004		HB373x.689	D844	HB359x.543	D814
Riviera	S	3.8	1979-1980		HB119x.594	D154	HB119x.594	D154
Riviera	S	5.0	1980-1980		HB119x.594	D154	HB119x.594	D154
Riviera	S	5.7	1979-1980		HB119x.594	D154	HB119x.594	D154

RACE COMPOUND CODES

DTC-70 - U | DTC-05 - H | MT-4 - L | DR-97 - J
 DTC-60 - G | HT-14 - V | Blue 9012 - E | HP Plus - N
 DTC-30 - W | HT-10 - S | Black - M

STREET COMPOUND CODES

HPS Performance Street - F | SuperDuty - P
 Performance Ceramic - Z
 LTS Light Truck & SUV - Y

Make/Model	Submodel	Engine		Note	FRONT		REAR	
		(Liter)	Years		Hawk #	FMSI	Hawk #	FMSI
BUICK CONT.								
Riviera	T-Type	3.8	1981-1985		HB119x.594	D154	HB119x.594	D154
Riviera	T-Type	4.1	1981-1981		HB119x.594	D154	HB119x.594	D154
Riviera	T-Type	5.0	1981-1981		HB119x.594	D154	HB119x.594	D154
Riviera		3.8	1980-1981		HB119x.594	D154	HB119x.594	D154
Riviera		3.8	1984-1985		HB119x.594	D154	HB119x.594	D154
Riviera		3.8	1992-1993		HB129x.681	D505	HB359x.543	D814
Riviera		3.8	1995-1996		HB217x.681	D623	HB359x.543	D814
Riviera		3.8	1997-1999		HB360x.670	D699	HB359x.543	D814
Riviera		4.1	1981-1984		HB119x.594	D154	HB119x.594	D154
Riviera		5.0	1980-1985		HB119x.594	D154	HB119x.594	D154
Riviera		5.7	1977-1978		HB103x.590	D313		
Riviera		5.7	1979-1985		HB119x.594	D154	HB119x.594	D154
Riviera		6.6	1977-1978		HB103x.590	D313		
Riviera		7.5	1972-1976		HB103x.590	D313		
Roadmaster	Estate	5.0	1991-1991		HB103x.590	D313		
Roadmaster	Estate	5.7	1992-1995		HB103x.590	D313		
Roadmaster	Limited	5.7	1992-1996		HB103x.590	D313		
Roadmaster	Limited Wagon	5.7	1996-1996		HB103x.590	D313		
Roadmaster		5.0	1991-1991		HB103x.590	D313		
Roadmaster		5.7	1992-1996		HB103x.590	D313		
Skyhawk	Custom	1.8	1982-1984		HB400x.630	D159		
Skyhawk	Custom	1.8	1986-1986		HB400x.630	D159		
Skyhawk	Custom	2.0	1983-1987		HB400x.630	D159		
Skyhawk	Limited	1.8	1982-1986		HB400x.630	D159		
Skyhawk	Limited	2.0	1983-1987		HB400x.630	D159		
Skyhawk	Sport	1.8	1986-1986		HB400x.630	D159		
Skyhawk	Sport	2.0	1986-1987		HB400x.630	D159		
Skyhawk		2.0	1988-1989		HB400x.630	D159		
Skyhawk		3.8	1975-1975		HB103x.590	D313		
Skyhawk	Custom	2.3	1988-1989		HB400x.630	D159		
Skyhawk	Custom	2.3	1990-1990	w/Performance Package	HB390x.602	D506		
Skyhawk	Custom	2.3	1990-1990	w/o Performance Package	HB400x.630	D159		
Skyhawk	Custom	2.3	1991-1991		HB390x.602	D506		
Skyhawk	Custom	2.3	1993-1995		HB390x.602	D506		
Skyhawk	Custom	2.4	1996-1997		HB390x.602	D506		
Skyhawk	Custom	2.5	1983-1989		HB400x.630	D159		
Skyhawk	Custom	2.5	1990-1990	w/Performance Package	HB390x.602	D506		
Skyhawk	Custom	2.5	1990-1990	w/o Performance Package	HB400x.630	D159		
Skyhawk	Custom	2.5	1991-1991		HB390x.602	D506		
Skyhawk	Custom	2.8	1983-1985		HB400x.630	D159		
Skyhawk	Custom	3.0	1986-1988		HB400x.630	D159		
Skyhawk	Custom	3.1	1994-1997		HB390x.602	D506		
Skyhawk	Custom	3.3	1989-1989		HB400x.630	D159		
Skyhawk	Custom	3.3	1990-1990	w/Performance Package	HB390x.602	D506		
Skyhawk	Custom	3.3	1990-1990	w/o Performance Package	HB400x.630	D159		
Skyhawk	Custom	3.3	1991-1991		HB390x.602	D506		
Skyhawk	Custom	3.3	1993-1993		HB390x.602	D506		
Skyhawk	Custom	3.8	1978-1979		HB103x.590	D313		
Skyhawk	Custom	5.0	1978-1979		HB103x.590	D313		
Skyhawk	Custom	5.7	1972-1972		HB103x.590	D313		
Skyhawk	Custom	5.7	1978-1979		HB103x.590	D313		
Skyhawk	Custom	7.5	1972-1972		HB103x.590	D313		
Skyhawk	Gran Sport	2.3	1990-1990	w/Performance Package	HB390x.602	D506		

CODE Breakdown

HB 245 x .631

Insert Compound Code

Make/Model	Submodel	Engine (Liter)	Years	Note	FRONT		REAR	
					Hawk #	FMSI	Hawk #	FMSI
BUICK CONT.								
Skylark	Gran Sport	2.3	1990-1990	w/o Performance Package	HB400x.630	D159		
Skylark	Gran Sport	2.3	1991-1991		HB390x.602	D506		
Skylark	Gran Sport	2.5	1990-1990	w/Performance Package	HB390x.602	D506		
Skylark	Gran Sport	2.5	1990-1990	w/o Performance Package	HB400x.630	D159		
Skylark	Gran Sport	2.5	1991-1991		HB390x.602	D506		
Skylark	Gran Sport	3.1	1994-1997		HB390x.602	D506		
Skylark	Gran Sport	3.3	1990-1990	w/Performance Package	HB390x.602	D506		
Skylark	Gran Sport	3.3	1990-1990	w/o Performance Package	HB400x.630	D159		
Skylark	Gran Sport	3.3	1991-1993		HB390x.602	D506		
Skylark	Limited	2.3	1988-1989		HB400x.630	D159		
Skylark	Limited	2.3	1993-1995		HB390x.602	D506		
Skylark	Limited	2.4	1996-1997		HB390x.602	D506		
Skylark	Limited	2.5	1980-1989		HB400x.630	D159		
Skylark	Limited	2.8	1980-1985		HB400x.630	D159		
Skylark	Limited	3.0	1986-1988		HB400x.630	D159		
Skylark	Limited	3.1	1994-1997		HB390x.602	D506		
Skylark	Limited	3.3	1989-1989		HB400x.630	D159		
Skylark	Limited	3.3	1993-1993		HB390x.602	D506		
Skylark	Luxury Edition	2.3	1990-1990	w/Performance Package	HB390x.602	D506		
Skylark	Luxury Edition	2.3	1990-1990	w/o Performance Package	HB400x.630	D159		
Skylark	Luxury Edition	2.3	1991-1991		HB390x.602	D506		
Skylark	Luxury Edition	2.5	1990-1990	w/Performance Package	HB390x.602	D506		
Skylark	Luxury Edition	2.5	1990-1990	w/o Performance Package	HB400x.630	D159		
Skylark	Luxury Edition	2.5	1991-1991		HB390x.602	D506		
Skylark	Luxury Edition	3.3	1990-1990	w/Performance Package	HB390x.602	D506		
Skylark	Luxury Edition	3.3	1990-1990	w/o Performance Package	HB400x.630	D159		
Skylark	Luxury Edition	3.3	1991-1991		HB390x.602	D506		
Skylark	S	3.8	1976-1979		HB103x.590	D313		
Skylark	S	4.3	1976-1976		HB103x.590	D313		
Skylark	S	4.9	1977-1977		HB103x.590	D313		
Skylark	S	5.0	1977-1979		HB103x.590	D313		
Skylark	S	5.7	1976-1977		HB103x.590	D313		
Skylark	Sport	2.5	1980-1982		HB400x.630	D159		
Skylark	Sport	2.8	1980-1982		HB400x.630	D159		
Skylark	SR	3.8	1975-1977		HB103x.590	D313		
Skylark	SR	4.3	1975-1976		HB103x.590	D313		
Skylark	SR	4.9	1977-1977		HB103x.590	D313		
Skylark	SR	5.0	1977-1977		HB103x.590	D313		
Skylark	SR	5.7	1975-1977		HB103x.590	D313		
Skylark	T-Type	2.8	1983-1984		HB400x.630	D159		
Skylark		2.3	1991-1992		HB390x.602	D506		
Skylark		2.4	1998-1998		HB390x.602	D506		
Skylark		2.5	1980-1982		HB400x.630	D159		
Skylark		2.5	1990-1990	w/Performance Package	HB390x.602	D506		
Skylark		2.5	1990-1990	w/o Performance Package	HB400x.630	D159		
Skylark		2.5	1991-1991		HB390x.602	D506		
Skylark		2.8	1980-1982		HB400x.630	D159		
Skylark		3.1	1998-1998		HB390x.602	D506		
Skylark		3.3	1991-1992		HB390x.602	D506		
Skylark		3.8	1975-1979		HB103x.590	D313		
Skylark		4.3	1975-1976		HB103x.590	D313		
Skylark		4.9	1977-1977		HB103x.590	D313		
Skylark		5.0	1977-1979		HB103x.590	D313		

RACE COMPOUND CODES

DTC-70 - U	DTC-05 - H	MT-4 - L	DR-97 - J
DTC-60 - G	HT-14 - V	Blue 9012 - E	HP Plus - N
DTC-30 - W	HT-10 - S	Black - M	

STREET COMPOUND CODES

HPS Performance Street - F	SuperDuty - P
Performance Ceramic - Z	
LTS Light Truck & SUV - Y	

Make/Model	Submodel	Engine (Liter)	Years	Note	FRONT		REAR	
					Hawk #	FMSI	Hawk #	FMSI
BUICK CONT.								
Skylark		5.7	1972-1972		HB103x.590	D313		
Skylark		5.7	1975-1979		HB103x.590	D313		
Skylark		7.5	1972-1972		HB103x.590	D313		
Somerset	Limited	2.5	1986-1987		HB400x.630	D159		
Somerset	Limited	3.0	1986-1987		HB400x.630	D159		
Somerset	Regal	2.5	1985-1985		HB400x.630	D159		
Somerset	Regal	3.0	1985-1985		HB400x.630	D159		
Somerset	Regal Limited	2.5	1985-1985		HB400x.630	D159		
Somerset	Regal Limited	3.0	1985-1985		HB400x.630	D159		
Somerset	T-Type	2.5	1986-1986		HB400x.630	D159		
Somerset	T-Type	3.0	1986-1986		HB400x.630	D159		
Somerset		2.5	1986-1987		HB400x.630	D159		
Somerset		3.0	1986-1987		HB400x.630	D159		
SportWagon		5.7	1972-1972		HB103x.590	D313		
Terraza	CX	3.5	2005-2006		HB360x.670	D699		
Terraza	CX	3.9	2006-2007		HB360x.670	D699		
Terraza	CXL	3.5	2005-2006		HB360x.670	D699		
Terraza	CXL	3.9	2006-2007		HB360x.670	D699		
CADILLAC								
Allante		4.6	1993-1993		HB129x.681	D505	HB359x.543	D814
Catera		3.0	1997-2001		HB423x.709	D720	HB389x.583	D709
Cimarron		1.8	1982-1982		HB400x.630	D159		
Cimarron		2.0	1983-1986		HB400x.630	D159		
Cimarron		2.8	1985-1988		HB400x.630	D159		
Commercial Chassis		6.0	1980-1984		HB103x.590	D313		
Commercial Chassis		7.0	1977-1979		HB103x.590	D313		
Commercial Chassis		8.2	1975-1976		HB103x.590	D313		
Concours		4.6	1994-1996		HB217x.681	D623	HB359x.543	D814
Concours		4.6	1997-1999		HB360x.670	D699	HB359x.543	D814
CTS	V	5.7	2004-2005		HB453x.585	D1001	HB194x.570	D592
CTS	V	6.0	2006-2007		HB453x.585	D1001	HB194x.570	D592
CTS		2.8	2005-2005		HB439x.555	D921	HB440x.606	D922
CTS		2.8	2006-2007	w/o Performance Package	HB439x.555	D921	HB440x.606	D922
CTS		2.8	2006-2007	w/Performance Package	HB467x.540	D1019	HB440x.606	D922
CTS		3.2	2003-2004		HB439x.555	D921	HB440x.606	D922
CTS		3.6	2004-2005		HB439x.555	D921	HB440x.606	D922
CTS		3.6	2006-2007	w/o Performance Package	HB439x.555	D921	HB440x.606	D922
CTS		3.6	2006-2007	w/Performance Package	HB467x.540	D1019	HB440x.606	D922
DeVille	D-Elegance	4.6	1997-1997		HB360x.670	D699	HB359x.543	D814
DeVille	DHS	4.6	2001-2004	w/Heavy Duty Brakes	HB322x.717	D784	HB359x.543	D814
DeVille	DHS	4.6	2001-2004	w/Standard Brakes	HB360x.670	D699	HB359x.543	D814
DeVille	DTS	4.6	2001-2005	w/Heavy Duty Brakes	HB322x.717	D784	HB359x.543	D814
DeVille	DTS	4.6	2001-2005	w/Standard Brakes	HB360x.670	D699	HB359x.543	D814
DeVille	DTS	4.6	2005-2005		HB536x.704	D1076		
DeVille	Touring	4.9	1991-1993		HB129x.681	D505		
DeVille		4.1	1980-1984		HB103x.590	D313		
DeVille		4.1	1985-1987		HB396x.630	D215		
DeVille		4.3	1985-1985		HB396x.630	D215		
DeVille		4.5	1988-1990		HB396x.630	D215		
DeVille		4.6	1996-1996		HB217x.681	D623	HB359x.543	D814
DeVille		4.6	1997-1999		HB360x.670	D699	HB359x.543	D814
DeVille		4.6	2000-2005	w/Heavy Duty Brakes	HB322x.717	D784	HB359x.543	D814

CODE Breakdown

HB 245 x .631

Insert Compound Code

Make/Model	Submodel	Engine (Liter)	Years	Note	FRONT		REAR	
					Hawk #	FMSI	Hawk #	FMSI
CADILLAC CONT.								
DeVille		4.6	2000-2005	w/Standard Brakes	HB360x.670	D699	HB359x.543	D814
DeVille		4.6	2005-2005		HB536x.704	D1076		
DeVille		4.9	1991-1993		HB129x.681	D505		
DeVille		4.9	1994-1995		HB217x.681	D623	HB359x.543	D814
DeVille		5.7	1979-1984		HB103x.590	D313		
DeVille		6.0	1980-1981		HB103x.590	D313		
DeVille		7.0	1977-1979		HB103x.590	D313		
DeVille		7.7	1971-1974		HB103x.590	D313		
DeVille		8.2	1974-1976		HB103x.590	D313		
DTS	Platinum	4.6	2008-2008		HB322x.717	D784		
DTS		4.6	2006-2008		HB322x.717	D784		
El Dorado	Biarritz	4.1	1984-1985		HB119x.594	D154	HB119x.594	D154
El Dorado	ESC	4.6	2001-2002		HB360x.670	D699	HB359x.543	D814
El Dorado	ETC	4.6	1998-1998		HB360x.670	D699	HB359x.543	D814
El Dorado	ETC	4.6	2001-2002		HB360x.670	D699	HB359x.543	D814
El Dorado	Sport	4.6	1993-1993		HB129x.681	D505	HB359x.543	D814
El Dorado	Touring	4.6	1993-1993		HB129x.681	D505	HB359x.543	D814
El Dorado	Touring	4.6	1994-1996		HB217x.681	D623	HB359x.543	D814
El Dorado	Touring	4.6	1997-1997		HB360x.670	D699	HB359x.543	D814
El Dorado		4.1	1981-1985		HB119x.594	D154	HB119x.594	D154
El Dorado		4.6	1994-1996		HB217x.681	D623	HB359x.543	D814
El Dorado		4.6	1997-2000		HB360x.670	D699	HB359x.543	D814
El Dorado		4.9	1991-1991		HB129x.681	D505		
El Dorado		4.9	1992-1993		HB129x.681	D505	HB359x.543	D814
El Dorado		5.7	1979-1985		HB119x.594	D154	HB119x.594	D154
El Dorado		6.0	1980-1981		HB119x.594	D154	HB119x.594	D154
El Dorado		7.0	1977-1978		HB103x.590	D313		
El Dorado		8.2	1971-1976		HB103x.590	D313		
Escalade	ESV	6.2	2007-2008		HB561x.710	D1092	HB568x.666	D1194
Escalade	ESV Platinum	6.2	2008-2008		HB561x.710	D1092	HB568x.666	D1194
Escalade	EXT	6.2	2007-2008		HB561x.710	D1092	HB568x.666	D1194
Escalade	Platinum	6.2	2008-2008		HB561x.710	D1092	HB568x.666	D1194
Escalade		5.3	2002-2002	RWD	HB323x.724	D785	HB385x.640	D834
Escalade		5.3	2003-2005	RWD	HB323x.724	D785	HB494x.670	D974
Escalade		5.3	2003-2005	AWD	HB323x.724	D785	HB496x.640	D975
Escalade		5.7	1999-2000		HB332x.654	D369		
Escalade		6.0	2002-2002	RWD	HB323x.724	D785	HB385x.640	D834
Escalade		6.0	2003-2006	RWD	HB323x.724	D785	HB494x.670	D974
Escalade		6.0	2003-2006	AWD	HB323x.724	D785	HB496x.640	D975
Escalade		6.2	2007-2008		HB561x.710	D1092	HB568x.666	D1194
Fleetwood	75	4.1	1986-1986		HB396x.630	D215		
Fleetwood	75	7.7	1971-1974		HB103x.590	D313		
Fleetwood	75	8.2	1975-1976		HB103x.590	D313		
Fleetwood	60 Special	4.1	1987-1987		HB396x.630	D215		
Fleetwood	60 Special	4.5	1988-1990		HB396x.630	D215		
Fleetwood	60 Special	7.7	1971-1974		HB103x.590	D313		
Fleetwood	60 Special	8.2	1975-1976		HB103x.590	D313		
Fleetwood	60 Special Brougham	8.2	1974-1974		HB103x.590	D313		
Fleetwood	Brougham	4.1	1980-1985		HB103x.590	D313		
Fleetwood	Brougham	5.0	1986-1992		HB103x.590	D313		
Fleetwood	Brougham	5.7	1980-1985		HB103x.590	D313		
Fleetwood	Brougham	5.7	1990-1996		HB103x.590	D313		
Fleetwood	Brougham	6.0	1980-1981		HB103x.590	D313		

RACE COMPOUND CODES

DTC-70 - U	DTC-05 - H	MT-4 - L	DR-97 - J
DTC-60 - G	HT-14 - V	Blue 9012 - E	HP Plus - N
DTC-30 - W	HT-10 - S	Black - M	

STREET COMPOUND CODES

HPS Performance Street - F	SuperDuty - P
Performance Ceramic - Z	
LTS Light Truck & SUV - Y	

Make/Model	Submodel	Engine		Note	FRONT		REAR	
		(Liter)	Years		Hawk #	FMSI	Hawk #	FMSI
CADILLAC CONT.								
Fleetwood	Brougham	7.0	1977-1977		HB103x.590	D313		
Fleetwood	Brougham	7.0	1978-1978		HB103x.590	D313	HB103x.590	D313
Fleetwood	D-Elegance	4.1	1987-1987		HB396x.630	D215		
Fleetwood	D-Elegance	4.5	1988-1988		HB396x.630	D215		
Fleetwood	Formal	6.0	1980-1984		HB103x.590	D313		
Fleetwood	Formal	7.0	1977-1979		HB103x.590	D313		
Fleetwood		4.1	1985-1985		HB103x.590	D313		
Fleetwood		4.1	1986-1987		HB396x.630	D215		
Fleetwood		4.3	1985-1985		HB103x.590	D313		
Fleetwood		4.5	1988-1990		HB396x.630	D215		
Fleetwood		4.9	1991-1992		HB332x.654	D369		
Fleetwood		5.7	1993-1993		HB332x.654	D369		
Fleetwood		6.0	1980-1984		HB103x.590	D313		
Fleetwood		7.0	1977-1979		HB103x.590	D313		
Fleetwood		7.7	1971-1974		HB103x.590	D313		
Fleetwood		8.2	1976-1976		HB103x.590	D313		
Seville	SLS	4.6	1994-1996		HB217x.681	D623	HB359x.543	D814
Seville	SLS	4.6	1997-1998		HB360x.670	D699	HB359x.543	D814
Seville	SLS	4.6	2001-2003		HB360x.670	D699	HB359x.543	D814
Seville	SLS	4.6	2004-2004		HB360x.670	D699		
Seville	STS	4.6	1993-1993		HB129x.681	D505	HB359x.543	D814
Seville	STS	4.6	1994-1996		HB217x.681	D623	HB359x.543	D814
Seville	STS	4.6	1997-1998		HB360x.670	D699	HB359x.543	D814
Seville	STS	4.6	2001-2003		HB360x.670	D699	HB359x.543	D814
Seville	STS	4.9	1991-1992		HB129x.681	D505	HB359x.543	D814
Seville		4.1	1981-1985		HB119x.594	D154	HB119x.594	D154
Seville		4.6	1999-2000		HB360x.670	D699	HB359x.543	D814
Seville		4.9	1991-1991		HB129x.681	D505		
Seville		4.9	1992-1993		HB129x.681	D505	HB359x.543	D814
Seville		5.7	1976-1979		HB103x.590	D313		
Seville		5.7	1980-1985		HB119x.594	D154	HB119x.594	D154
Seville		6.0	1980-1981		HB119x.594	D154	HB119x.594	D154
SRX		3.6	2004-2008		HB467x.540	D1019		
SRX		4.6	2004-2008		HB467x.540	D1019		
STS	Platinum	3.6	2008-2008	w/Heavy Duty Brakes	HB194x.570	D592		
STS	Platinum	3.6	2008-2008	w/Heavy Duty Brakes	HB453x.585	D1001		
STS	Platinum	3.6	2008-2008	w/Standard Brakes	HB467x.540	D1019	HB440x.606	D922
STS	Platinum	4.6	2008-2008	w/Heavy Duty Brakes	HB194x.570	D592		
STS	Platinum	4.6	2008-2008	w/Heavy Duty Brakes	HB453x.585	D1001		
STS	Platinum	4.6	2008-2008	w/Standard Brakes	HB467x.540	D1019	HB440x.606	D922
STS	V	4.4	2006-2008		HB453x.585	D1001		
STS	V	4.4	2008-2008		HB439x.555	D921		
STS		3.6	2005-2005		HB439x.555	D921	HB440x.606	D922
STS		3.6	2006-2006	w/o Performance Package	HB439x.555	D921	HB440x.606	D922
STS		3.6	2006-2006	w/Performance Package	HB467x.540	D1019	HB440x.606	D922
STS		3.6	2007-2008		HB467x.540	D1019	HB440x.606	D922
STS		3.6	2008-2008		HB194x.570	D592	HB194x.570	D592
STS		3.6	2008-2008		HB439x.555	D921	HB194x.570	D592
STS		3.6	2008-2008		HB453x.585	D1001	HB194x.570	D592
STS		4.6	2005-2005		HB439x.555	D921	HB440x.606	D922
STS		4.6	2005-2005		HB467x.540	D1019	HB440x.606	D922
STS		4.6	2006-2006	w/o Performance Package	HB439x.555	D921	HB440x.606	D922
STS		4.6	2006-2006	w/Performance Package	HB467x.540	D1019	HB440x.606	D922

CODE Breakdown

HB 245 x .631

Insert Compound Code

Make/Model	Submodel	Engine (Liter)	Years	Note	FRONT		REAR	
					Hawk #	FMSI	Hawk #	FMSI
CADILLAC CONT.								
STS		4.6	2007-2008		HB467x.540	D1019	HB440x.606	D922
STS		4.6	2008-2008		HB194x.570	D592	HB194x.570	D592
STS		4.6	2008-2008		HB439x.555	D921	HB194x.570	D592
STS		4.6	2008-2008		HB453x.585	D1001	HB194x.570	D592
XLR	Platinum	4.6	2008-2008		HB247x.575	D731	HB248x.650	D732
XLR	Platinum	4.6	2008-2008		HB274x.610	D804	HB248x.650	D732
XLR	V	4.4	2006-2008		HB247x.575	D731	HB248x.650	D732
XLR	V	4.4	2008-2008		HB274x.610	D804		
XLR		4.6	2004-2008		HB247x.575	D731	HB248x.650	D732
XLR		4.6	2008-2008		HB274x.610	D804		
CHEVROLET								
Astro		2.5	1985-1989		HB103x.590	D313		
Astro		2.5	1990-1990	RWD	HB103x.590	D313		
Astro		2.5	1990-1990	AWD	HB332x.654	D369		
Astro		4.3	1985-1989		HB103x.590	D313		
Astro		4.3	1990-1992	RWD	HB103x.590	D313		
Astro		4.3	1990-2002	AWD	HB332x.654	D369		
Astro		4.3	2003-2005		HB323x.724	D785	HB324x.673	D792
Avalanche	LS	5.3	2007-2008		HB561x.710	D1092	HB568x.666	D1194
Avalanche	LT	5.3	2007-2008		HB561x.710	D1092	HB568x.666	D1194
Avalanche	LT	6.0	2007-2008		HB561x.710	D1092	HB568x.666	D1194
Avalanche	LTZ	5.3	2007-2008		HB561x.710	D1092	HB568x.666	D1194
Avalanche	LTZ	6.0	2007-2008		HB561x.710	D1092	HB568x.666	D1194
Avalanche 1500	LT	5.3	2006-2006	2WD	HB323x.724	D785	HB494x.670	D974
Avalanche 1500	LT	5.3	2006-2006	4WD	HB323x.724	D785	HB496x.640	D975
Avalanche 1500	Z66	5.3	2006-2006	2WD	HB323x.724	D785	HB494x.670	D974
Avalanche 1500	Z71	5.3	2006-2006	4WD	HB323x.724	D785	HB496x.640	D975
Avalanche 1500		5.3	2002-2005	2WD	HB323x.724	D785	HB494x.670	D974
Avalanche 1500		5.3	2002-2005	4WD	HB323x.724	D785	HB496x.640	D975
Avalanche 2500	LS	8.1	2006-2006		HB322x.717	D784	HB323x.724	D785
Avalanche 2500	LT	8.1	2006-2006		HB322x.717	D784	HB323x.724	D785
Bel Air		4.1	1968-1973		HB103x.590	D313		
Bel Air		5.0	1968-1968		HB103x.590	D313		
Bel Air		5.4	1968-1969		HB103x.590	D313		
Bel Air		5.7	1969-1975		HB103x.590	D313		
Bel Air		6.5	1968-1969		HB103x.590	D313		
Bel Air		6.6	1970-1975		HB103x.590	D313		
Bel Air		7.0	1968-1969		HB103x.590	D313		
Bel Air		7.4	1970-1975		HB103x.590	D313		
Beretta	GT	2.2	1992-1993		HB390x.602	D506		
Beretta	GT	2.8	1989-1989		HB400x.630	D159		
Beretta	GT	3.1	1990-1991		HB400x.630	D159		
Beretta	GT	3.1	1992-1993		HB390x.602	D506		
Beretta	GTZ	2.3	1990-1991		HB400x.630	D159		
Beretta	GTZ	2.3	1992-1993		HB390x.602	D506		
Beretta	GTZ	3.1	1991-1991		HB400x.630	D159		
Beretta	GTZ	3.1	1992-1993		HB390x.602	D506		
Beretta	Z26	2.3	1994-1994		HB390x.602	D506		
Beretta	Z26	3.1	1994-1996		HB390x.602	D506		
Beretta		2.0	1987-1989		HB400x.630	D159		
Beretta		2.2	1990-1991		HB400x.630	D159		
Beretta		2.2	1992-1996		HB390x.602	D506		

RACE COMPOUND CODES

DTC-70 - U	DTC-05 - H	MT-4 - L	DR-97 - J
DTC-60 - G	HT-14 - V	Blue 9012 - E	HP Plus - N
DTC-30 - W	HT-10 - S	Black - M	

STREET COMPOUND CODES

HPS Performance Street - F	SuperDuty - P
Performance Ceramic - Z	
LTS Light Truck & SUV - Y	

Make/Model	Submodel	Engine (Liter)	Years	Note	FRONT		REAR	
					Hawk #	FMSI	Hawk #	FMSI
CHEVROLET CONT.								
Beretta		2.8	1987-1989		HB400x.630	D159		
Beretta		3.1	1990-1991		HB400x.630	D159		
Beretta		3.1	1992-1996		HB390x.602	D506		
Blazer		4.1	1969-1982		HB103x.590	D313		
Blazer		4.8	1970-1970		HB103x.590	D313		
Blazer		4.8	1973-1973		HB103x.590	D313		
Blazer		5.0	1969-1973		HB103x.590	D313		
Blazer		5.0	1977-1987		HB103x.590	D313		
Blazer		5.7	1969-1991		HB103x.590	D313		
Blazer		5.7	1992-1994		HB332x.654	D369		
Blazer		6.2	1982-1991		HB103x.590	D313		
Blazer		6.5	1994-1994		HB332x.654	D369		
Blazer		6.6	1975-1979		HB103x.590	D313		
Blazer		7.4	1973-1973		HB103x.590	D313		
Blazer		7.4	1976-1978		HB103x.590	D313		
Blazer (S10 Series)		4.3	1995-1996		HB119x.594	D154		
Blazer (S10 Series)		4.3	1997-1997	Drum	HB119x.594	D154		
Blazer (S10 Series)		4.3	1997-1997	Disc	HB304x.598	D726	HB305x.610	D729
Blazer (S10 Series)		4.3	1998-2005		HB304x.598	D726	HB305x.610	D729
C10 Suburban		4.1	1970-1980		HB103x.590	D313		
C10 Suburban		4.8	1970-1971		HB103x.590	D313		
C10 Suburban		4.8	1973-1974		HB103x.590	D313		
C10 Suburban		5.0	1970-1973		HB103x.590	D313		
C10 Suburban		5.0	1976-1984		HB103x.590	D313		
C10 Suburban		5.7	1970-1984		HB103x.590	D313		
C10 Suburban		6.2	1982-1984		HB103x.590	D313		
C10 Suburban		6.6	1970-1972		HB103x.590	D313		
C10 Suburban		7.4	1973-1980		HB103x.590	D313		
C1500 Pickup		4.3	1988-1991	Extended Cab	HB332x.654	D369		
C1500 Pickup		4.3	1988-1991	Regular Cab	HB356x.654	D368		
C1500 Pickup		4.3	1992-1998		HB332x.654	D369		
C1500 Pickup		5.0	1988-1991	Extended Cab	HB332x.654	D369		
C1500 Pickup		5.0	1988-1991	Regular Cab	HB356x.654	D368		
C1500 Pickup		5.0	1992-1999		HB332x.654	D369		
C1500 Pickup		5.7	1988-1991	Extended Cab	HB332x.654	D369		
C1500 Pickup		5.7	1988-1991	Regular Cab	HB356x.654	D368		
C1500 Pickup		5.7	1992-1999		HB332x.654	D369		
C1500 Pickup		6.2	1988-1991	Extended Cab	HB332x.654	D369		
C1500 Pickup		6.2	1988-1991	Regular Cab	HB356x.654	D368		
C1500 Pickup		6.2	1992-1993		HB332x.654	D369		
C1500 Pickup		6.5	1994-1998		HB332x.654	D369		
C1500 Pickup		7.4	1990-1991	Extended Cab	HB332x.654	D369		
C1500 Pickup		7.4	1990-1991	Regular Cab	HB356x.654	D368		
C1500 Pickup		7.4	1992-1993		HB332x.654	D369		
C1500 Suburban		5.7	1992-1994		HB332x.654	D369		
C20 Pickup		4.1	1979-1984	w/13 in. Drums	HB131x.595	D614		
C20 Pickup		4.3	1985-1986	w/13 in. Drums	HB131x.595	D614		
C20 Pickup		4.8	1979-1986	w/13 in. Drums	HB131x.595	D614		
C20 Pickup		5.0	1979-1986	w/13 in. Drums	HB131x.595	D614		
C20 Pickup		5.7	1979-1986	w/13 in. Drums	HB131x.595	D614		
C20 Pickup		6.2	1982-1986	w/13 in. Drums	HB131x.595	D614		
C20 Pickup		6.6	1979-1980	w/13 in. Drums	HB131x.595	D614		
C20 Pickup		7.4	1979-1986	w/13 in. Drums	HB131x.595	D614		

CODE Breakdown

HB 245 x .631

Insert Compound Code

Make/Model	Submodel	Engine (Liter)	Years	Note	FRONT		REAR	
					Hawk #	FMSI	Hawk #	FMSI
CHEVROLET CONT.								
C20 Suburban		4.1	1970-1974		HB103x.590	D313		
C20 Suburban		4.8	1970-1978		HB103x.590	D313		
C20 Suburban		4.8	1979-1982	w/11 in. Drums	HB103x.590	D313		
C20 Suburban		4.8	1979-1982	w/13 in. Drums	HB131x.595	D614		
C20 Suburban		5.0	1970-1973		HB103x.590	D313		
C20 Suburban		5.0	1976-1978		HB103x.590	D313		
C20 Suburban		5.0	1979-1986	w/11 in. Drums	HB103x.590	D313		
C20 Suburban		5.0	1979-1986	w/13 in. Drums	HB131x.595	D614		
C20 Suburban		5.7	1970-1978		HB103x.590	D313		
C20 Suburban		5.7	1979-1986	w/11 in. Drums	HB103x.590	D313		
C20 Suburban		5.7	1979-1986	w/13 in. Drums	HB131x.595	D614		
C20 Suburban		6.2	1982-1986	w/11 in. Drums	HB103x.590	D313		
C20 Suburban		6.2	1982-1986	w/13 in. Drums	HB131x.595	D614		
C20 Suburban		6.6	1970-1972		HB103x.590	D313		
C20 Suburban		6.6	1976-1978		HB103x.590	D313		
C20 Suburban		6.6	1979-1980	w/11 in. Drums	HB103x.590	D313		
C20 Suburban		6.6	1979-1980	w/13 in. Drums	HB131x.595	D614		
C20 Suburban		7.4	1973-1978		HB103x.590	D313		
C20 Suburban		7.4	1979-1986	w/11 in. Drums	HB103x.590	D313		
C20 Suburban		7.4	1979-1986	w/13 in. Drums	HB131x.595	D614		
C2500 Pickup		4.3	1988-1995	8600 lbs. GVWR	HB296x.670	D370		
C2500 Pickup		4.3	1988-1995	7200 lbs. GVWR	HB332x.654	D369		
C2500 Pickup		5.0	1988-1998	8600 lbs. GVWR	HB296x.670	D370		
C2500 Pickup		5.0	1988-1998	7200 lbs. GVWR	HB332x.654	D369		
C2500 Pickup		5.7	1988-2000	8600 lbs. GVWR	HB296x.670	D370		
C2500 Pickup		5.7	1988-2000	7200 lbs. GVWR	HB332x.654	D369		
C2500 Pickup		6.2	1988-1993	8600 lbs. GVWR	HB296x.670	D370		
C2500 Pickup		6.2	1988-1993	7200 lbs. GVWR	HB332x.654	D369		
C2500 Pickup		6.5	1992-2000	8600 lbs. GVWR	HB296x.670	D370		
C2500 Pickup		6.5	1992-2000	7200 lbs. GVWR	HB332x.654	D369		
C2500 Pickup		7.4	1991-2000	8600 lbs. GVWR	HB296x.670	D370		
C2500 Pickup		7.4	1991-2000	7200 lbs. GVWR	HB332x.654	D369		
C2500 Suburban		5.7	1992-1999		HB332x.654	D369		
C2500 Suburban		6.5	1994-1999		HB332x.654	D369		
C2500 Suburban		7.4	1992-1999		HB332x.654	D369		
C30 Pickup		4.1	1979-1980	w/13 x 2.5 in. Drums	HB131x.595	D614		
C30 Pickup		4.1	1979-1980	w/13 x 2.5 in. Drums	HB337x.791	D149		
C30 Pickup		4.8	1979-1986	w/13 x 2.5 in. Drums	HB131x.595	D614		
C30 Pickup		4.8	1979-1986	w/13 x 2.5 in. Drums	HB337x.791	D149		
C30 Pickup		5.0	1979-1979	w/13 x 2.5 in. Drums	HB131x.595	D614		
C30 Pickup		5.0	1979-1979	w/13 x 2.5 in. Drums	HB337x.791	D149		
C30 Pickup		5.0	1986-1986	w/13 x 2.5 in. Drums	HB131x.595	D614		
C30 Pickup		5.0	1986-1986	w/13 x 2.5 in. Drums	HB337x.791	D149		
C30 Pickup		5.7	1979-1986	w/13 x 2.5 in. Drums	HB131x.595	D614		
C30 Pickup		5.7	1979-1986	w/13 x 2.5 in. Drums	HB337x.791	D149		
C30 Pickup		6.2	1982-1986	w/13 x 2.5 in. Drums	HB131x.595	D614		
C30 Pickup		6.2	1982-1986	w/13 x 2.5 in. Drums	HB337x.791	D149		
C30 Pickup		6.6	1979-1979	w/13 x 2.5 in. Drums	HB131x.595	D614		
C30 Pickup		6.6	1979-1979	w/13 x 2.5 in. Drums	HB337x.791	D149		
C30 Pickup		7.4	1979-1986	w/13 x 2.5 in. Drums	HB131x.595	D614		
C30 Pickup		7.4	1979-1986	w/13 x 2.5 in. Drums	HB337x.791	D149		
C3500 Pickup		5.7	1988-1989		HB296x.670	D370		
C3500 Pickup		5.7	1990-1991	Drum	HB296x.670	D370		

RACE COMPOUND CODES

DTC-70 - U	DTC-05 - H	MT-4 - L	DR-97 - J
DTC-60 - G	HT-14 - V	Blue 9012 - E	HP Plus - N
DTC-30 - W	HT-10 - S	Black - M	

STREET COMPOUND CODES

HPS Performance Street - F	SuperDuty - P
Performance Ceramic - Z	
LTS Light Truck & SUV - Y	

Make/Model	Submodel	Engine (Liter)	Years	Note	FRONT		REAR	
					Hawk #	FMSI	Hawk #	FMSI
CHEVROLET CONT.								
C3500 Pickup		5.7	1990-2000	Drum	HB298x.787	D459		
C3500 Pickup		5.7	1992-1993	Drum	HB296x.670	D370		
C3500 Pickup		5.7	1992-1994	Disc	HB337x.791	D149	HB337x.791	D149
C3500 Pickup		5.7	1994-1997	Disc	HB296x.670	D370	HB252x.860	D380
C3500 Pickup		5.7	1998-2000	Drum	HB296x.670	D370		
C3500 Pickup		6.2	1988-1989		HB296x.670	D370		
C3500 Pickup		6.2	1990-1991	Drum	HB296x.670	D370		
C3500 Pickup		6.2	1990-1993	Drum	HB298x.787	D459		
C3500 Pickup		6.2	1992-1993	Disc	HB296x.670	D370	HB337x.791	D149
C3500 Pickup		6.2	1992-1993	Disc	HB337x.791	D149	HB337x.791	D149
C3500 Pickup		6.5	1992-1994	Disc	HB337x.791	D149	HB337x.791	D149
C3500 Pickup		6.5	1992-1997	Drum	HB296x.670	D370		
C3500 Pickup		6.5	1998-2000	Drum	HB298x.787	D459		
C3500 Pickup		6.5	1998-2000	Drum	HB296x.670	D370		
C3500 Pickup		7.4	1988-1989		HB296x.670	D370		
C3500 Pickup		7.4	1990-1991	Drum	HB296x.670	D370		
C3500 Pickup		7.4	1990-2000	Drum	HB298x.787	D459		
C3500 Pickup		7.4	1992-1994	Disc	HB337x.791	D149	HB337x.791	D149
C3500 Pickup		7.4	1992-1997	Drum	HB296x.670	D370		
C3500 Pickup		7.4	1998-2000	Drum	HB296x.670	D370		
Camaro	Iroc-Z	5.0	1990-1990	w/Heavy Duty Brakes	HB111x.610	D412	HB112x.540	D413
Camaro	Iroc-Z	5.0	1990-1990	w/Standard Brakes	HB119x.594	D154	HB112x.540	D413
Camaro	Iroc-Z	5.7	1990-1990	w/Heavy Duty Brakes	HB111x.610	D412	HB112x.540	D413
Camaro	Iroc-Z	5.7	1990-1990	w/Standard Brakes	HB119x.594	D154	HB112x.540	D413
Camaro	LT	4.1	1977-1977		HB103x.590	D313		
Camaro	LT	5.0	1976-1977		HB103x.590	D313		
Camaro	LT	5.7	1976-1977		HB103x.590	D313		
Camaro	RS	3.1	1990-1992	w/Heavy Duty Brakes	HB111x.610	D412	HB112x.540	D413
Camaro	RS	3.1	1990-1992	w/Standard Brakes	HB119x.594	D154	HB112x.540	D413
Camaro	RS	3.8	1996-1997		HB217x.681	D623	HB112x.540	D413
Camaro	RS	5.0	1990-1992	w/Heavy Duty Brakes	HB111x.610	D412	HB112x.540	D413
Camaro	RS	5.0	1990-1992	w/Standard Brakes	HB119x.594	D154	HB112x.540	D413
Camaro	SS	5.7	1998-2002		HB249x.575	D749	HB250x.653	D750
Camaro	Z28	5.0	1991-1992	w/Heavy Duty Brakes	HB111x.610	D412	HB112x.540	D413
Camaro	Z28	5.0	1991-1992	w/Standard Brakes	HB119x.594	D154	HB112x.540	D413
Camaro	Z28	5.7	1972-1972		HB103x.590	D313		
Camaro	Z28	5.7	1991-1992	w/Heavy Duty Brakes	HB111x.610	D412	HB112x.540	D413
Camaro	Z28	5.7	1991-1992	w/Standard Brakes	HB119x.594	D154	HB112x.540	D413
Camaro	Z28	5.7	1993-1993		HB129x.681	D505	HB112x.540	D413
Camaro	Z28	5.7	1994-1997		HB217x.681	D623	HB112x.540	D413
Camaro	Z28	5.7	1998-2002		HB249x.575	D749	HB250x.653	D750
Camaro		2.5	1982-1986		HB119x.594	D154	HB119x.594	D154
Camaro		2.8	1982-1987		HB119x.594	D154	HB119x.594	D154
Camaro		2.8	1988-1988	w/Standard Brakes	HB119x.594	D154	HB119x.594	D154
Camaro		2.8	1988-1989	w/Heavy Duty Brakes	HB111x.610	D412	HB112x.540	D413
Camaro		2.8	1989-1989	w/Standard Brakes	HB119x.594	D154		
Camaro		3.4	1993-1993		HB129x.681	D505	HB112x.540	D413
Camaro		3.4	1994-1995		HB217x.681	D623	HB112x.540	D413
Camaro		3.8	1969-1969		HB103x.590	D313		
Camaro		3.8	1980-1981		HB103x.590	D313		
Camaro		3.8	1995-1997		HB217x.681	D623	HB112x.540	D413
Camaro		3.8	1998-2002		HB249x.575	D749	HB250x.653	D750
Camaro		4.1	1969-1979		HB103x.590	D313		

CODE Breakdown

HB 245 x .631

Insert Compound Code

Make/Model	Submodel	Engine (Liter)	Years	Note	FRONT		REAR	
					Hawk #	FMSI	Hawk #	FMSI
CHEVROLET CONT.								
Camaro		4.4	1980-1981		HB103x.590	D313		
Camaro		5.0	1969-1973		HB103x.590	D313		
Camaro		5.0	1976-1981		HB103x.590	D313		
Camaro		5.0	1982-1987		HB119x.594	D154	HB119x.594	D154
Camaro		5.0	1988-1988	w/Standard Brakes	HB119x.594	D154	HB119x.594	D154
Camaro		5.0	1988-1989	w/Heavy Duty Brakes	HB111x.610	D412	HB112x.540	D413
Camaro		5.0	1989-1989	w/Standard Brakes	HB119x.594	D154		
Camaro		5.4	1969-1969		HB103x.590	D313		
Camaro		5.7	1969-1981		HB103x.590	D313		
Camaro		5.7	1987-1987		HB119x.594	D154	HB119x.594	D154
Camaro		5.7	1988-1988	w/Standard Brakes	HB119x.594	D154	HB119x.594	D154
Camaro		5.7	1988-1989	w/Heavy Duty Brakes	HB111x.610	D412	HB112x.540	D413
Camaro		5.7	1989-1989	w/Standard Brakes	HB119x.594	D154		
Camaro		6.5	1969-1970		HB103x.590	D313		
Camaro		6.6	1970-1972		HB103x.590	D313		
Camaro		7.0	1969-1969		HB103x.590	D313		
Caprice	Classic	3.8	1980-1984		HB103x.590	D313		
Caprice	Classic	4.1	1977-1977		HB103x.590	D313		
Caprice	Classic	4.1	1979-1979		HB103x.590	D313		
Caprice	Classic	4.3	1985-1990		HB103x.590	D313		
Caprice	Classic	4.3	1993-1993		HB103x.590	D313		
Caprice	Classic	4.3	1994-1996	Except Police	HB103x.590	D313		
Caprice	Classic	4.3	1994-1996	Police	HB131x.595	D614		
Caprice	Classic	4.4	1980-1982		HB103x.590	D313		
Caprice	Classic	5.0	1977-1977		HB103x.590	D313		
Caprice	Classic	5.0	1979-1993		HB103x.590	D313		
Caprice	Classic	5.7	1973-1977		HB103x.590	D313		
Caprice	Classic	5.7	1979-1985		HB103x.590	D313		
Caprice	Classic	5.7	1991-1992		HB103x.590	D313		
Caprice	Classic	5.7	1994-1996	Except Police	HB103x.590	D313		
Caprice	Classic	5.7	1994-1996	Police	HB131x.595	D614		
Caprice	Classic	6.6	1973-1976		HB103x.590	D313		
Caprice	Classic	7.4	1973-1976		HB103x.590	D313		
Caprice	Classic Brougham	4.3	1987-1988		HB103x.590	D313		
Caprice	Classic Brougham	5.0	1987-1990		HB103x.590	D313		
Caprice	Classic LS	4.3	1994-1994		HB103x.590	D313		
Caprice	Classic LS	5.0	1993-1993		HB103x.590	D313		
Caprice	Classic LTZ	5.0	1991-1992		HB103x.590	D313		
Caprice	Classic LTZ	5.7	1991-1993		HB103x.590	D313		
Caprice	Estate	5.0	1977-1977		HB103x.590	D313		
Caprice	Estate	5.7	1973-1973		HB103x.590	D313		
Caprice	Estate	5.7	1977-1977		HB103x.590	D313		
Caprice	Estate	6.6	1973-1976		HB103x.590	D313		
Caprice	Estate	7.4	1973-1976		HB103x.590	D313		
Caprice	LS	5.7	1994-1994		HB103x.590	D313		
Caprice		4.1	1968-1969		HB103x.590	D313		
Caprice		4.1	1978-1978		HB103x.590	D313		
Caprice		4.3	1986-1990		HB103x.590	D313		
Caprice		4.3	1992-1992		HB103x.590	D313		
Caprice		5.0	1968-1968		HB103x.590	D313		
Caprice		5.0	1978-1978		HB103x.590	D313		
Caprice		5.0	1986-1992		HB103x.590	D313		
Caprice		5.4	1968-1969		HB103x.590	D313		

RACE COMPOUND CODES

DTC-70 - U | DTC-05 - H | MT-4 - L | DR-97 - J
 DTC-60 - G | HT-14 - V | Blue 9012 - E | HP Plus - N
 DTC-30 - W | HT-10 - S | Black - M

STREET COMPOUND CODES

HPS Performance Street - F | SuperDuty - P
 Performance Ceramic - Z
 LTS Light Truck & SUV - Y

Make/ Model	Submodel	Engine (Liter)	Years	Note	FRONT		REAR	
					Hawk #	FMSI	Hawk #	FMSI
CHEVROLET CONT.								
Caprice		5.7	1969-1972		HB103x.590	D313		
Caprice		5.7	1978-1978		HB103x.590	D313		
Caprice		5.7	1986-1993		HB103x.590	D313		
Caprice		5.7	1994-1994	Except Police	HB103x.590	D313		
Caprice		5.7	1994-1994	Police	HB131x.595	D614		
Caprice		6.5	1968-1969		HB103x.590	D313		
Caprice		6.6	1970-1972		HB103x.590	D313		
Caprice		7.0	1968-1969		HB103x.590	D313		
Caprice		7.4	1970-1972		HB103x.590	D313		
Cavalier	CL	2.0	1983-1983		HB400x.630	D159		
Cavalier	CS	2.0	1983-1987		HB400x.630	D159		
Cavalier	CS	2.8	1985-1985		HB400x.630	D159		
Cavalier	CS	2.8	1987-1987		HB400x.630	D159		
Cavalier	LS	2.2	1995-1998		HB390x.602	D506		
Cavalier	LS	2.2	1996-1998		HB393x.665	D914		
Cavalier	LS	2.3	1995-1995		HB390x.602	D506		
Cavalier	LS	2.4	1996-1998		HB390x.602	D506		
Cavalier	LS	2.4	1996-1998		HB393x.665	D914		
Cavalier	RS	2.0	1986-1988		HB400x.630	D159		
Cavalier	RS	2.2	1991-1991		HB400x.630	D159		
Cavalier	RS	2.2	1992-1994		HB390x.602	D506		
Cavalier	RS	2.2	1997-1998		HB390x.602	D506		
Cavalier	RS	2.2	1997-1998		HB393x.665	D914		
Cavalier	RS	2.8	1986-1988		HB400x.630	D159		
Cavalier	RS	3.1	1991-1991		HB400x.630	D159		
Cavalier	RS	3.1	1992-1994		HB390x.602	D506		
Cavalier	Type-10	2.0	1984-1985		HB400x.630	D159		
Cavalier	Type-10	2.8	1985-1985		HB400x.630	D159		
Cavalier	VL	2.0	1988-1988		HB400x.630	D159		
Cavalier	VL	2.2	1990-1991		HB400x.630	D159		
Cavalier	VL	2.2	1992-1994		HB390x.602	D506		
Cavalier	Z24	2.3	1995-1995		HB390x.602	D506		
Cavalier	Z24	2.4	1996-1998		HB390x.602	D506		
Cavalier	Z24	2.4	1996-1998		HB393x.665	D914		
Cavalier	Z24	2.8	1986-1989		HB400x.630	D159		
Cavalier	Z24	3.1	1990-1991		HB400x.630	D159		
Cavalier	Z24	3.1	1992-1994		HB390x.602	D506		
Cavalier		1.8	1982-1982		HB400x.630	D159		
Cavalier		2.0	1983-1989		HB400x.630	D159		
Cavalier		2.2	1990-1990		HB400x.630	D159		
Cavalier		2.2	1995-2005		HB390x.602	D506		
Cavalier		2.4	1999-2002		HB390x.602	D506		
Cavalier		2.8	1985-1985		HB400x.630	D159		
Cavalier		2.8	1987-1989		HB400x.630	D159		
Cavalier		3.1	1990-1990		HB400x.630	D159		
Celebrity		2.5	1982-1986		HB400x.630	D159		
Celebrity		2.5	1987-1989	w/Heavy Duty Brakes	HB396x.630	D215		
Celebrity		2.5	1987-1989	w/Standard Brakes	HB400x.630	D159		
Celebrity		2.5	1990-1990		HB396x.630	D215		
Celebrity		2.8	1982-1986		HB400x.630	D159		
Celebrity		2.8	1987-1989	w/Heavy Duty Brakes	HB396x.630	D215		
Celebrity		2.8	1987-1989	w/Standard Brakes	HB400x.630	D159		
Celebrity		3.1	1990-1990		HB396x.630	D215		

CODE Breakdown

HB 245 x .631

Insert Compound Code

Make/Model	Submodel	Engine (Liter)	Years	Note	FRONT		REAR	
					Hawk #	FMSI	Hawk #	FMSI
CHEVROLET CONT.								
Celebrity		4.3	1982-1982		HB400x.630	D159		
Celebrity		4.3	1983-1985		HB396x.630	D215		
Citation		2.5	1980-1985		HB400x.630	D159		
Citation		2.8	1980-1985		HB400x.630	D159		
Classic		2.2	2004-2005		HB425x.661	D727		
Cobalt	LS	2.2	2006-2008		HB517x.690	D956		
Cobalt	LT	2.2	2006-2008		HB517x.690	D956		
Cobalt	LTZ	2.2	2006-2007		HB517x.690	D956		
Cobalt	SS	2.0	2005-2007		HB524x.740	D1028	HB525x.540	D1033
Cobalt	SS	2.4	2006-2007		HB524x.740	D1028	HB525x.540	D1033
Cobalt		2.2	2005-2005		HB517x.690	D956		
Colorado	LS	2.8	2006-2006		HB554x.643	D1039		
Colorado	LS	2.9	2007-2008		HB554x.643	D1039		
Colorado	LS	3.7	2007-2008		HB554x.643	D1039		
Colorado	LT	2.8	2006-2006		HB554x.643	D1039		
Colorado	LT	2.9	2007-2008		HB554x.643	D1039		
Colorado	LT	3.5	2006-2006		HB554x.643	D1039		
Colorado	LT	3.7	2007-2008		HB554x.643	D1039		
Colorado	Sport	2.8	2005-2005		HB554x.643	D1039		
Colorado	Sport	3.5	2005-2005		HB554x.643	D1039		
Colorado	Sport LS	2.8	2005-2005		HB554x.643	D1039		
Colorado	Sport LS	3.5	2005-2005		HB554x.643	D1039		
Colorado	WT	2.8	2006-2006		HB554x.643	D1039		
Colorado	WT	2.9	2007-2008		HB554x.643	D1039		
Colorado	WT	3.5	2006-2006		HB554x.643	D1039		
Colorado	WT	3.7	2008-2008		HB554x.643	D1039		
Colorado	Z71	2.8	2005-2005		HB554x.643	D1039		
Colorado	Z71	3.5	2005-2005		HB554x.643	D1039		
Colorado	Z71 LS	2.8	2005-2005		HB554x.643	D1039		
Colorado	Z71 LS	3.5	2005-2005		HB554x.643	D1039		
Colorado	Z85	2.8	2005-2005		HB554x.643	D1039		
Colorado	Z85	3.5	2005-2005		HB554x.643	D1039		
Colorado	Z85 LS	2.8	2005-2005		HB554x.643	D1039		
Colorado	Z85 LS	3.5	2005-2005		HB554x.643	D1039		
Colorado		2.8	2004-2004		HB554x.643	D1039		
Colorado		3.5	2004-2004		HB554x.643	D1039		
Corsica	LT	2.2	1990-1991		HB400x.630	D159		
Corsica	LT	2.2	1992-1993		HB390x.602	D506		
Corsica	LT	3.1	1990-1991		HB400x.630	D159		
Corsica	LT	3.1	1992-1993		HB390x.602	D506		
Corsica	LTZ	2.8	1989-1989		HB400x.630	D159		
Corsica	LTZ	3.1	1990-1990		HB400x.630	D159		
Corsica		2.0	1987-1989		HB400x.630	D159		
Corsica		2.2	1994-1996		HB390x.602	D506		
Corsica		2.8	1987-1989		HB400x.630	D159		
Corsica		3.1	1994-1996		HB390x.602	D506		
Corvette	427 LMT EDT. Z06	7.0	2008-2008		HB247x.575	D731	HB248x.650	D732
Corvette	Z06	5.7	2001-2004		HB247x.575	D731	HB248x.650	D732
Corvette	Z06	7.0	2006-2008		HB531x.570	D1185	HB532x.570	D1185
Corvette	ZR-1	5.7	1990-1995		HB111x.610	D412	HB112x.540	D413
Corvette		5.0	1980-1980		HB126x.505	D8	HB126x.505	D8
Corvette		5.4	1966-1968		HB126x.505	D8	HB126x.505	D8
Corvette		5.7	1969-1982		HB126x.505	D8	HB126x.505	D8

RACE COMPOUND CODES

DTC-70 - U | DTC-05 - H | MT-4 - L | DR-97 - J
 DTC-60 - G | HT-14 - V | Blue 9012 - E | HP Plus - N
 DTC-30 - W | HT-10 - S | Black - M

STREET COMPOUND CODES

HPS Performance Street - F | SuperDuty - P
 Performance Ceramic - Z
 LTS Light Truck & SUV - Y

Make/Model	Submodel	Engine		Note	FRONT		REAR	
		(Liter)	Years		Hawk #	FMSI	Hawk #	FMSI
CHEVROLET CONT.								
Corvette		5.7	1985-1987		HB173x.570	D294	HB112x.540	D413
Corvette		5.7	1988-1996		HB111x.610	D412	HB112x.540	D413
Corvette		5.7	1997-2004		HB247x.575	D731	HB248x.650	D732
Corvette		6.0	2005-2007		HB247x.575	D731	HB248x.650	D732
Corvette		6.2	2008-2008		HB247x.575	D731	HB248x.650	D732
Corvette		7.0	1966-1969		HB126x.505	D8	HB126x.505	D8
Corvette		7.4	1970-1974		HB126x.505	D8	HB126x.505	D8
El Camino	Classic	4.1	1977-1977		HB103x.590	D313		
El Camino	Classic	5.0	1977-1977		HB103x.590	D313		
El Camino	Classic	5.7	1977-1977		HB103x.590	D313		
El Camino	Custom	3.8	1968-1969		HB103x.590	D313		
El Camino	Custom	4.1	1968-1973		HB103x.590	D313		
El Camino	Custom	5.0	1968-1972		HB103x.590	D313		
El Camino	Custom	5.4	1968-1968		HB103x.590	D313		
El Camino	Custom	5.7	1969-1974		HB103x.590	D313		
El Camino	Custom	6.5	1969-1969		HB103x.590	D313		
El Camino	Custom	6.6	1970-1972		HB103x.590	D313		
El Camino	Custom	6.6	1974-1974		HB103x.590	D313		
El Camino	Custom	7.4	1970-1974		HB103x.590	D313		
El Camino		3.3	1978-1979		HB119x.594	D154		
El Camino		3.8	1966-1969		HB103x.590	D313		
El Camino		3.8	1978-1984		HB119x.594	D154		
El Camino		4.1	1967-1977		HB103x.590	D313		
El Camino		4.3	1985-1987		HB119x.594	D154		
El Camino		4.4	1979-1982		HB119x.594	D154		
El Camino		4.6	1966-1967		HB103x.590	D313		
El Camino		5.0	1968-1973		HB103x.590	D313		
El Camino		5.0	1976-1977		HB103x.590	D313		
El Camino		5.0	1978-1987		HB119x.594	D154		
El Camino		5.4	1966-1968		HB103x.590	D313		
El Camino		5.7	1969-1977		HB103x.590	D313		
El Camino		5.7	1978-1979		HB119x.594	D154		
El Camino		5.7	1983-1984		HB119x.594	D154		
El Camino		6.5	1966-1970		HB103x.590	D313		
El Camino		6.6	1970-1972		HB103x.590	D313		
El Camino		6.6	1974-1976		HB103x.590	D313		
El Camino		7.4	1970-1970		HB103x.590	D313		
El Camino		7.4	1973-1975		HB103x.590	D313		
Equinox	LS	3.4	2005-2006		HB472x.650	D833		
Equinox	LT	3.4	2005-2006		HB472x.650	D833		
Express 1500	LS	5.3	2008-2008		HB323x.724	D785	HB494x.670	D974
Express 1500	LT	5.3	2008-2008		HB323x.724	D785	HB494x.670	D974
Express 1500		4.3	1999-2002		HB332x.654	D369		
Express 1500		4.3	2008-2008		HB323x.724	D785	HB494x.670	D974
Express 1500		5.0	1999-2002		HB332x.654	D369		
Express 1500		5.3	2008-2008		HB323x.724	D785	HB494x.670	D974
Express 1500		5.7	1999-2002		HB332x.654	D369		
Express 2500	LS	6.0	2008-2008		HB322x.717	D784	HB494x.670	D974
Express 2500	LT	6.0	2008-2008		HB322x.717	D784	HB494x.670	D974
Express 2500		4.3	1999-2002		HB332x.654	D369		
Express 2500		4.3	2003-2004		HB322x.717	D784		
Express 2500		4.3	2003-2005		HB323x.724	D785	HB494x.670	D974
Express 2500		4.8	2003-2004		HB322x.717	D784		

CODE Breakdown

HB 245 x .631

Insert Compound Code

Make/Model	Submodel	Engine (Liter)	Years	Note	FRONT		REAR	
					Hawk #	FMSI	Hawk #	FMSI
CHEVROLET CONT.								
Express 2500		4.8	2003-2005		HB323x.724	D785		
Express 2500		4.8	2008-2008		HB322x.717	D784	HB494x.670	D974
Express 2500		5.0	1999-2002		HB332x.654	D369		
Express 2500		5.3	2003-2004		HB322x.717	D784		
Express 2500		5.3	2003-2005		HB323x.724	D785	HB494x.670	D974
Express 2500		5.7	1999-2002		HB332x.654	D369		
Express 2500		6.0	2003-2004		HB322x.717	D784		
Express 2500		6.0	2003-2005		HB323x.724	D785		
Express 2500		6.0	2008-2008		HB322x.717	D784	HB494x.670	D974
Express 2500		6.5	1999-2002		HB332x.654	D369		
Express 2500		6.6	2008-2008		HB322x.717	D784	HB494x.670	D974
Express 3500	LS	6.0	2006-2006	Dual Rear Wheels, Single Rear Wheels	HB322x.717	D784		
Express 3500	LS	6.0	2008-2008	Dual Rear Wheels	HB322x.717	D784	HB591x.760	D989
Express 3500	LT	6.0	2006-2006	Dual Rear Wheels, Single Rear Wheels	HB322x.717	D784		
Express 3500	LT	6.0	2008-2008	Dual Rear Wheels	HB322x.717	D784	HB591x.760	D989
Express 3500		4.8	2005-2008	Dual Rear Wheels	HB322x.717	D784	HB591x.760	D989
Express 3500		5.7	1999-2002		HB298x.787	D459		
Express 3500		6.0	2003-2004		HB322x.717	D784		
Express 3500		6.0	2005-2008	Dual Rear Wheels	HB322x.717	D784	HB591x.760	D989
Express 3500		6.5	1999-2002		HB298x.787	D459		
Express 3500		6.6	2006-2008	Dual Rear Wheels	HB322x.717	D784	HB591x.760	D989
Express 3500		7.4	1999-2000		HB298x.787	D459		
Express 3500		8.1	2001-2002		HB298x.787	D459		
G10 Van	SportVan	4.1	1970-1984		HB103x.590	D313		
G10 Van	SportVan	4.3	1985-1991		HB103x.590	D313		
G10 Van	SportVan	5.0	1970-1973		HB103x.590	D313		
G10 Van	SportVan	5.0	1977-1991		HB103x.590	D313		
G10 Van	SportVan	5.7	1970-1991		HB103x.590	D313		
G10 Van	SportVan	6.6	1976-1976		HB103x.590	D313		
G10 Van		4.1	1970-1984		HB103x.590	D313		
G10 Van		4.3	1985-1991		HB103x.590	D313		
G10 Van		5.0	1970-1973		HB103x.590	D313		
G10 Van		5.0	1977-1991		HB103x.590	D313		
G10 Van		5.7	1970-1980		HB103x.590	D313		
G10 Van		6.6	1976-1976		HB103x.590	D313		
G10 Van		7.4	1973-1974		HB103x.590	D313		
G20 Van	SportVan	4.1	1970-1974		HB103x.590	D313		
G20 Van	SportVan	4.1	1976-1976		HB103x.590	D313		
G20 Van	SportVan	4.1	1978-1984		HB103x.590	D313		
G20 Van	SportVan	4.3	1985-1991		HB103x.590	D313		
G20 Van	SportVan	4.8	1975-1978		HB103x.590	D313		
G20 Van	SportVan	5.0	1970-1970		HB103x.590	D313		
G20 Van	SportVan	5.0	1977-1978		HB103x.590	D313		
G20 Van	SportVan	5.0	1981-1991		HB103x.590	D313		
G20 Van	SportVan	5.7	1970-1991		HB103x.590	D313		
G20 Van	SportVan	6.2	1983-1991		HB103x.590	D313		
G20 Van	SportVan	6.6	1975-1980		HB103x.590	D313		
G20 Van		4.1	1970-1984		HB103x.590	D313		
G20 Van		4.3	1985-1991		HB103x.590	D313		
G20 Van		4.8	1971-1971		HB103x.590	D313		
G20 Van		4.8	1973-1980		HB103x.590	D313		
G20 Van		5.0	1970-1970		HB103x.590	D313		
G20 Van		5.0	1977-1991		HB103x.590	D313		

RACE COMPOUND CODES

DTC-70 - U	DTC-05 - H	MT-4 - L	DR-97 - J
DTC-60 - G	HT-14 - V	Blue 9012 - E	HP Plus - N
DTC-30 - W	HT-10 - S	Black - M	

STREET COMPOUND CODES

HPS Performance Street - F	SuperDuty - P
Performance Ceramic - Z	
LTS Light Truck & SUV - Y	

Make/Model	Submodel	Engine (Liter)	Years	Note	FRONT		REAR	
					Hawk #	FMSI	Hawk #	FMSI
CHEVROLET CONT.								
G20 Van		5.7	1970-1982		HB103x.590	D313		
G20 Van		5.7	1984-1991		HB103x.590	D313		
G20 Van		6.2	1983-1991		HB103x.590	D313		
G20 Van		6.6	1975-1980		HB103x.590	D313		
G20 Van		7.4	1973-1974		HB103x.590	D313		
G20 Van		7.4	1976-1976		HB103x.590	D313		
G30 Van	SportVan	4.1	1971-1974		HB103x.590	D313		
G30 Van	SportVan	4.8	1975-1978		HB103x.590	D313		
G30 Van	SportVan	5.7	1971-1978		HB103x.590	D313		
G30 Van	SportVan	5.7	1979-1979	w/13 in. Drums	HB131x.595	D614		
G30 Van	SportVan	5.7	1979-1980	w/11 in. Drums	HB103x.590	D313		
G30 Van	SportVan	5.7	1980-1984	w/13 x 2.5 in. Drums	HB131x.595	D614		
G30 Van	SportVan	5.7	1981-1982	w/11 in. Rotors	HB103x.590	D313		
G30 Van	SportVan	5.7	1983-1984	w/11 in. Drums	HB103x.590	D313		
G30 Van	SportVan	5.7	1985-1985		HB103x.590	D313		
G30 Van	SportVan	5.7	1985-1993		HB131x.595	D614		
G30 Van	SportVan	5.7	1996-1996		HB298x.787	D459		
G30 Van	SportVan	6.2	1983-1984	w/11 in. Drums	HB103x.590	D313		
G30 Van	SportVan	6.2	1983-1984	w/13 x 2.5 in. Drums	HB131x.595	D614		
G30 Van	SportVan	6.2	1985-1993		HB131x.595	D614		
G30 Van	SportVan	6.6	1975-1978		HB103x.590	D313		
G30 Van	SportVan	6.6	1979-1979	w/13 in. Drums	HB131x.595	D614		
G30 Van	SportVan	6.6	1979-1980	w/11 in. Drums	HB103x.590	D313		
G30 Van	SportVan	6.6	1980-1980	w/13 x 2.5 in. Drums	HB131x.595	D614		
G30 Van	SportVan	7.4	1988-1993		HB131x.595	D614		
G30 Van		4.1	1971-1974		HB103x.590	D313		
G30 Van		4.1	1976-1976	w/13 in. Drums	HB103x.590	D313		
G30 Van		4.1	1976-1976	w/11 in. Drums	HB337x.791	D149		
G30 Van		4.1	1978-1978	w/13 in. Drums	HB103x.590	D313		
G30 Van		4.1	1978-1978	w/11 in. Drums	HB337x.791	D149		
G30 Van		4.1	1979-1979	w/11 in. Drums	HB103x.590	D313		
G30 Van		4.1	1979-1979	w/13 x 2.5 in. Drums	HB131x.595	D614		
G30 Van		4.1	1979-1979	w/13 x 3.5 in. Drums	HB337x.791	D149		
G30 Van		4.1	1981-1984	w/11 in. Drums	HB103x.590	D313		
G30 Van		4.1	1981-1984	w/13 x 2.5 in. Drums	HB131x.595	D614		
G30 Van		4.1	1981-1984	w/13 x 3.5 in. Drums	HB337x.791	D149		
G30 Van		4.3	1985-1993	w/13 x 2.5 in. Drums	HB131x.595	D614		
G30 Van		4.3	1985-1993	w/13 x 3.5 in. Drums	HB337x.791	D149		
G30 Van		4.3	1994-1995		HB337x.791	D149		
G30 Van		4.8	1971-1972		HB103x.590	D313		
G30 Van		4.8	1974-1975		HB103x.590	D313		
G30 Van		4.8	1976-1978	w/13 in. Drums	HB103x.590	D313		
G30 Van		4.8	1976-1978	w/11 in. Drums	HB337x.791	D149		
G30 Van		4.8	1979-1979	w/11 in. Drums	HB103x.590	D313		
G30 Van		4.8	1979-1979	w/13 x 2.5 in. Drums	HB131x.595	D614		
G30 Van		4.8	1979-1979	w/13 x 3.5 in. Drums	HB337x.791	D149		
G30 Van		5.0	1978-1978	w/13 in. Drums	HB103x.590	D313		
G30 Van		5.0	1978-1978	w/11 in. Drums	HB337x.791	D149		
G30 Van		5.0	1979-1979	w/11 in. Drums	HB103x.590	D313		
G30 Van		5.0	1979-1979	w/13 x 2.5 in. Drums	HB131x.595	D614		
G30 Van		5.0	1979-1979	w/13 x 3.5 in. Drums	HB337x.791	D149		
G30 Van		5.0	1982-1982	w/11 in. Drums	HB103x.590	D313		
G30 Van		5.0	1982-1982	w/13 x 2.5 in. Drums	HB131x.595	D614		

CODE Breakdown

HB 245 x .631

Insert Compound Code

Make/Model	Submodel	Engine (Liter)	Years	Note	FRONT		REAR	
					Hawk #	FMSI	Hawk #	FMSI
CHEVROLET CONT.								
G30 Van		5.0	1982-1982	w/13 x 3.5 in. Drums	HB337x.791	D149		
G30 Van		5.0	1985-1985	w/13 x 2.5 in. Drums	HB131x.595	D614		
G30 Van		5.0	1985-1985	w/13 x 3.5 in. Drums	HB337x.791	D149		
G30 Van		5.7	1971-1975		HB103x.590	D313		
G30 Van		5.7	1976-1978	w/13 in. Drums	HB103x.590	D313		
G30 Van		5.7	1976-1978	w/11 in. Drums	HB337x.791	D149		
G30 Van		5.7	1979-1984	w/11 in. Drums	HB103x.590	D313		
G30 Van		5.7	1979-1993	w/13 x 2.5 in. Drums	HB131x.595	D614		
G30 Van		5.7	1979-1993	w/13 x 3.5 in. Drums	HB337x.791	D149		
G30 Van		5.7	1994-1995		HB337x.791	D149		
G30 Van		5.7	1996-1996		HB298x.787	D459		
G30 Van		6.2	1983-1984	w/11 in. Drums	HB103x.590	D313		
G30 Van		6.2	1983-1993	w/13 x 2.5 in. Drums	HB131x.595	D614		
G30 Van		6.2	1983-1993	w/13 x 3.5 in. Drums	HB337x.791	D149		
G30 Van		6.5	1994-1995		HB337x.791	D149		
G30 Van		6.6	1975-1975		HB103x.590	D313		
G30 Van		6.6	1976-1978	w/13 in. Drums	HB103x.590	D313		
G30 Van		6.6	1976-1978	w/11 in. Drums	HB337x.791	D149		
G30 Van		6.6	1979-1980	w/11 in. Drums	HB103x.590	D313		
G30 Van		6.6	1979-1980	w/13 x 2.5 in. Drums	HB131x.595	D614		
G30 Van		6.6	1979-1980	w/13 x 3.5 in. Drums	HB337x.791	D149		
G30 Van		7.4	1973-1975		HB103x.590	D313		
G30 Van		7.4	1976-1976	w/13 in. Drums	HB103x.590	D313		
G30 Van		7.4	1976-1976	w/11 in. Drums	HB337x.791	D149		
G30 Van		7.4	1988-1993	w/13 x 2.5 in. Drums	HB131x.595	D614		
G30 Van		7.4	1988-1993	w/13 x 3.5 in. Drums	HB337x.791	D149		
G30 Van		7.4	1994-1995		HB337x.791	D149		
HHR	LS	2.2	2008-2008		HB524x.740	D1028		
HHR	LS Panel	2.2	2008-2008		HB524x.740	D1028		
HHR	LT	2.2	2008-2008		HB524x.740	D1028		
HHR	LT	2.4	2008-2008		HB524x.740	D1028		
HHR	LT Panel	2.2	2008-2008		HB524x.740	D1028		
HHR	LT Panel	2.4	2008-2008		HB524x.740	D1028		
HHR	SS	2.0	2008-2009		HB524x.740	D1028	HB525x.540	D1033
HHR	SS Panel	2.0	2009-2009		HB524x.740	D1028	HB525x.540	D1033
Impala	Custom	4.1	1977-1977		HB103x.590	D313		
Impala	Custom	5.0	1977-1977		HB103x.590	D313		
Impala	Custom	5.7	1976-1977		HB103x.590	D313		
Impala	Custom	6.6	1976-1976		HB103x.590	D313		
Impala	Custom	7.4	1976-1976		HB103x.590	D313		
Impala	LS	3.8	2000-2004		HB360x.670	D699	HB359x.543	D814
Impala	LS	3.8	2005-2005		HB536x.704	D1076	HB359x.543	D814
Impala	SS	3.8	2004-2004		HB360x.670	D699	HB359x.543	D814
Impala	SS	3.8	2005-2005		HB536x.704	D1076		
Impala		3.4	2000-2004		HB360x.670	D699	HB359x.543	D814
Impala		3.4	2005-2005		HB536x.704	D1076		
Impala		3.8	1980-1984		HB103x.590	D313		
Impala		3.8	2000-2004		HB360x.670	D699	HB359x.543	D814
Impala		3.8	2005-2005		HB536x.704	D1076		
Impala		4.1	1968-1973		HB103x.590	D313		
Impala		4.1	1977-1979		HB103x.590	D313		
Impala		4.3	1985-1985		HB103x.590	D313		
Impala		4.4	1980-1982		HB103x.590	D313		

RACE COMPOUND CODES

DTC-70 - U | DTC-05 - H | MT-4 - L | DR-97 - J
 DTC-60 - G | HT-14 - V | Blue 9012 - E | HP Plus - N
 DTC-30 - W | HT-10 - S | Black - M

STREET COMPOUND CODES

HPS Performance Street - F | SuperDuty - P
 Performance Ceramic - Z
 LTS Light Truck & SUV - Y

Make/ Model	Submodel	Engine (Liter)	Years	Note	FRONT		REAR	
					Hawk #	FMSI	Hawk #	FMSI
CHEVROLET CONT.								
Impala		5.0	1968-1968		HB103x.590	D313		
Impala		5.0	1977-1985		HB103x.590	D313		
Impala		5.4	1968-1969		HB103x.590	D313		
Impala		5.7	1969-1985		HB103x.590	D313		
Impala		6.5	1968-1969		HB103x.590	D313		
Impala		6.6	1970-1976		HB103x.590	D313		
Impala		7.0	1968-1969		HB103x.590	D313		
Impala		7.4	1970-1976		HB103x.590	D313		
Impala SS		5.7	1994-1996		HB131x.595	D614		
K10 Suburban		4.1	1970-1980		HB103x.590	D313		
K10 Suburban		4.8	1970-1970		HB103x.590	D313		
K10 Suburban		5.0	1970-1973		HB103x.590	D313		
K10 Suburban		5.0	1976-1986		HB103x.590	D313		
K10 Suburban		5.7	1970-1986		HB103x.590	D313		
K10 Suburban		6.2	1982-1986		HB103x.590	D313		
K10 Suburban		6.6	1970-1972		HB103x.590	D313		
K10 Suburban		6.6	1975-1979		HB103x.590	D313		
K1500 Pickup		4.3	1988-1991	Extended Cab	HB332x.654	D369		
K1500 Pickup		4.3	1988-1991	Regular Cab	HB356x.654	D368		
K1500 Pickup		4.3	1992-1998		HB332x.654	D369		
K1500 Pickup		5.0	1988-1991	Extended Cab	HB332x.654	D369		
K1500 Pickup		5.0	1988-1991	Regular Cab	HB356x.654	D368		
K1500 Pickup		5.0	1992-1999		HB332x.654	D369		
K1500 Pickup		5.7	1988-1991	Extended Cab	HB332x.654	D369		
K1500 Pickup		5.7	1988-1991	Regular Cab	HB356x.654	D368		
K1500 Pickup		5.7	1992-1999		HB332x.654	D369		
K1500 Pickup		6.2	1988-1991	Extended Cab	HB332x.654	D369		
K1500 Pickup		6.2	1988-1991	Regular Cab	HB356x.654	D368		
K1500 Pickup		6.2	1992-1993		HB332x.654	D369		
K1500 Pickup		6.5	1994-1998		HB332x.654	D369		
K1500 Suburban		5.7	1995-1999		HB332x.654	D369		
K1500 Suburban		6.5	1995-1999		HB332x.654	D369		
K20 Pickup		4.1	1979-1980	w/13 in. Drums	HB131x.595	D614		
K20 Pickup		4.3	1985-1985	w/13 in. Drums	HB131x.595	D614		
K20 Pickup		4.8	1979-1985	w/13 in. Drums	HB131x.595	D614		
K20 Pickup		4.8	1986-1986		HB131x.595	D614		
K20 Pickup		5.0	1980-1980	w/13 in. Drums	HB131x.595	D614		
K20 Pickup		5.0	1985-1985	w/13 in. Drums	HB131x.595	D614		
K20 Pickup		5.7	1979-1985	w/13 in. Drums	HB131x.595	D614		
K20 Pickup		5.7	1986-1986		HB131x.595	D614		
K20 Pickup		6.2	1982-1985	w/13 in. Drums	HB131x.595	D614		
K20 Pickup		6.2	1986-1986		HB131x.595	D614		
K20 Pickup		6.6	1979-1980	w/13 in. Drums	HB131x.595	D614		
K20 Pickup		7.4	1980-1980	w/13 in. Drums	HB131x.595	D614		
K20 Suburban		4.8	1979-1982	w/11 in. Drums	HB103x.590	D313		
K20 Suburban		4.8	1979-1982	w/13 in. Drums	HB131x.595	D614		
K20 Suburban		5.0	1985-1986		HB131x.595	D614		
K20 Suburban		5.7	1979-1984	w/11 in. Drums	HB103x.590	D313		
K20 Suburban		5.7	1979-1984	w/13 in. Drums	HB131x.595	D614		
K20 Suburban		5.7	1985-1986		HB131x.595	D614		
K20 Suburban		6.2	1982-1984	w/11 in. Drums	HB103x.590	D313		
K20 Suburban		6.2	1982-1984	w/13 in. Drums	HB131x.595	D614		
K20 Suburban		6.2	1985-1986		HB131x.595	D614		

CODE Breakdown

HB 245 x .631

Insert Compound Code

Make/Model	Submodel	Engine (Liter)	Years	Note	FRONT		REAR	
					Hawk #	FMSI	Hawk #	FMSI
CHEVROLET CONT.								
K20 Suburban		6.6	1979-1980	w/11 in. Drums	HB103x.590	D313		
K20 Suburban		6.6	1979-1980	w/13 in. Drums	HB131x.595	D614		
K20 Suburban		7.4	1985-1985		HB131x.595	D614		
K2500 Pickup		4.3	1988-1995	w/13 in. Drums	HB296x.670	D370		
K2500 Pickup		4.3	1988-1995	w/11 in. Drums	HB332x.654	D369		
K2500 Pickup		5.0	1988-1998	w/13 in. Drums	HB296x.670	D370		
K2500 Pickup		5.0	1988-1998	w/11 in. Drums	HB332x.654	D369		
K2500 Pickup		5.7	1988-2000	w/13 in. Drums	HB296x.670	D370		
K2500 Pickup		5.7	1988-2000	w/11 in. Drums	HB332x.654	D369		
K2500 Pickup		6.2	1988-1993	w/13 in. Drums	HB296x.670	D370		
K2500 Pickup		6.2	1988-1993	w/11 in. Drums	HB332x.654	D369		
K2500 Pickup		6.5	1992-2000	w/13 in. Drums	HB296x.670	D370		
K2500 Pickup		6.5	1992-2000	w/11 in. Drums	HB332x.654	D369		
K2500 Pickup		7.4	1991-2000	w/13 in. Drums	HB296x.670	D370		
K2500 Pickup		7.4	1991-2000	w/11 in. Drums	HB332x.654	D369		
K2500 Suburban		5.7	1992-1999		HB296x.670	D370		
K2500 Suburban		5.7	1992-1999		HB332x.654	D369		
K2500 Suburban		6.5	1994-1999		HB296x.670	D370		
K2500 Suburban		6.5	1994-1999		HB332x.654	D369		
K2500 Suburban		7.4	1992-1999		HB296x.670	D370		
K2500 Suburban		7.4	1992-1999		HB332x.654	D369		
K30 Pickup		4.8	1979-1986		HB337x.791	D149		
K30 Pickup		5.7	1979-1986		HB337x.791	D149		
K30 Pickup		6.2	1982-1986		HB337x.791	D149		
K30 Pickup		6.6	1979-1980		HB337x.791	D149		
K30 Pickup		7.4	1980-1986		HB337x.791	D149		
K3500 Pickup		5.7	1988-1989		HB296x.670	D370		
K3500 Pickup		5.7	1990-2000	Single Rear Wheels	HB296x.670	D370		
K3500 Pickup		5.7	1990-2000	Dual Rear Wheels	HB298x.787	D459		
K3500 Pickup		6.2	1988-1989		HB296x.670	D370		
K3500 Pickup		6.2	1990-1993	Single Rear Wheels	HB296x.670	D370		
K3500 Pickup		6.2	1990-1993	Dual Rear Wheels	HB298x.787	D459		
K3500 Pickup		6.5	1992-2000	Single Rear Wheels	HB296x.670	D370		
K3500 Pickup		6.5	1992-2000	Dual Rear Wheels	HB298x.787	D459		
K3500 Pickup		7.4	1988-1989		HB296x.670	D370		
K3500 Pickup		7.4	1990-2000	Single Rear Wheels	HB296x.670	D370		
K3500 Pickup		7.4	1990-2000	Dual Rear Wheels	HB298x.787	D459		
Kodiak	C4500	6.0	1992-1996		HB251x1.14	D225	HB251x1.14	D225
Kodiak	C4500	7.0	1992-1996		HB251x1.14	D225	HB251x1.14	D225
Kodiak	C5500	6.0	1992-1996		HB251x1.14	D225	HB251x1.14	D225
Kodiak	C5500	7.0	1992-1996		HB251x1.14	D225	HB251x1.14	D225
Laguna	Estate	5.7	1973-1973		HB103x.590	D313		
Laguna	Estate	7.4	1973-1973		HB103x.590	D313		
Laguna		5.0	1976-1976		HB103x.590	D313		
Laguna		5.7	1973-1976		HB103x.590	D313		
Laguna		6.6	1974-1976		HB103x.590	D313		
Laguna		7.4	1973-1974		HB103x.590	D313		
Lumina	Euro	3.1	1990-1993		HB232x.681	D376	HB405x.543	D377
Lumina	Euro	3.1	1994-1994		HB232x.681	D376		
Lumina	Euro	3.4	1992-1993		HB232x.681	D376	HB405x.543	D377
Lumina	Euro	3.4	1994-1994		HB232x.681	D376		
Lumina	LS	3.1	1995-1997		HB232x.681	D376	HB359x.543	D814
Lumina	LS	3.4	1995-1996		HB232x.681	D376	HB359x.543	D814

RACE COMPOUND CODES

DTC-70 - U | DTC-05 - H | MT-4 - L | DR-97 - J
 DTC-60 - G | HT-14 - V | Blue 9012 - E | HP Plus - N
 DTC-30 - W | HT-10 - S | Black - M

STREET COMPOUND CODES

HPS Performance Street - F | SuperDuty - P
 Performance Ceramic - Z
 LTS Light Truck & SUV - Y

Make/Model	Submodel	Engine		Note	FRONT		REAR	
		(Liter)	Years		Hawk #	FMSI	Hawk #	FMSI
CHEVROLET CONT.								
Lumina	LTZ	3.1	1997-1998		HB232x.681	D376	HB359x.543	D814
Lumina	LTZ	3.4	1997-1997		HB232x.681	D376	HB359x.543	D814
Lumina	LTZ	3.8	1998-1998		HB232x.681	D376	HB359x.543	D814
Lumina	Z34	3.4	1991-1993		HB232x.681	D376	HB405x.543	D377
Lumina	Z34	3.4	1994-1994		HB232x.681	D376		
Lumina		2.2	1993-1993		HB232x.681	D376	HB405x.543	D377
Lumina		2.5	1990-1992		HB232x.681	D376	HB405x.543	D377
Lumina		3.1	1990-1993		HB232x.681	D376	HB405x.543	D377
Lumina		3.1	1998-1999		HB232x.681	D376	HB359x.543	D814
Lumina		3.8	1999-1999		HB232x.681	D376	HB359x.543	D814
Lumina APV		3.1	1990-1991		HB396x.630	D215		
Lumina APV		3.1	1992-1993		HB129x.681	D505		
Lumina APV		3.1	1994-1995		HB217x.681	D623		
Lumina APV		3.4	1996-1996		HB217x.681	D623		
Lumina APV		3.8	1992-1993		HB129x.681	D505		
Lumina APV		3.8	1994-1995		HB217x.681	D623		
Malibu	Classic	3.3	1978-1979		HB119x.594	D154		
Malibu	Classic	3.8	1978-1982		HB119x.594	D154		
Malibu	Classic	4.1	1974-1977		HB103x.590	D313		
Malibu	Classic	4.3	1982-1982		HB119x.594	D154		
Malibu	Classic	4.4	1979-1982		HB119x.594	D154		
Malibu	Classic	5.0	1976-1977		HB103x.590	D313		
Malibu	Classic	5.0	1978-1982		HB119x.594	D154		
Malibu	Classic	5.7	1974-1977		HB103x.590	D313		
Malibu	Classic	5.7	1978-1979		HB119x.594	D154		
Malibu	Classic	5.7	1982-1982		HB119x.594	D154		
Malibu	Classic	6.6	1974-1976		HB103x.590	D313		
Malibu	Classic	7.4	1974-1975		HB103x.590	D313		
Malibu	Estate	5.0	1973-1973		HB103x.590	D313		
Malibu	Estate	5.7	1973-1976		HB103x.590	D313		
Malibu	Estate	6.6	1974-1976		HB103x.590	D313		
Malibu	Estate	7.4	1973-1974		HB103x.590	D313		
Malibu	LS	2.2	2006-2006		HB524x.740	D1028	HB525x.540	D1033
Malibu	LS	3.1	1997-1998		HB425x.661	D727		
Malibu	LS	3.1	2000-2003		HB425x.661	D727		
Malibu	LS	3.5	2004-2005		HB524x.740	D1028	HB525x.540	D1033
Malibu	LT	2.2	2006-2006		HB524x.740	D1028	HB525x.540	D1033
Malibu	LT	3.5	2004-2006		HB524x.740	D1028	HB525x.540	D1033
Malibu	LTZ	3.5	2006-2006		HB524x.740	D1028	HB525x.540	D1033
Malibu	Maxx	3.5	2004-2004		HB524x.740	D1028	HB525x.540	D1033
Malibu	Maxx LS	3.5	2005-2006		HB524x.740	D1028	HB525x.540	D1033
Malibu	Maxx LT	3.5	2005-2006		HB524x.740	D1028	HB525x.540	D1033
Malibu	Maxx LTZ	3.5	2006-2006		HB524x.740	D1028	HB525x.540	D1033
Malibu	Maxx SS	3.9	2006-2006		HB524x.740	D1028	HB525x.540	D1033
Malibu	SS	3.9	2006-2006		HB524x.740	D1028	HB525x.540	D1033
Malibu		2.2	2004-2005		HB524x.740	D1028	HB525x.540	D1033
Malibu		2.4	1997-1999		HB425x.661	D727		
Malibu		3.1	1997-2003		HB425x.661	D727		
Malibu		3.2	1966-1966		HB103x.590	D313		
Malibu		3.3	1978-1979		HB119x.594	D154		
Malibu		3.8	1966-1967		HB103x.590	D313		
Malibu		3.8	1978-1981		HB119x.594	D154		
Malibu		3.8	1983-1983		HB119x.594	D154		

CODE Breakdown

HB 245 x .631

Insert Compound Code

Make/Model	Submodel	Engine (Liter)	Years	Note	FRONT		REAR	
					Hawk #	FMSI	Hawk #	FMSI
CHEVROLET CONT.								
Malibu		4.1	1967-1967		HB103x.590	D313		
Malibu		4.1	1973-1977		HB103x.590	D313		
Malibu		4.3	1983-1983		HB119x.594	D154		
Malibu		4.4	1979-1981		HB119x.594	D154		
Malibu		4.6	1966-1967		HB103x.590	D313		
Malibu		5.0	1973-1973		HB103x.590	D313		
Malibu		5.0	1976-1977		HB103x.590	D313		
Malibu		5.0	1978-1981		HB119x.594	D154		
Malibu		5.0	1983-1983		HB119x.594	D154		
Malibu		5.4	1966-1967		HB103x.590	D313		
Malibu		5.7	1973-1977		HB103x.590	D313		
Malibu		5.7	1978-1981		HB119x.594	D154		
Malibu		5.7	1983-1983		HB119x.594	D154		
Malibu		6.5	1966-1967		HB103x.590	D313		
Malibu		6.6	1974-1976		HB103x.590	D313		
Malibu		7.4	1973-1974		HB103x.590	D313		
Monte Carlo	LS	3.1	1995-1998		HB232x.681	D376		
Monte Carlo	LS	3.4	2000-2004		HB360x.670	D699	HB359x.543	D814
Monte Carlo	LS	3.4	2005-2005		HB536x.704	D1076	HB359x.543	D814
Monte Carlo	LT	3.8	2005-2005		HB536x.704	D1076	HB359x.543	D814
Monte Carlo	SS	3.8	2000-2004		HB360x.670	D699	HB359x.543	D814
Monte Carlo	SS	3.8	2005-2005		HB536x.704	D1076	HB359x.543	D814
Monte Carlo	SS	5.0	1984-1988		HB119x.594	D154		
Monte Carlo	Z34	3.4	1995-1997		HB232x.681	D376		
Monte Carlo	Z34	3.8	1998-1998		HB232x.681	D376		
Monte Carlo		3.1	1999-1999		HB232x.681	D376		
Monte Carlo		3.3	1978-1979		HB119x.594	D154		
Monte Carlo		3.8	1978-1984		HB119x.594	D154		
Monte Carlo		3.8	1999-1999		HB232x.681	D376		
Monte Carlo		4.3	1982-1983		HB119x.594	D154		
Monte Carlo		4.3	1985-1988		HB119x.594	D154		
Monte Carlo		4.4	1979-1982		HB119x.594	D154		
Monte Carlo		5.0	1976-1977		HB103x.590	D313		
Monte Carlo		5.0	1978-1988		HB119x.594	D154		
Monte Carlo		5.7	1970-1977		HB103x.590	D313		
Monte Carlo		5.7	1981-1984		HB119x.594	D154		
Monte Carlo		6.6	1970-1976		HB103x.590	D313		
Monte Carlo		7.4	1970-1975		HB103x.590	D313		
Nova	Concours	4.1	1976-1977		HB103x.590	D313		
Nova	Concours	5.0	1976-1977		HB103x.590	D313		
Nova	Concours	5.7	1976-1977		HB103x.590	D313		
Nova	Custom	4.1	1973-1975		HB103x.590	D313		
Nova	Custom	4.1	1978-1979		HB103x.590	D313		
Nova	Custom	4.3	1975-1975		HB103x.590	D313		
Nova	Custom	5.0	1973-1973		HB103x.590	D313		
Nova	Custom	5.0	1978-1979		HB103x.590	D313		
Nova	Custom	5.7	1973-1975		HB103x.590	D313		
Nova	Custom	5.7	1978-1979		HB103x.590	D313		
Nova		1.6	1986-1988		HB191x.590	D242		
Nova		2.5	1970-1970		HB103x.590	D313		
Nova		3.8	1970-1970		HB103x.590	D313		
Nova		4.1	1970-1979		HB103x.590	D313		
Nova		4.3	1975-1975		HB103x.590	D313		

RACE COMPOUND CODES

DTC-70 - U	DTC-05 - H	MT-4 - L	DR-97 - J
DTC-60 - G	HT-14 - V	Blue 9012 - E	HP Plus - N
DTC-30 - W	HT-10 - S	Black - M	

STREET COMPOUND CODES

HPS Performance Street - F	SuperDuty - P
Performance Ceramic - Z	
LTS Light Truck & SUV - Y	

Make/Model	Submodel	Engine (Liter)	Years	Note	FRONT		REAR	
					Hawk #	FMSI	Hawk #	FMSI
CHEVROLET CONT.								
Nova		5.0	1970-1973		HB103x.590	D313		
Nova		5.0	1976-1979		HB103x.590	D313		
Nova		5.7	1970-1979		HB103x.590	D313		
Nova		6.5	1970-1970		HB103x.590	D313		
Nova		6.6	1970-1970		HB103x.590	D313		
P20 Van		4.8	1979-1989		HB131x.595	D614		
P20 Van		5.7	1979-1989		HB131x.595	D614		
P20 Van		6.2	1982-1989		HB131x.595	D614		
P20 Van		7.4	1979-1979		HB131x.595	D614		
Prizm		1.8	1998-2002		HB321x.650	D741		
R1500 Suburban		5.7	1989-1991		HB131x.595	D614		
R1500 Suburban		6.2	1989-1991		HB131x.595	D614		
R20 Pickup		4.3	1987-1987		HB131x.595	D614		
R20 Pickup		4.8	1987-1988		HB131x.595	D614		
R20 Pickup		5.0	1987-1987		HB131x.595	D614		
R20 Pickup		5.7	1987-1988		HB131x.595	D614		
R20 Pickup		6.2	1987-1988		HB131x.595	D614		
R20 Pickup		7.4	1987-1988		HB131x.595	D614		
R20 Suburban		5.7	1987-1988		HB131x.595	D614		
R20 Suburban		6.2	1987-1988		HB131x.595	D614		
R20 Suburban		7.4	1987-1988		HB131x.595	D614		
R2500 Pickup		6.2	1989-1989		HB131x.595	D614		
R2500 Pickup		7.4	1989-1989		HB131x.595	D614		
R2500 Suburban		5.7	1989-1991		HB131x.595	D614		
R2500 Suburban		6.2	1989-1991		HB131x.595	D614		
R2500 Suburban		7.4	1989-1991		HB131x.595	D614		
R30 Pickup		4.8	1987-1988		HB131x.595	D614		
R30 Pickup		5.7	1987-1988		HB131x.595	D614		
R30 Pickup		6.2	1987-1988		HB131x.595	D614		
R30 Pickup		7.4	1987-1988		HB131x.595	D614		
R3500 Pickup		5.7	1989-1989	w/13 x 3.5 in. Drums	HB337x.791	D149		
R3500 Pickup		5.7	1989-1991	w/13 x 2.5 in. Drums	HB131x.595	D614		
R3500 Pickup		6.2	1989-1989	w/13 x 3.5 in. Drums	HB337x.791	D149		
R3500 Pickup		6.2	1989-1991	w/13 x 2.5 in. Drums	HB131x.595	D614		
R3500 Pickup		7.4	1989-1989	w/13 x 3.5 in. Drums	HB337x.791	D149		
R3500 Pickup		7.4	1989-1991	w/13 x 2.5 in. Drums	HB131x.595	D614		
S10 Blazer		2.5	1985-1988		HB119x.594	D154		
S10 Blazer		2.8	1985-1990		HB119x.594	D154		
S10 Blazer		4.3	1988-1994		HB119x.594	D154		
S10 Pickup		1.9	1982-1985		HB119x.594	D154		
S10 Pickup		2.0	1983-1984		HB119x.594	D154		
S10 Pickup		2.2	1983-1985		HB119x.594	D154		
S10 Pickup		2.2	1994-1996		HB119x.594	D154		
S10 Pickup		2.2	1998-2003	2WD	HB119x.594	D154	HB305x.610	D729
S10 Pickup		2.2	1998-2003	4WD	HB304x.598	D726	HB305x.610	D729
S10 Pickup		2.5	1985-1993		HB119x.594	D154		
S10 Pickup		2.8	1982-1993		HB119x.594	D154		
S10 Pickup		4.3	1988-1996		HB119x.594	D154		
S10 Pickup		4.3	1998-2003	2WD	HB119x.594	D154	HB305x.610	D729
S10 Pickup		4.3	1998-2003	4WD	HB304x.598	D726	HB305x.610	D729
S10 Pickup		4.3	2004-2004		HB304x.598	D726	HB305x.610	D729
Silverado 1500	Classic LS	4.3	2007-2007		HB561x.710	D1092		
Silverado 1500	Classic LS	4.8	2007-2007		HB561x.710	D1092		

CODE Breakdown

HB 245 x .631

Insert Compound Code

Make/Model	Submodel	Engine (Liter)	Years	Note	FRONT		REAR	
					Hawk #	FMSI	Hawk #	FMSI
CHEVROLET CONT.								
Silverado 1500	Classic LS	5.3	2007-2007		HB561x.710	D1092		
Silverado 1500	Classic LT	4.8	2007-2007		HB561x.710	D1092		
Silverado 1500	Classic LT	5.3	2007-2007		HB561x.710	D1092		
Silverado 1500	Classic LT	6.0	2007-2007		HB561x.710	D1092		
Silverado 1500	Classic WT	4.3	2007-2007		HB561x.710	D1092		
Silverado 1500	Classic WT	4.8	2007-2007		HB561x.710	D1092		
Silverado 1500	Classic WT	5.3	2007-2007		HB561x.710	D1092		
Silverado 1500	LS	4.3	2006-2006		HB561x.710	D1092	HB324x.673	D792
Silverado 1500	LS	4.8	2006-2006		HB561x.710	D1092	HB324x.673	D792
Silverado 1500	LS	4.8	2008-2008		HB561x.710	D1092	HB568x.666	D1194
Silverado 1500	LS	5.3	2006-2006		HB561x.710	D1092	HB324x.673	D792
Silverado 1500	LT	4.8	2006-2006		HB561x.710	D1092	HB324x.673	D792
Silverado 1500	LT	4.8	2007-2007	w/Heavy Duty Brakes	HB322x.717	D784	HB324x.673	D792
Silverado 1500	LT	4.8	2007-2007	w/Standard Brakes	HB561x.710	D1092	HB324x.673	D792
Silverado 1500	LT	4.8	2008-2008		HB561x.710	D1092	HB568x.666	D1194
Silverado 1500	LT	5.3	2006-2006		HB561x.710	D1092	HB324x.673	D792
Silverado 1500	LT	5.3	2007-2007	w/Heavy Duty Brakes	HB322x.717	D784	HB324x.673	D792
Silverado 1500	LT	5.3	2007-2007	w/Standard Brakes	HB561x.710	D1092	HB324x.673	D792
Silverado 1500	LT	5.3	2008-2008		HB561x.710	D1092	HB568x.666	D1194
Silverado 1500	LT	6.0	2006-2006		HB561x.710	D1092	HB324x.673	D792
Silverado 1500	LT	6.0	2007-2007	w/Heavy Duty Brakes	HB322x.717	D784	HB324x.673	D792
Silverado 1500	LT	6.0	2007-2007	w/Standard Brakes	HB561x.710	D1092	HB324x.673	D792
Silverado 1500	LT	6.0	2008-2008		HB561x.710	D1092	HB568x.666	D1194
Silverado 1500	LTZ	5.3	2007-2007		HB322x.717	D784	HB324x.673	D792
Silverado 1500	LTZ	5.3	2008-2008		HB561x.710	D1092	HB568x.666	D1194
Silverado 1500	LTZ	6.0	2007-2007		HB322x.717	D784	HB324x.673	D792
Silverado 1500	LTZ	6.0	2008-2008		HB561x.710	D1092	HB568x.666	D1194
Silverado 1500	WT	4.3	2006-2006		HB561x.710	D1092	HB324x.673	D792
Silverado 1500	WT	4.3	2007-2007	w/Heavy Duty Brakes	HB322x.717	D784		
Silverado 1500	WT	4.3	2007-2007	w/Standard Brakes	HB561x.710	D1092		
Silverado 1500	WT	4.3	2008-2008		HB561x.710	D1092		
Silverado 1500	WT	4.8	2006-2006		HB561x.710	D1092	HB324x.673	D792
Silverado 1500	WT	4.8	2007-2007	w/Heavy Duty Brakes	HB322x.717	D784		
Silverado 1500	WT	4.8	2007-2007	w/Standard Brakes	HB561x.710	D1092		
Silverado 1500	WT	4.8	2008-2008		HB561x.710	D1092		
Silverado 1500	WT	5.3	2006-2006		HB561x.710	D1092	HB324x.673	D792
Silverado 1500	WT	5.3	2007-2007	w/Heavy Duty Brakes	HB322x.717	D784		
Silverado 1500	WT	5.3	2007-2007	w/Standard Brakes	HB561x.710	D1092		
Silverado 1500	WT	5.3	2008-2008		HB561x.710	D1092		
Silverado 1500		4.3	1999-2002		HB323x.724	D785	HB324x.673	D792
Silverado 1500		4.3	2003-2003	w/o 4WS	HB323x.724	D785	HB324x.673	D792
Silverado 1500		4.3	2003-2003	w/ 4WS	HB323x.724	D785	HB385x.640	D834
Silverado 1500		4.3	2004-2004	w/o 4WS	HB323x.724	D785	HB494x.670	D974
Silverado 1500		4.3	2005-2005	7200 lbs. GVWR, Crew Cab, Rear Disc w/Hyd. Pwr. Brakes	HB561x.710	D1092	HB323x.724	D785
Silverado 1500		4.3	2005-2005	6400 lbs. GVWR, Rear Disc w/Hyd. Pwr. Brakes	HB561x.710	D1092	HB324x.673	D792
Silverado 1500		4.3	2005-2005	7200 lbs. GVWR, Ext. Cab, w/Hyd. Pwr. Brakes	HB561x.710	D1092	HB385x.640	D834
Silverado 1500		4.3	2005-2005	7200 lbs. GVWR, Crew Cab, Rear Disc w/Vacuum Pwr. Brakes	HB323x.724	D785	HB323x.724	D785
Silverado 1500		4.3	2005-2005	6400 lbs. GVWR, Rear Disc w/Vacuum Pwr. Brakes	HB323x.724	D785	HB324x.673	D792
Silverado 1500		4.3	2005-2005	7200 lbs. GVWR, Ext. Cab, w/Vacuum Pwr. Brakes	HB323x.724	D785	HB385x.640	D834
Silverado 1500		4.8	1999-2002		HB323x.724	D785	HB324x.673	D792
Silverado 1500		4.8	2003-2003	w/o 4WS	HB323x.724	D785	HB324x.673	D792
Silverado 1500		4.8	2003-2003	w/ 4WS	HB323x.724	D785	HB385x.640	D834
Silverado 1500		4.8	2004-2004	w/o 4WS	HB323x.724	D785	HB494x.670	D974

RACE COMPOUND CODES

DTC-70 - U | DTC-05 - H | MT-4 - L | DR-97 - J
 DTC-60 - G | HT-14 - V | Blue 9012 - E | HP Plus - N
 DTC-30 - W | HT-10 - S | Black - M

STREET COMPOUND CODES

HPS Performance Street - F | SuperDuty - P
 Performance Ceramic - Z
 LTS Light Truck & SUV - Y

Make/Model	Submodel	Engine (Liter)	Years	Note	FRONT		REAR	
					Hawk #	FMSI	Hawk #	FMSI
CHEVROLET CONT.								
Silverado 1500		4.8	2005-2005	7200 lbs. GVWR, Crew Cab, Rear Disc w/Hyd. Pwr. Brakes	HB561x.710	D1092	HB323x.724	D785
Silverado 1500		4.8	2005-2005	6400 lbs. GVWR, Rear Disc w/Hyd. Pwr. Brakes	HB561x.710	D1092	HB324x.673	D792
Silverado 1500		4.8	2005-2005	7200 lbs. GVWR, Ext. Cab, w/Hyd. Pwr. Brakes	HB561x.710	D1092	HB385x.640	D834
Silverado 1500		4.8	2005-2005	7200 lbs. GVWR, Crew Cab, Rear Disc w/Vacuum Pwr. Brakes	HB323x.724	D785	HB323x.724	D785
Silverado 1500		4.8	2005-2005	6400 lbs. GVWR, Rear Disc w/Vacuum Pwr. Brakes	HB323x.724	D785	HB324x.673	D792
Silverado 1500		4.8	2005-2005	7200 lbs. GVWR, Ext. Cab, w/Vacuum Pwr. Brakes	HB323x.724	D785	HB385x.640	D834
Silverado 1500		5.3	1999-2002		HB323x.724	D785	HB324x.673	D792
Silverado 1500		5.3	2003-2003	w/o 4WS	HB323x.724	D785	HB324x.673	D792
Silverado 1500		5.3	2003-2003	w/ 4WS	HB323x.724	D785	HB385x.640	D834
Silverado 1500		5.3	2004-2004	w/o 4WS	HB323x.724	D785	HB494x.670	D974
Silverado 1500		5.3	2005-2005	7200 lbs. GVWR, Crew Cab, Rear Disc w/Hyd. Pwr. Brakes	HB561x.710	D1092	HB323x.724	D785
Silverado 1500		5.3	2005-2005	6400 lbs. GVWR, Rear Disc w/Hyd. Pwr. Brakes	HB561x.710	D1092	HB324x.673	D792
Silverado 1500		5.3	2005-2005	7200 lbs. GVWR, Ext. Cab, w/Hyd. Pwr. Brakes	HB561x.710	D1092	HB385x.640	D834
Silverado 1500		5.3	2005-2005	7200 lbs. GVWR, Crew Cab, Rear Disc w/Vacuum Pwr. Brakes	HB323x.724	D785	HB323x.724	D785
Silverado 1500		5.3	2005-2005	6400 lbs. GVWR, Rear Disc w/Vacuum Pwr. Brakes	HB323x.724	D785	HB324x.673	D792
Silverado 1500		5.3	2005-2005	7200 lbs. GVWR, Ext. Cab, w/Vacuum Pwr. Brakes	HB323x.724	D785	HB385x.640	D834
Silverado 1500 HD	Classic LT	6.0	2007-2007		HB322x.717	D784		
Silverado 1500 HD	LT	6.0	2006-2006		HB322x.717	D784	HB323x.724	D785
Silverado 1500 HD		6.0	2001-2003		HB322x.717	D784	HB323x.724	D785
Silverado 1500 HD		6.0	2005-2005		HB322x.717	D784	HB323x.724	D785
Silverado 2500		5.3	2000-2000		HB322x.717	D784		
Silverado 2500		6.0	2000-2000		HB322x.717	D784		
Silverado 2500		6.0	2001-2004		HB322x.717	D784	HB323x.724	D785
Silverado 2500 HD	Classic LS	6.0	2007-2007		HB322x.717	D784	HB323x.724	D785
Silverado 2500 HD	Classic LS	6.6	2007-2007		HB322x.717	D784	HB323x.724	D785
Silverado 2500 HD	Classic LS	8.1	2007-2007		HB322x.717	D784	HB323x.724	D785
Silverado 2500 HD	Classic LT	6.0	2007-2007		HB322x.717	D784	HB323x.724	D785
Silverado 2500 HD	Classic LT	6.6	2007-2007		HB322x.717	D784	HB323x.724	D785
Silverado 2500 HD	Classic LT	8.1	2007-2007		HB322x.717	D784	HB323x.724	D785
Silverado 2500 HD	Classic WT	6.0	2007-2007		HB322x.717	D784	HB323x.724	D785
Silverado 2500 HD	Classic WT	6.6	2007-2007		HB322x.717	D784	HB323x.724	D785
Silverado 2500 HD	Classic WT	8.1	2007-2007		HB322x.717	D784	HB323x.724	D785
Silverado 2500 HD	LS	6.0	2006-2006		HB322x.717	D784	HB323x.724	D785
Silverado 2500 HD	LS	6.6	2006-2006		HB322x.717	D784	HB323x.724	D785
Silverado 2500 HD	LS	8.1	2006-2006		HB322x.717	D784	HB323x.724	D785
Silverado 2500 HD	LT	6.0	2006-2008		HB322x.717	D784	HB323x.724	D785
Silverado 2500 HD	LT	6.6	2006-2008		HB322x.717	D784	HB323x.724	D785
Silverado 2500 HD	LT	8.1	2006-2006		HB322x.717	D784	HB323x.724	D785
Silverado 2500 HD	LTZ	6.0	2007-2008		HB322x.717	D784	HB323x.724	D785
Silverado 2500 HD	LTZ	6.6	2007-2008		HB322x.717	D784	HB323x.724	D785
Silverado 2500 HD	WT	6.0	2006-2008		HB322x.717	D784	HB323x.724	D785
Silverado 2500 HD	WT	6.6	2006-2008		HB322x.717	D784	HB323x.724	D785
Silverado 2500 HD	WT	8.1	2006-2006		HB322x.717	D784	HB323x.724	D785
Silverado 2500 HD		6.0	2001-2005		HB322x.717	D784	HB323x.724	D785
Silverado 2500 HD		6.6	2001-2005		HB322x.717	D784	HB323x.724	D785
Silverado 2500 HD		8.1	2001-2005		HB322x.717	D784	HB323x.724	D785
Silverado 3500	Classic LS	6.0	2007-2007		HB322x.717	D784	HB323x.724	D785
Silverado 3500	Classic LS	6.6	2007-2007		HB322x.717	D784	HB323x.724	D785
Silverado 3500	Classic LS	8.1	2007-2007		HB322x.717	D784	HB323x.724	D785
Silverado 3500	Classic LT	6.0	2007-2007		HB322x.717	D784	HB323x.724	D785
Silverado 3500	Classic LT	6.6	2007-2007		HB322x.717	D784	HB323x.724	D785
Silverado 3500	Classic LT	8.1	2007-2007		HB322x.717	D784	HB323x.724	D785
Silverado 3500	Classic WT	6.0	2007-2007		HB322x.717	D784	HB323x.724	D785

CODE Breakdown

HB 245 x .631

Insert Compound Code

Make/Model	Submodel	Engine (Liter)	Years	Note	FRONT		REAR	
					Hawk #	FMSI	Hawk #	FMSI
CHEVROLET CONT.								
Silverado 3500	Classic WT	6.6	2007-2007		HB322x.717	D784	HB323x.724	D785
Silverado 3500	Classic WT	8.1	2007-2007		HB322x.717	D784	HB323x.724	D785
Silverado 3500	LS	6.0	2006-2006		HB322x.717	D784	HB323x.724	D785
Silverado 3500	LS	6.6	2006-2006		HB322x.717	D784	HB323x.724	D785
Silverado 3500	LS	8.1	2006-2006		HB322x.717	D784	HB323x.724	D785
Silverado 3500	LT	6.0	2006-2006		HB322x.717	D784	HB323x.724	D785
Silverado 3500	LT	6.0	2008-2008		HB322x.717	D784	HB323x.724	D785
Silverado 3500	LT	6.6	2006-2006		HB322x.717	D784	HB323x.724	D785
Silverado 3500	LT	6.6	2008-2008		HB322x.717	D784	HB323x.724	D785
Silverado 3500	LT	8.1	2006-2006		HB322x.717	D784	HB323x.724	D785
Silverado 3500	LTZ	6.0	2008-2008		HB322x.717	D784	HB323x.724	D785
Silverado 3500	LTZ	6.6	2008-2008		HB322x.717	D784	HB323x.724	D785
Silverado 3500	WT	6.0	2006-2006		HB322x.717	D784	HB323x.724	D785
Silverado 3500	WT	6.0	2008-2008		HB322x.717	D784	HB323x.724	D785
Silverado 3500	WT	6.6	2006-2006		HB322x.717	D784	HB323x.724	D785
Silverado 3500	WT	6.6	2008-2008		HB322x.717	D784	HB323x.724	D785
Silverado 3500	WT	8.1	2006-2006		HB322x.717	D784	HB323x.724	D785
Silverado 3500		6.0	2001-2003		HB322x.717	D784		
Silverado 3500		6.0	2004-2005		HB322x.717	D784	HB323x.724	D785
Silverado 3500		6.6	2001-2003		HB322x.717	D784		
Silverado 3500		6.6	2004-2005		HB322x.717	D784	HB323x.724	D785
Silverado 3500		8.1	2001-2003		HB322x.717	D784		
Silverado 3500		8.1	2004-2005		HB322x.717	D784	HB323x.724	D785
SSR		5.3	2003-2004		HB382x.657	D882	HB383x.685	D883
SSR		6.0	2005-2005		HB382x.657	D882	HB383x.685	D883
Suburban 1500	LS	5.3	2005-2006	2WD	HB323x.724	D785	HB494x.670	D974
Suburban 1500	LS	5.3	2007-2008		HB561x.710	D1092	HB568x.666	D1194
Suburban 1500	LT	5.3	2005-2006	2WD	HB323x.724	D785	HB494x.670	D974
Suburban 1500	LT	5.3	2007-2008		HB561x.710	D1092	HB568x.666	D1194
Suburban 1500	LT	6.0	2007-2008		HB561x.710	D1092	HB568x.666	D1194
Suburban 1500	LTZ	5.3	2007-2008		HB561x.710	D1092	HB568x.666	D1194
Suburban 1500	LTZ	6.0	2006-2006	2WD	HB323x.724	D785	HB494x.670	D974
Suburban 1500	LTZ	6.0	2007-2008		HB561x.710	D1092	HB568x.666	D1194
Suburban 1500	Z71	5.3	2005-2006	2WD	HB323x.724	D785	HB494x.670	D974
Suburban 1500		5.3	2000-2002		HB323x.724	D785	HB324x.673	D792
Suburban 1500		5.3	2003-2004	2WD	HB323x.724	D785	HB494x.670	D974
Suburban 1500		5.3	2006-2006	2WD	HB323x.724	D785	HB494x.670	D974
Suburban 2500	LS	6.0	2005-2008		HB322x.717	D784	HB323x.724	D785
Suburban 2500	LS	8.1	2005-2006		HB322x.717	D784	HB323x.724	D785
Suburban 2500	LT	6.0	2005-2008		HB322x.717	D784	HB323x.724	D785
Suburban 2500	LT	8.1	2005-2006		HB322x.717	D784	HB323x.724	D785
Suburban 2500	LTZ	6.0	2007-2007		HB322x.717	D784	HB323x.724	D785
Suburban 2500		6.0	2000-2004		HB322x.717	D784	HB323x.724	D785
Suburban 2500		8.1	2001-2004		HB322x.717	D784	HB323x.724	D785
Tahoe	Hybrid	6.0	2008-2008		HB561x.710	D1092	HB568x.666	D1194
Tahoe	LS	4.8	2005-2005		HB323x.724	D785	HB496x.640	D975
Tahoe	LS	4.8	2005-2006		HB323x.724	D785		
Tahoe	LS	4.8	2006-2006		HB323x.724	D785	HB494x.670	D974
Tahoe	LS	4.8	2007-2008		HB561x.710	D1092	HB568x.666	D1194
Tahoe	LS	5.3	2005-2005		HB323x.724	D785	HB496x.640	D975
Tahoe	LS	5.3	2006-2006		HB323x.724	D785	HB494x.670	D974
Tahoe	LS	5.3	2007-2008		HB561x.710	D1092	HB568x.666	D1194
Tahoe	LT	5.3	2005-2006		HB323x.724	D785	HB496x.640	D975

RACE COMPOUND CODES

DTC-70 - U	DTC-05 - H	MT-4 - L	DR-97 - J
DTC-60 - G	HT-14 - V	Blue 9012 - E	HP Plus - N
DTC-30 - W	HT-10 - S	Black - M	

STREET COMPOUND CODES

HPS Performance Street - F	SuperDuty - P
Performance Ceramic - Z	
LTS Light Truck & SUV - Y	

Make/Model	Submodel	Engine (Liter)	Years	Note	FRONT		REAR	
					Hawk #	FMSI	Hawk #	FMSI
CHEVROLET CONT.								
Tahoe	LT	5.3	2007-2008		HB561x.710	D1092	HB568x.666	D1194
Tahoe	LTZ	5.3	2007-2008		HB561x.710	D1092	HB568x.666	D1194
Tahoe	Z71	5.3	2005-2005		HB323x.724	D785	HB496x.640	D975
Tahoe	Z71	5.3	2006-2006		HB323x.724	D785	HB494x.670	D974
Tahoe		4.8	2000-2000	Police	HB296x.670	D370	HB385x.640	D834
Tahoe		4.8	2000-2000	Except Police	HB332x.654	D369	HB385x.640	D834
Tahoe		4.8	2001-2002		HB323x.724	D785	HB385x.640	D834
Tahoe		4.8	2003-2004		HB323x.724	D785	HB496x.640	D975
Tahoe		4.8	2006-2006		HB323x.724	D785	HB494x.670	D974
Tahoe		5.3	2000-2000	Police	HB296x.670	D370	HB385x.640	D834
Tahoe		5.3	2000-2000	Except Police	HB332x.654	D369	HB385x.640	D834
Tahoe		5.3	2001-2002		HB323x.724	D785	HB385x.640	D834
Tahoe		5.3	2003-2004		HB323x.724	D785	HB496x.640	D975
Tahoe		5.3	2006-2006		HB323x.724	D785	HB494x.670	D974
Tahoe		5.7	1995-1995		HB332x.654	D369		
Tahoe		5.7	1996-2000	Police	HB296x.670	D370		
Tahoe		5.7	1996-2000	Except Police	HB332x.654	D369		
Tahoe		5.7	2000-2000	Police	HB296x.670	D370	HB385x.640	D834
Tahoe		5.7	2000-2000	Except Police	HB332x.654	D369	HB385x.640	D834
Tahoe		6.5	1995-1995		HB332x.654	D369		
Tahoe		6.5	1996-1999	Police	HB296x.670	D370		
Tahoe		6.5	1996-1999	Except Police	HB332x.654	D369		
Tracker		1.6	1998-2000		HB384x.587	D556		
Tracker		2.0	1999-2003		HB384x.587	D556		
Tracker		2.5	2001-2004		HB384x.587	D556		
TrailBlazer	EXT	4.2	2002-2004		HB382x.657	D882	HB383x.685	D883
TrailBlazer	EXT	5.3	2003-2004		HB382x.657	D882	HB383x.685	D883
TrailBlazer	EXT LS	4.2	2005-2005		HB382x.657	D882	HB383x.685	D883
TrailBlazer	EXT LS	5.3	2005-2005		HB382x.657	D882	HB383x.685	D883
TrailBlazer	EXT LT	4.2	2005-2005		HB382x.657	D882	HB383x.685	D883
TrailBlazer	EXT LT	5.3	2005-2005		HB382x.657	D882	HB383x.685	D883
TrailBlazer	LS	4.2	2005-2005		HB382x.657	D882	HB383x.685	D883
TrailBlazer	LT	4.2	2005-2005		HB382x.657	D882	HB383x.685	D883
TrailBlazer		4.2	2002-2004		HB382x.657	D882	HB383x.685	D883
Uplander	LS	3.5	2006-2006		HB360x.670	D699		
Uplander	LS	3.9	2007-2008		HB360x.670	D699		
Uplander	LT	3.5	2006-2006		HB360x.670	D699		
Uplander	LT	3.9	2006-2008		HB360x.670	D699		
Uplander		3.5	2005-2006		HB360x.670	D699		
Uplander		3.9	2007-2008		HB360x.670	D699		
V1500 Suburban		5.7	1989-1991		HB131x.595	D614		
V1500 Suburban		6.2	1989-1991		HB131x.595	D614		
V20 Pickup		4.8	1987-1987		HB131x.595	D614		
V20 Pickup		5.7	1987-1987		HB131x.595	D614		
V20 Pickup		6.2	1987-1987		HB131x.595	D614		
V20 Suburban		5.7	1987-1988		HB131x.595	D614		
V20 Suburban		6.2	1987-1988		HB131x.595	D614		
V20 Suburban		7.4	1987-1988		HB131x.595	D614		
V2500 Suburban		5.7	1989-1991		HB131x.595	D614		
V2500 Suburban		6.2	1989-1991		HB131x.595	D614		
V2500 Suburban		7.4	1990-1990		HB131x.595	D614		
V3500 Pickup		5.7	1989-1991		HB337x.791	D149		
V3500 Pickup		6.2	1989-1991		HB337x.791	D149		

CODE Breakdown

HB 245 x .631

Insert Compound Code

Make/Model	Submodel	Engine (Liter)	Years	Note	FRONT		REAR	
					Hawk #	FMSI	Hawk #	FMSI
CHEVROLET CONT.								
V3500 Pickup		7.4	1989-1991		HB337x.791	D149		
Venture	LS	3.4	2005-2005	FWD	HB360x.670	D699	HB359x.543	D814
Venture	LS	3.4	2005-2005	AWD	HB373x.689	D844	HB359x.543	D814
Venture	LT	3.4	2005-2005	FWD	HB360x.670	D699	HB359x.543	D814
Venture	LT	3.4	2005-2005	AWD	HB373x.689	D844	HB359x.543	D814
Venture	Plus	3.4	2005-2005	FWD	HB360x.670	D699	HB359x.543	D814
Venture	Plus	3.4	2005-2005	AWD	HB373x.689	D844	HB359x.543	D814
Venture		3.4	1997-2000		HB360x.670	D699		
Venture		3.4	2001-2001		HB360x.670	D699	HB359x.543	D814
Venture		3.4	2002-2004	FWD	HB360x.670	D699	HB359x.543	D814
Venture		3.4	2002-2004	AWD	HB373x.689	D844	HB359x.543	D814
CHRYSLER								
300	C	5.7	2005-2007	w/Standard Brakes	HB507x.711	D1056	HB508x.675	D1057
300	C	5.7	2005-2007	w/Heavy Duty Brakes	HB509x.678	D1058	HB508x.675	D1057
300	C	5.7	2008-2008	RWD	HB507x.711	D1056	HB508x.675	D1057
300	C	5.7	2008-2008	AWD	HB509x.678	D1058	HB508x.675	D1057
300	C	6.1	2008-2008	RWD	HB507x.711	D1056	HB508x.675	D1057
300	C	6.1	2008-2008	AWD	HB509x.678	D1058	HB508x.675	D1057
300	C LWB	5.7	2007-2007	w/Standard Brakes	HB507x.711	D1056	HB508x.675	D1057
300	C LWB	5.7	2007-2007	w/Heavy Duty Brakes	HB509x.678	D1058	HB508x.675	D1057
300	C SRT-8	6.1	2005-2007		HB563x.656	D1149	HB194x.570	D592
300	Limited	3.5	2005-2007	w/Standard Brakes	HB507x.711	D1056	HB508x.675	D1057
300	Limited	3.5	2005-2007	w/Heavy Duty Brakes	HB509x.678	D1058	HB508x.675	D1057
300	Limited	3.5	2008-2008	RWD	HB507x.711	D1056	HB508x.675	D1057
300	Limited	3.5	2008-2008	AWD	HB509x.678	D1058	HB508x.675	D1057
300	Touring	3.5	2005-2007	w/Standard Brakes	HB507x.711	D1056	HB508x.675	D1057
300	Touring	3.5	2005-2007	w/Heavy Duty Brakes	HB509x.678	D1058	HB508x.675	D1057
300	Touring	3.5	2008-2008	RWD	HB507x.711	D1056	HB508x.675	D1057
300	Touring	3.5	2008-2008	AWD	HB509x.678	D1058	HB508x.675	D1057
300	Touring LWB	3.5	2007-2007	w/Standard Brakes	HB507x.711	D1056	HB508x.675	D1057
300	Touring LWB	3.5	2007-2007	w/Heavy Duty Brakes	HB509x.678	D1058	HB508x.675	D1057
300		2.7	2005-2007	w/Standard Brakes	HB507x.711	D1056	HB508x.675	D1057
300		2.7	2005-2007	w/Heavy Duty Brakes	HB509x.678	D1058	HB508x.675	D1057
300M	Pro-Am Edition	3.5	2003-2003		HB260x.670	D730	HB176x.614	D641
300M	Special	3.5	2002-2004		HB260x.670	D730	HB176x.614	D641
300M		3.5	1999-2000		HB260x.670	D730		
300M		3.5	2001-2004		HB260x.670	D730	HB176x.614	D641
Aspen	Limited	4.7	2007-2008		HB559x.695	D1084	HB513x.610	D967
Aspen	Limited	5.7	2007-2008		HB559x.695	D1084	HB513x.610	D967
Cirrus	LX	2.4	1995-1997		HB233x.635	D650		
Cirrus	LX	2.5	1995-1997		HB233x.635	D650		
Cirrus	LXi	2.4	1997-1997		HB233x.635	D650	HB176x.614	D641
Cirrus	LXi	2.5	1995-1997		HB233x.635	D650	HB176x.614	D641
Cirrus		2.0	2000-2000		HB233x.635	D650		
Cirrus		2.4	2000-2000		HB233x.635	D650		
Cirrus		2.5	1998-1998		HB233x.635	D650	HB176x.614	D641
Cirrus		2.5	1999-2000		HB233x.635	D650		
Concorde	Limited	3.5	2002-2004		HB260x.670	D730	HB176x.614	D641
Concorde	LX	2.7	2002-2004		HB260x.670	D730	HB176x.614	D641
Concorde	LX	3.3	1996-1996		HB177x.710	D642	HB176x.614	D641
Concorde	LX	3.5	1996-1997		HB177x.710	D642	HB176x.614	D641
Concorde	LXi	3.5	1996-1997		HB177x.710	D642	HB176x.614	D641

RACE COMPOUND CODES

DTC-70 - U | DTC-05 - H | MT-4 - L | DR-97 - J
 DTC-60 - G | HT-14 - V | Blue 9012 - E | HP Plus - N
 DTC-30 - W | HT-10 - S | Black - M

STREET COMPOUND CODES

HPS Performance Street - F | SuperDuty - P
 Performance Ceramic - Z
 LTS Light Truck & SUV - Y

Make/Model	Submodel	Engine		Note	FRONT		REAR	
		(Liter)	Years		Hawk #	FMSI	Hawk #	FMSI
CHRYSLER CONT.								
Concorde	LXi	3.5	2002-2004		HB260x.670	D730	HB176x.614	D641
Concorde		2.7	1998-2001		HB260x.670	D730	HB176x.614	D641
Concorde		3.2	1998-2001		HB260x.670	D730	HB176x.614	D641
Concorde		3.3	1993-1994		HB241x.710	D591	HB176x.614	D641
Concorde		3.3	1995-1995		HB177x.710	D642	HB176x.614	D641
Concorde		3.5	1993-1994		HB241x.710	D591	HB176x.614	D641
Concorde		3.5	1993-1995				HB176x.614	D641
Concorde		3.5	1995-1995		HB177x.710	D642	HB176x.614	D641
Crossfire	Limited	3.2	2006-2006		HB497x.776	D682		
Crossfire	SRT-6	3.2	2005-2006		HB497x.776	D682		
Crossfire		3.2	2006-2006		HB497x.776	D682		
Imperial		3.3	1991-1991		HB411x.717	D521	HB176x.614	D641
Imperial		3.8	1991-1993		HB411x.717	D521	HB176x.614	D641
Lebaron	GTC	2.5	1991-1992	Disc	HB410x.721	D522	HB176x.614	D641
Lebaron	GTC	2.5	1991-1992	Drum	HB411x.717	D521		
Lebaron	GTC	3.0	1991-1994	Disc	HB410x.721	D522	HB176x.614	D641
Lebaron	GTC	3.0	1991-1994	Drum	HB411x.717	D521		
Lebaron	Landau	2.5	1992-1992	Disc	HB410x.721	D522	HB176x.614	D641
Lebaron	Landau	2.5	1992-1992	Drum	HB411x.717	D521		
Lebaron	Landau	3.0	1992-1994	Disc	HB410x.721	D522	HB176x.614	D641
Lebaron	Landau	3.0	1992-1994	Drum	HB411x.717	D521		
Lebaron	LE	2.5	1993-1993	Disc	HB410x.721	D522	HB176x.614	D641
Lebaron	LE	2.5	1993-1993	Drum	HB411x.717	D521		
Lebaron	LE	3.0	1993-1994	Disc	HB410x.721	D522	HB176x.614	D641
Lebaron	LE	3.0	1993-1994	Drum	HB411x.717	D521		
Lebaron	LX	3.0	1991-1993	Disc	HB410x.721	D522	HB176x.614	D641
Lebaron	LX	3.0	1991-1993	Drum	HB411x.717	D521		
Lebaron		2.5	1991-1993	Disc	HB410x.721	D522	HB176x.614	D641
Lebaron		2.5	1991-1993	Drum	HB411x.717	D521		
Lebaron		3.0	1991-1993	Disc	HB410x.721	D522	HB176x.614	D641
Lebaron		3.0	1991-1993	Drum	HB411x.717	D521		
LHS		3.5	1994-1994		HB241x.710	D591	HB176x.614	D641
LHS		3.5	1995-1997		HB177x.710	D642	HB176x.614	D641
LHS		3.5	1999-2001		HB260x.670	D730	HB176x.614	D641
New Yorker	Fifth Avenue	3.3	1991-1993		HB411x.717	D521	HB176x.614	D641
New Yorker	Fifth Avenue	3.8	1991-1993		HB411x.717	D521	HB176x.614	D641
New Yorker	Salon	3.3	1991-1993		HB411x.717	D521	HB176x.614	D641
New Yorker		3.5	1994-1994		HB241x.710	D591	HB176x.614	D641
New Yorker		3.5	1995-1996		HB177x.710	D642	HB176x.614	D641
Pacifica	Limited	3.5	2006-2006		HB433x.654	D997		
Pacifica	Limited	4.0	2007-2008		HB433x.654	D997		
Pacifica	LX	3.8	2008-2008		HB433x.654	D997		
Pacifica	LX	4.0	2008-2008		HB433x.654	D997		
Pacifica	Touring	3.5	2006-2006		HB433x.654	D997		
Pacifica	Touring	4.0	2007-2008		HB433x.654	D997		
Pacifica		3.5	2004-2006		HB433x.654	D997		
Pacifica		3.8	2005-2007		HB433x.654	D997		
Pacifica		4.0	2007-2007		HB433x.654	D997		
Prowler		3.5	2001-2002		HB260x.670	D730	HB260x.670	D730
PT Cruiser	GT	2.4	2006-2006		HB371x.600	D841	HB176x.614	D641
PT Cruiser	GT	2.4	2007-2007		HB371x.600	D841		
PT Cruiser	Limited	2.4	2006-2006		HB371x.600	D841	HB176x.614	D641
PT Cruiser	Limited	2.4	2007-2007		HB371x.600	D841		

CODE Breakdown

HB 245 x .631

Insert Compound Code

Make/Model	Submodel	Engine (Liter)	Years	Note	FRONT		REAR	
					Hawk #	FMSI	Hawk #	FMSI
CHRYSLER CONT.								
PT Cruiser	Limited	2.4	2008-2008		HB371x.600	D841	HB176x.614	D641
PT Cruiser	LX	2.4	2008-2008		HB371x.600	D841	HB176x.614	D641
PT Cruiser	Street Cruiser	2.4	2006-2006		HB371x.600	D841	HB176x.614	D641
PT Cruiser	Touring	2.4	2006-2006		HB371x.600	D841	HB176x.614	D641
PT Cruiser	Touring	2.4	2007-2007		HB371x.600	D841		
PT Cruiser	Touring	2.4	2008-2008		HB371x.600	D841	HB176x.614	D641
PT Cruiser	Turbo	2.4	2003-2004		HB371x.600	D841	HB176x.614	D641
PT Cruiser		2.4	2001-2006		HB371x.600	D841	HB176x.614	D641
PT Cruiser		2.4	2007-2007		HB371x.600	D841		
PT Cruiser		2.4	2008-2008		HB371x.600	D841	HB176x.614	D641
Sebring	GTC	2.7	2006-2006		HB498x.772	D869	HB176x.614	D641
Sebring	JX	2.4	1996-1998		HB233x.635	D650	HB176x.614	D641
Sebring	JX	2.5	1996-2000		HB233x.635	D650	HB176x.614	D641
Sebring	JXi	2.4	1997-1998		HB233x.635	D650	HB176x.614	D641
Sebring	JXi	2.5	1996-2000		HB233x.635	D650	HB176x.614	D641
Sebring	Limited	2.4	2008-2008		HB435x.622	D866		
Sebring	Limited	2.7	2006-2006		HB498x.772	D869	HB176x.614	D641
Sebring	Limited	3.5	2008-2008		HB435x.622	D866		
Sebring	LX	2.0	1995-1999		HB213x.626	D484	HB367x.585	D383
Sebring	LX	2.5	1995-2000		HB213x.626	D484	HB367x.585	D383
Sebring	LXi	2.5	1995-2000		HB213x.626	D484	HB367x.585	D383
Sebring	Touring	2.4	2008-2008		HB435x.622	D866		
Sebring	Touring	2.7	2006-2006		HB498x.772	D869	HB176x.614	D641
Sebring	Touring	2.7	2008-2008		HB435x.622	D866		
Sebring	TSi	2.7	2006-2006		HB498x.772	D869	HB176x.614	D641
Town & Country	Limited	3.8	2006-2007	Disc	HB374x.700	D857	HB372x.626	D858
Town & Country	LX	3.3	1996-1998		HB177x.710	D642		
Town & Country	LX	3.3	2001-2001	Disc	HB374x.700	D857	HB372x.626	D858
Town & Country	LX	3.3	2006-2007	Disc	HB374x.700	D857	HB372x.626	D858
Town & Country	LX	3.8	1996-1998		HB177x.710	D642		
Town & Country	LXi	3.3	2001-2001	Disc	HB374x.700	D857	HB372x.626	D858
Town & Country	LXi	3.8	1996-1998		HB177x.710	D642		
Town & Country	Touring	3.8	2006-2007	Disc	HB374x.700	D857	HB372x.626	D858
Town & Country		3.3	1991-1993	15 in. Wheel	HB410x.721	D522		
Town & Country		3.3	1991-1993	14 in. Wheel	HB411x.717	D521		
Town & Country		3.3	1996-1996		HB177x.710	D642		
Town & Country		3.3	1999-2000		HB177x.710	D642		
Town & Country		3.3	2002-2007	Disc	HB374x.700	D857	HB372x.626	D858
Town & Country		3.3	2004-2004	Drum	HB373x.689	D844		
Town & Country		3.8	1994-1994	15 in. Wheel	HB410x.721	D522		
Town & Country		3.8	1994-1995	14 in. Wheel	HB411x.717	D521		
Town & Country		3.8	1996-1996		HB177x.710	D642		
Town & Country		3.8	1999-2000		HB177x.710	D642		
Town & Country		3.8	2001-2005	Disc	HB374x.700	D857	HB372x.626	D858
DODGE								
Avenger	ES	2.0	1996-1998		HB213x.626	D484	HB367x.585	D383
Avenger	ES	2.5	1995-1998		HB213x.626	D484	HB367x.585	D383
Avenger	R/T	3.5	2008-2008	FWD	HB435x.622	D866		
Avenger		2.0	1995-1996		HB213x.626	D484		
Avenger		2.0	1997-1999		HB213x.626	D484	HB367x.585	D383
Avenger		2.5	1997-2000		HB213x.626	D484	HB367x.585	D383
B150 Van	Sportsman	3.7	1984-1987		HB398x.680	D269		

RACE COMPOUND CODES

DTC-70 - U | DTC-05 - H | MT-4 - L | DR-97 - J
 DTC-60 - G | HT-14 - V | Blue 9012 - E | HP Plus - N
 DTC-30 - W | HT-10 - S | Black - M

STREET COMPOUND CODES

HPS Performance Street - F | SuperDuty - P
 Performance Ceramic - Z
 LTS Light Truck & SUV - Y

Make/Model	Submodel	Engine (Liter)	Years	Note	FRONT		REAR	
					Hawk #	FMSI	Hawk #	FMSI
DODGE CONT.								
B150 Van	Sportsman	3.9	1988-1994		HB398x.680	D269		
B150 Van	Sportsman	5.2	1984-1994		HB398x.680	D269		
B150 Van		3.7	1984-1987		HB398x.680	D269		
B150 Van		3.9	1988-1994		HB398x.680	D269		
B150 Van		5.2	1984-1994		HB398x.680	D269		
B1500 Van	Sportsman	3.9	1995-1997		HB398x.680	D269		
B1500 Van	Sportsman	5.2	1995-1997		HB398x.680	D269		
B1500 Van		3.9	1995-1997		HB398x.680	D269		
B1500 Van		3.9	1998-1998		HB300x.622	D758		
B1500 Van		5.2	1995-1997		HB398x.680	D269		
B1500 Van		5.2	1998-1998		HB300x.622	D758		
B1500 Van		5.9	1998-1998		HB300x.622	D758		
B250 Van	Sportsman	3.7	1984-1987		HB398x.680	D269		
B250 Van	Sportsman	3.9	1988-1994		HB398x.680	D269		
B250 Van	Sportsman	5.2	1984-1994		HB398x.680	D269		
B250 Van	Sportsman	5.9	1984-1994		HB398x.680	D269		
B250 Van		3.7	1984-1987		HB398x.680	D269		
B250 Van		3.9	1988-1994		HB398x.680	D269		
B250 Van		5.2	1984-1994		HB398x.680	D269		
B250 Van		5.9	1984-1994		HB398x.680	D269		
B2500 Van	Sportsman	3.9	1995-1996		HB398x.680	D269		
B2500 Van	Sportsman	5.2	1995-1997		HB398x.680	D269		
B2500 Van	Sportsman	5.9	1995-1997		HB398x.680	D269		
B2500 Van		3.9	1995-1997		HB398x.680	D269		
B2500 Van		5.2	1995-1998		HB398x.680	D269		
B2500 Van		5.2	1998-1998		HB334x.705	D655		
B2500 Van		5.9	1995-1998		HB398x.680	D269		
B2500 Van		5.9	1998-1998		HB334x.705	D655		
B350 Van	Sportsman	5.2	1984-1994		HB398x.680	D269		
B350 Van	Sportsman	5.9	1984-1994		HB398x.680	D269		
B350 Van		5.2	1984-1994		HB398x.680	D269		
B350 Van		5.9	1984-1994		HB398x.680	D269		
B3500 Van	Sportsman	5.2	1995-1997		HB398x.680	D269		
B3500 Van	Sportsman	5.9	1995-1997		HB398x.680	D269		
B3500 Van		5.2	1995-1998		HB398x.680	D269		
B3500 Van		5.2	1998-1998		HB334x.705	D655		
B3500 Van		5.9	1995-1998		HB398x.680	D269		
B3500 Van		5.9	1998-1998		HB334x.705	D655		
Caliber	R/T	2.4	2007-2008		HB435x.622	D866	HB457x.605	D1037
Caliber	SE	1.8	2008-2008		HB435x.622	D866		
Caliber	SE	2.0	2008-2008		HB435x.622	D866		
Caliber	SRT-4	2.4	2008-2008		HB509x.678	D1058		
Caliber	SXT	1.8	2008-2008		HB435x.622	D866	HB457x.605	D1037
Caliber	SXT	2.0	2008-2008		HB435x.622	D866	HB457x.605	D1037
Caravan	Cargo Van	2.5	1991-1991	AWD	HB410x.721	D522		
Caravan	Cargo Van	2.5	1991-1994	FWD	HB411x.717	D521		
Caravan	Cargo Van	2.5	1994-1994	AWD	HB410x.721	D522		
Caravan	Cargo Van	2.5	1995-1995		HB411x.717	D521		
Caravan	Cargo Van	3.0	1991-1992	AWD	HB410x.721	D522		
Caravan	Cargo Van	3.0	1991-1994	FWD	HB411x.717	D521		
Caravan	Cargo Van	3.0	1994-1994	AWD	HB410x.721	D522		
Caravan	Cargo Van	3.0	1995-1995		HB411x.717	D521		
Caravan	Cargo Van	3.3	1991-1992	AWD	HB410x.721	D522		

CODE Breakdown

HB 245 x .631

Insert Compound Code

Make/Model	Submodel	Engine (Liter)	Years	Note	FRONT		REAR	
					Hawk #	FMSI	Hawk #	FMSI
DODGE CONT.								
Caravan	Cargo Van	3.3	1991-1994	FWD	HB411x.717	D521		
Caravan	Cargo Van	3.3	1994-1994	AWD	HB410x.721	D522		
Caravan	Cargo Van	3.3	1995-1995		HB411x.717	D521		
Caravan	ES	3.0	1993-1994	AWD	HB410x.721	D522		
Caravan	ES	3.0	1993-1994	FWD	HB411x.717	D521		
Caravan	ES	3.0	1995-1995		HB411x.717	D521		
Caravan	ES	3.3	1993-1994	AWD	HB410x.721	D522		
Caravan	ES	3.3	1993-1994	FWD	HB411x.717	D521		
Caravan	ES	3.3	1995-1995		HB411x.717	D521		
Caravan	ES	3.3	1996-1997		HB177x.710	D642		
Caravan	ES	3.8	1996-1997		HB177x.710	D642		
Caravan	LE	2.5	1991-1991	AWD	HB410x.721	D522		
Caravan	LE	2.5	1991-1991	FWD	HB411x.717	D521		
Caravan	LE	3.0	1991-1994	AWD	HB410x.721	D522		
Caravan	LE	3.0	1991-1994	FWD	HB411x.717	D521		
Caravan	LE	3.0	1995-1995		HB411x.717	D521		
Caravan	LE	3.3	1991-1994	AWD	HB410x.721	D522		
Caravan	LE	3.3	1991-1994	FWD	HB411x.717	D521		
Caravan	LE	3.3	1995-1995		HB411x.717	D521		
Caravan	LE	3.3	1996-1997		HB177x.710	D642		
Caravan	LE	3.8	1996-1997		HB177x.710	D642		
Caravan	SE	2.4	1996-1997		HB177x.710	D642		
Caravan	SE	2.4	2004-2004	Drum	HB373x.689	D844		
Caravan	SE	2.4	2005-2005		HB374x.700	D857	HB372x.626	D858
Caravan	SE	2.4	2006-2007	Drum	HB373x.689	D844		
Caravan	SE	2.4	2006-2007	Disc	HB374x.700	D857	HB372x.626	D858
Caravan	SE	2.5	1991-1993	AWD	HB410x.721	D522		
Caravan	SE	2.5	1991-1993	FWD	HB411x.717	D521		
Caravan	SE	3.0	1991-1994	AWD	HB410x.721	D522		
Caravan	SE	3.0	1991-1994	FWD	HB411x.717	D521		
Caravan	SE	3.0	1995-1995		HB411x.717	D521		
Caravan	SE	3.0	1996-1997		HB177x.710	D642		
Caravan	SE	3.3	1991-1994	AWD	HB410x.721	D522		
Caravan	SE	3.3	1991-1994	FWD	HB411x.717	D521		
Caravan	SE	3.3	1995-1995		HB411x.717	D521		
Caravan	SE	3.3	1996-1997		HB177x.710	D642		
Caravan	SE	3.3	2001-2001	Disc	HB374x.700	D857	HB372x.626	D858
Caravan	SE	3.3	2001-2004	Drum	HB373x.689	D844		
Caravan	SE	3.3	2006-2007	Drum	HB373x.689	D844		
Caravan	SE	3.3	2006-2007	Disc	HB374x.700	D857	HB372x.626	D858
Caravan	SE		1999-1999		HB177x.710	D642		
Caravan	Sport	3.3	2001-2001	Drum	HB373x.689	D844		
Caravan	SXT	3.3	2006-2006		HB374x.700	D857	HB372x.626	D858
Caravan	SXT	3.3	2006-2007	Drum	HB373x.689	D844		
Caravan	SXT	3.3	2007-2007	Disc	HB374x.700	D857		
Caravan		2.4	1996-2000		HB177x.710	D642		
Caravan		2.4	2001-2001	Disc	HB374x.700	D857	HB372x.626	D858
Caravan		2.4	2001-2003	Drum	HB373x.689	D844		
Caravan		2.5	1995-1995		HB411x.717	D521		
Caravan		3.0	1995-1995		HB411x.717	D521		
Caravan		3.0	1996-2000		HB177x.710	D642		
Caravan		3.3	1995-1995		HB411x.717	D521		

RACE COMPOUND CODES

DTC-70 - U	DTC-05 - H	MT-4 - L	DR-97 - J
DTC-60 - G	HT-14 - V	Blue 9012 - E	HP Plus - N
DTC-30 - W	HT-10 - S	Black - M	

STREET COMPOUND CODES

HPS Performance Street - F	SuperDuty - P
Performance Ceramic - Z	
LTS Light Truck & SUV - Y	

Make/Model	Submodel	Engine		Note	FRONT		REAR	
		(Liter)	Years		Hawk #	FMSI	Hawk #	FMSI
DODGE CONT.								
Caravan		3.3	1997-2000		HB177x.710	D642		
Caravan		3.3	2001-2001	Disc	HB374x.700	D857	HB372x.626	D858
Caravan		3.3	2001-2004	Drum	HB373x.689	D844		
Caravan		3.3	2003-2004	Disc	HB374x.700	D857	HB372x.626	D858
Caravan		3.3	2005-2007		HB374x.700	D857	HB372x.626	D858
Caravan		3.8	1998-1999		HB177x.710	D642		
Caravan			1995-1995		HB411x.717	D521		
Caravan			1997-1998		HB177x.710	D642		
Challenger	SRT-8	6.1	2008-2008		HB509x.678	D1058		
Charger	Daytona R/T	5.7	2006-2006	w/Heavy Duty Brakes	HB509x.678	D1058	HB508x.586	D1057
Charger	Daytona R/T	5.7	2006-2006	w/Standard Brakes	HB507x.711	D1056	HB508x.675	D1057
Charger	R/T	5.7	2006-2006	w/Heavy Duty Brakes	HB509x.678	D1058	HB508x.586	D1057
Charger	R/T	5.7	2006-2006	w/Standard Brakes	HB507x.711	D1056	HB508x.675	D1057
Charger	R/T	5.7	2007-2007	RWD, w/Standard Brakes	HB507x.711	D1056	HB508x.675	D1057
Charger	R/T	5.7	2007-2008	AWD, w/Heavy Duty Brakes	HB509x.678	D1058	HB508x.586	D1057
Charger	R/T	5.7	2008-2008	RWD, w/Heavy Duty Brakes	HB507x.711	D1056		
Charger	SE	2.7	2007-2007	w/Standard Brakes	HB507x.711	D1056	HB508x.675	D1057
Charger	SE	2.7	2007-2008	AWD, w/Heavy Duty Brakes	HB509x.678	D1058	HB508x.586	D1057
Charger	SE	2.7	2008-2008	RWD, w/Heavy Duty Brakes	HB507x.711	D1056		
Charger	SE	3.5	2006-2006	w/Heavy Duty Brakes	HB509x.678	D1058	HB508x.586	D1057
Charger	SE	3.5	2006-2006	w/Standard Brakes	HB507x.711	D1056	HB508x.675	D1057
Charger	SE	3.5	2007-2007	RWD, w/Standard Brakes	HB507x.711	D1056	HB508x.675	D1057
Charger	SE	3.5	2007-2008	AWD, w/Heavy Duty Brakes	HB509x.678	D1058	HB508x.586	D1057
Charger	SE	3.5	2008-2008	RWD, w/Heavy Duty Brakes	HB507x.711	D1056		
Charger	SRT-8	6.1	2006-2007		HB563x.656	D1149	HB194x.570	D592
Charger	SXT	3.5	2006-2006	w/Heavy Duty Brakes	HB509x.678	D1058	HB508x.586	D1057
Charger	SXT	3.5	2006-2006	w/Standard Brakes	HB507x.711	D1056	HB508x.675	D1057
Charger	SXT	3.5	2007-2007	RWD, w/Standard Brakes	HB507x.711	D1056	HB508x.675	D1057
Charger	SXT	3.5	2007-2008	AWD, w/Heavy Duty Brakes	HB509x.678	D1058	HB508x.586	D1057
Charger	SXT	3.5	2008-2008	RWD, w/Heavy Duty Brakes	HB507x.711	D1056		
Charger		2.7	2006-2007	w/Heavy Duty Brakes	HB509x.678	D1058	HB508x.586	D1057
Charger		2.7	2006-2007	w/Standard Brakes	HB507x.711	D1056	HB508x.675	D1057
Colt	ES	1.5	1994-1994		HB230x.575	D602		
Colt	ES	1.8	1994-1994		HB230x.575	D602		
Colt	GL	1.5	1991-1993		HB230x.575	D602		
Colt	GL	1.8	1993-1993		HB230x.575	D602		
Colt		1.5	1991-1994		HB230x.575	D602		
Colt		1.8	1994-1994		HB230x.575	D602		
D100 Pickup		3.7	1986-1987		HB398x.680	D269		
D100 Pickup		3.9	1988-1989		HB398x.680	D269		
D100 Pickup		5.2	1986-1989		HB398x.680	D269		
D100 Pickup		5.9	1986-1988		HB398x.680	D269		
D150 Pickup	S	3.9	1990-1991		HB398x.680	D269		
D150 Pickup	S	5.2	1990-1991		HB398x.680	D269		
D150 Pickup		3.7	1984-1987		HB398x.680	D269		
D150 Pickup		3.9	1988-1993		HB398x.680	D269		
D150 Pickup		5.2	1984-1993		HB398x.680	D269		
D150 Pickup		5.9	1984-1991		HB398x.680	D269		
D150 Pickup		5.9	1993-1993		HB398x.680	D269		
D250 Pickup		3.7	1984-1987		HB398x.680	D269		
D250 Pickup		3.9	1988-1993		HB398x.680	D269		
D250 Pickup		5.2	1984-1993		HB398x.680	D269		

CODE Breakdown

HB 245 x .631

Insert Compound Code

Make/Model	Submodel	Engine (Liter)	Years	Note	FRONT		REAR	
					Hawk #	FMSI	Hawk #	FMSI
DODGE CONT.								
D250 Pickup		5.9	1984-1993		HB398x.680	D269		
D350 Pickup		5.9	1984-1993		HB398x.680	D269		
Dakota	Laramie	3.7	2006-2006	Crew Cab, Extended Cab	HB559x.695	D1084		
Dakota	Laramie	3.7	2007-2007		HB559x.695	D1084		
Dakota	Laramie	4.7	2006-2006	Crew Cab, Extended Cab	HB559x.695	D1084		
Dakota	Laramie	4.7	2007-2008		HB559x.695	D1084		
Dakota	SLT	3.7	2006-2008		HB559x.695	D1084		
Dakota	SLT	4.7	2006-2008		HB559x.695	D1084		
Dakota	Sport	3.7	2008-2008		HB559x.695	D1084		
Dakota	Sport	3.9	1991-1991		HB308x.689	D529		
Dakota	Sport	4.7	2008-2008		HB559x.695	D1084		
Dakota	Sport	5.2	1991-1991		HB308x.689	D529		
Dakota	ST	3.7	2006-2008		HB559x.695	D1084		
Dakota	ST	4.7	2006-2007		HB559x.695	D1084		
Dakota	SXT	3.7	2008-2008		HB559x.695	D1084		
Dakota	SXT	4.7	2008-2008		HB559x.695	D1084		
Dakota	TRX	3.7	2008-2008		HB559x.695	D1084		
Dakota	TRX	4.7	2008-2008		HB559x.695	D1084		
Dakota	TRX4	3.7	2008-2008		HB559x.695	D1084		
Dakota	TRX4	4.7	2008-2008		HB559x.695	D1084		
Dakota		2.5	1991-1998		HB308x.689	D529		
Dakota		2.5	1999-1999		HB306x.795	D746		
Dakota		2.5	2000-2002		HB307x.795	D820		
Dakota		3.7	2004-2004		HB476x.707	D962	HB503x.790	D963
Dakota		3.7	2005-2005		HB559x.695	D1084		
Dakota		3.9	1991-1998		HB308x.689	D529		
Dakota		3.9	1999-1999		HB306x.795	D746		
Dakota		3.9	2000-2002		HB307x.795	D820		
Dakota		3.9	2003-2003		HB476x.707	D962	HB503x.790	D963
Dakota		4.7	2000-2002		HB307x.795	D820		
Dakota		4.7	2003-2004		HB476x.707	D962	HB503x.790	D963
Dakota		4.7	2005-2005		HB559x.695	D1084		
Dakota		5.2	1991-1998		HB308x.689	D529		
Dakota		5.2	1999-1999		HB306x.795	D746		
Dakota		5.9	2000-2002		HB307x.795	D820		
Dakota		5.9	2003-2003		HB476x.707	D962	HB503x.790	D963
Dart	270	2.8	1968-1968		HB471x.510	D11		
Dart	270	3.7	1968-1968		HB471x.510	D11		
Dart	270	4.5	1968-1968		HB471x.510	D11		
Dart	270	5.2	1968-1968		HB471x.510	D11		
Dart	270	5.6	1968-1968		HB471x.510	D11		
Dart	270	6.3	1968-1968		HB471x.510	D11		
Dart	Custom	2.8	1969-1969		HB471x.510	D11		
Dart	Custom	3.2	1970-1972		HB471x.510	D11		
Dart	Custom	3.7	1969-1972		HB471x.510	D11		
Dart	Custom	4.5	1969-1969		HB471x.510	D11		
Dart	Custom	5.2	1969-1972		HB471x.510	D11		
Dart	Demon	3.2	1971-1972		HB471x.510	D11		
Dart	Demon	3.7	1971-1972		HB471x.510	D11		
Dart	Demon	5.2	1971-1972		HB471x.510	D11		
Dart	Demon 340	5.6	1971-1972		HB471x.510	D11		
Dart	GT	2.8	1968-1969		HB471x.510	D11		

RACE COMPOUND CODES

DTC-70 - U	DTC-05 - H	MT-4 - L	DR-97 - J
DTC-60 - G	HT-14 - V	Blue 9012 - E	HP Plus - N
DTC-30 - W	HT-10 - S	Black - M	

STREET COMPOUND CODES

HPS Performance Street - F	SuperDuty - P
Performance Ceramic - Z	
LTS Light Truck & SUV - Y	

Make/Model	Submodel	Engine		Note	FRONT		REAR	
		(Liter)	Years		Hawk #	FMSI	Hawk #	FMSI
DODGE CONT.								
Dart	GT	3.7	1968-1969		HB471x.510	D11		
Dart	GT	4.5	1968-1969		HB471x.510	D11		
Dart	GT	5.2	1968-1969		HB471x.510	D11		
Dart	GT	5.6	1968-1969		HB471x.510	D11		
Dart	GT	6.3	1968-1968		HB471x.510	D11		
Dart	GTS	4.5	1968-1969		HB471x.510	D11		
Dart	GTS	5.2	1968-1969		HB471x.510	D11		
Dart	GTS	5.6	1968-1969		HB471x.510	D11		
Dart	GTS	6.3	1968-1969		HB471x.510	D11		
Dart	Special	3.2	1971-1972		HB471x.510	D11		
Dart	Special	3.7	1971-1972		HB471x.510	D11		
Dart	Special	5.2	1971-1972		HB471x.510	D11		
Dart	Swinger	2.8	1969-1969		HB471x.510	D11		
Dart	Swinger	3.2	1970-1972		HB471x.510	D11		
Dart	Swinger	3.7	1969-1972		HB471x.510	D11		
Dart	Swinger	4.5	1969-1969		HB471x.510	D11		
Dart	Swinger	5.2	1969-1972		HB471x.510	D11		
Dart	Swinger	5.6	1969-1971		HB471x.510	D11		
Dart		2.8	1966-1969		HB471x.510	D11		
Dart		3.2	1970-1972		HB471x.510	D11		
Dart		3.7	1966-1972		HB471x.510	D11		
Dart		4.5	1966-1969		HB471x.510	D11		
Dart		5.2	1967-1972		HB471x.510	D11		
Dart		5.6	1968-1968		HB471x.510	D11		
Dart		5.6	1970-1970		HB471x.510	D11		
Dart		6.3	1966-1968		HB471x.510	D11		
Daytona	ES	2.5	1991-1993	Drum	HB411x.717	D521		
Daytona	ES	3.0	1991-1993	Drum	HB411x.717	D521		
Daytona	Iroc	2.5	1991-1992		HB410x.721	D522	HB176x.614	D641
Daytona	Iroc	3.0	1991-1993		HB410x.721	D522	HB176x.614	D641
Daytona	Iroc R/T	2.2	1992-1993		HB410x.721	D522	HB176x.614	D641
Daytona	Shelby	2.5	1991-1991		HB410x.721	D522	HB176x.614	D641
Daytona		2.5	1991-1993	Drum	HB411x.717	D521		
Daytona		3.0	1991-1993	Drum	HB411x.717	D521		
Durango	Adventurer	4.7	2006-2006		HB300x.622	D758	HB513x.610	D967
Durango	Adventurer	4.7	2008-2008		HB559x.695	D1084	HB513x.610	D967
Durango	Adventurer	5.7	2006-2006		HB300x.622	D758	HB513x.610	D967
Durango	Adventurer	5.7	2008-2008		HB559x.695	D1084	HB513x.610	D967
Durango	Limited	4.7	2006-2006		HB300x.622	D758	HB513x.610	D967
Durango	Limited	4.7	2008-2008		HB559x.695	D1084	HB513x.610	D967
Durango	Limited	5.7	2006-2006		HB300x.622	D758	HB513x.610	D967
Durango	Limited	5.7	2008-2008		HB559x.695	D1084	HB513x.610	D967
Durango	SLT	3.7	2006-2006		HB300x.622	D758	HB513x.610	D967
Durango	SLT	3.7	2008-2008		HB559x.695	D1084	HB513x.610	D967
Durango	SLT	4.7	2006-2006		HB300x.622	D758	HB513x.610	D967
Durango	SLT	4.7	2008-2008		HB559x.695	D1084	HB513x.610	D967
Durango	SLT	5.7	2006-2006		HB300x.622	D758	HB513x.610	D967
Durango	SLT	5.7	2008-2008		HB559x.695	D1084	HB513x.610	D967
Durango	SXT	3.7	2006-2006		HB300x.622	D758	HB513x.610	D967
Durango	SXT	3.7	2008-2008		HB559x.695	D1084	HB513x.610	D967
Durango	SXT	4.7	2006-2006		HB300x.622	D758	HB513x.610	D967
Durango	SXT	4.7	2008-2008		HB559x.695	D1084	HB513x.610	D967
Durango		3.7	2004-2005		HB300x.622	D758	HB513x.610	D967

CODE Breakdown

HB 245 x .631

Insert Compound Code

Make/Model	Submodel	Engine (Liter)	Years	Note	FRONT		REAR	
					Hawk #	FMSI	Hawk #	FMSI
DODGE CONT.								
Durango		3.9	1998-1999		HB306x.795	D746		
Durango		4.7	2000-2002		HB307x.795	D820		
Durango		4.7	2003-2005		HB300x.622	D758	HB513x.610	D967
Durango		5.2	1998-1999		HB306x.795	D746		
Durango		5.2	2000-2000		HB307x.795	D820		
Durango		5.7	2004-2005		HB300x.622	D758	HB513x.610	D967
Durango		5.9	1998-1999		HB306x.795	D746		
Durango		5.9	2000-2002		HB307x.795	D820		
Durango		5.9	2003-2003		HB300x.622	D758	HB513x.610	D967
Dynasty	LE	3.0	1991-1993		HB411x.717	D521	HB176x.614	D641
Dynasty	LE	3.3	1991-1993		HB411x.717	D521	HB176x.614	D641
Dynasty		2.5	1991-1993		HB411x.717	D521	HB176x.614	D641
Dynasty		3.0	1991-1993		HB411x.717	D521	HB176x.614	D641
Dynasty		3.3	1991-1993		HB411x.717	D521	HB176x.614	D641
Grand Caravan	ES	3.0	1993-1993	AWD	HB410x.721	D522		
Grand Caravan	ES	3.0	1993-1993	FWD	HB411x.717	D521		
Grand Caravan	ES	3.3	1993-1994	AWD	HB410x.721	D522		
Grand Caravan	ES	3.3	1993-1995	FWD	HB411x.717	D521		
Grand Caravan	ES	3.3	1996-1997		HB177x.710	D642		
Grand Caravan	ES	3.3	2001-2001	Drum	HB373x.689	D844		
Grand Caravan	ES	3.3	2001-2001	Disc	HB374x.700	D857	HB372x.626	D858
Grand Caravan	ES	3.8	1994-1994	AWD	HB410x.721	D522		
Grand Caravan	ES	3.8	1994-1995	FWD	HB411x.717	D521		
Grand Caravan	ES	3.8	1996-1997		HB177x.710	D642		
Grand Caravan	ES	3.8	2001-2001	Drum	HB373x.689	D844		
Grand Caravan	ES	3.8	2001-2001	Disc	HB374x.700	D857	HB372x.626	D858
Grand Caravan	LE	3.0	1992-1992	AWD	HB410x.721	D522		
Grand Caravan	LE	3.0	1992-1992	FWD	HB411x.717	D521		
Grand Caravan	LE	3.3	1991-1991	AWD	HB410x.721	D522		
Grand Caravan	LE	3.3	1991-1991	FWD	HB411x.717	D521		
Grand Caravan	LE	3.3	1993-1994	AWD	HB410x.721	D522		
Grand Caravan	LE	3.3	1993-1995	FWD	HB411x.717	D521		
Grand Caravan	LE	3.3	1996-1997		HB177x.710	D642		
Grand Caravan	LE	3.8	1994-1994	AWD	HB410x.721	D522		
Grand Caravan	LE	3.8	1994-1995	FWD	HB411x.717	D521		
Grand Caravan	LE	3.8	1996-1997		HB177x.710	D642		
Grand Caravan	SE	2.4	1996-1997		HB177x.710	D642		
Grand Caravan	SE	3.0	1992-1992	AWD	HB410x.721	D522		
Grand Caravan	SE	3.0	1992-1992	FWD	HB411x.717	D521		
Grand Caravan	SE	3.0	1994-1994	AWD	HB410x.721	D522		
Grand Caravan	SE	3.0	1994-1995	FWD	HB411x.717	D521		
Grand Caravan	SE	3.0	1996-1997		HB177x.710	D642		
Grand Caravan	SE	3.3	1991-1994	AWD	HB410x.721	D522		
Grand Caravan	SE	3.3	1991-1995	FWD	HB411x.717	D521		
Grand Caravan	SE	3.3	1996-1997		HB177x.710	D642		
Grand Caravan	SE	3.3	2001-2001	Drum	HB373x.689	D844		
Grand Caravan	SE	3.3	2006-2007		HB374x.700	D857	HB372x.626	D858
Grand Caravan	SE	3.8	1997-1997		HB177x.710	D642		
Grand Caravan	Sport	3.3	2001-2003	Drum	HB373x.689	D844		
Grand Caravan	Sport	3.3	2001-2003	Disc	HB374x.700	D857	HB372x.626	D858
Grand Caravan	Sport	3.8	2001-2001	Drum	HB373x.689	D844		
Grand Caravan	Sport	3.8	2001-2001	Disc	HB374x.700	D857	HB372x.626	D858

RACE COMPOUND CODES

DTC-70 - U | DTC-05 - H | MT-4 - L | DR-97 - J
 DTC-60 - G | HT-14 - V | Blue 9012 - E | HP Plus - N
 DTC-30 - W | HT-10 - S | Black - M

STREET COMPOUND CODES

HPS Performance Street - F | SuperDuty - P
 Performance Ceramic - Z
 LTS Light Truck & SUV - Y

Make/Model	Submodel	Engine (Liter)	Years	Note	FRONT		REAR	
					Hawk #	FMSI	Hawk #	FMSI
DODGE CONT.								
Grand Caravan	Sport	3.8	2003-2003	Drum	HB373x.689	D844		
Grand Caravan	Sport	3.8	2003-2003	Disc	HB374x.700	D857	HB372x.626	D858
Grand Caravan	SXT	3.8	2006-2007		HB374x.700	D857	HB372x.626	D858
Grand Caravan		2.4	1996-1997		HB177x.710	D642		
Grand Caravan		3.0	1994-1994	AWD	HB410x.721	D522		
Grand Caravan		3.0	1994-1995	FWD	HB411x.717	D521		
Grand Caravan		3.0	1996-2000		HB177x.710	D642		
Grand Caravan		3.3	1992-1992	AWD	HB410x.721	D522		
Grand Caravan		3.3	1992-1992	FWD	HB411x.717	D521		
Grand Caravan		3.3	1997-2000		HB177x.710	D642		
Grand Caravan		3.3	2002-2003	Disc	HB374x.700	D857	HB372x.626	D858
Grand Caravan		3.3	2002-2005	Drum	HB373x.689	D844		
Grand Caravan		3.3	2005-2005	Disc	HB374x.700	D857	HB372x.626	D858
Grand Caravan		3.3	2006-2007		HB374x.700	D857	HB372x.626	D858
Grand Caravan		3.8	1998-2000		HB177x.710	D642		
Grand Caravan		3.8	2001-2003	Drum	HB373x.689	D844		
Grand Caravan		3.8	2001-2003	Disc	HB374x.700	D857	HB372x.626	D858
Grand Caravan		3.8	2004-2004		HB374x.700	D857	HB372x.626	D858
Grand Caravan		3.8	2005-2005	Disc	HB374x.700	D857	HB372x.626	D858
Intrepid	ES	2.7	2000-2001		HB260x.670	D730	HB176x.614	D641
Intrepid	ES	3.2	2000-2000		HB260x.670	D730	HB176x.614	D641
Intrepid	ES	3.3	1993-1994		HB241x.710	D591	HB176x.614	D641
Intrepid	ES	3.3	1995-1995		HB177x.710	D642	HB176x.614	D641
Intrepid	ES	3.5	1993-1994		HB241x.710	D591	HB176x.614	D641
Intrepid	ES	3.5	1995-1997		HB177x.710	D642	HB176x.614	D641
Intrepid	ES	3.5	2002-2004		HB260x.670	D730	HB176x.614	D641
Intrepid	Police	3.5	2004-2004		HB260x.670	D730	HB176x.614	D641
Intrepid	R/T	3.5	2000-2000		HB260x.670	D730	HB176x.614	D641
Intrepid	R/T	3.5	2002-2002		HB260x.670	D730		
Intrepid	SE	2.7	2002-2004		HB260x.670	D730	HB176x.614	D641
Intrepid	SE	3.5	2002-2003		HB260x.670	D730	HB176x.614	D641
Intrepid	SXT	3.5	2003-2004		HB260x.670	D730	HB176x.614	D641
Intrepid		2.7	1998-2001		HB260x.670	D730	HB176x.614	D641
Intrepid		3.2	1998-1999		HB260x.670	D730	HB176x.614	D641
Intrepid		3.2	2001-2001		HB260x.670	D730	HB176x.614	D641
Intrepid		3.3	1993-1994		HB241x.710	D591	HB176x.614	D641
Intrepid		3.3	1995-1997		HB177x.710	D642	HB176x.614	D641
Intrepid		3.5	1993-1994		HB241x.710	D591	HB176x.614	D641
Intrepid		3.5	1995-1997		HB177x.710	D642	HB176x.614	D641
Intrepid		3.5	2001-2001		HB260x.670	D730	HB176x.614	D641
Magnum	R/T	5.7	2005-2008	RWD	HB507x.711	D1056	HB508x.586	D1057
Magnum	R/T	5.7	2005-2008	RWD	HB507x.711	D1056	HB508x.675	D1057
Magnum	R/T	5.7	2005-2008	AWD	HB509x.678	D1058	HB508x.586	D1057
Magnum	R/T	5.7	2005-2008	AWD	HB509x.678	D1058	HB508x.675	D1057
Magnum	SE	2.7	2005-2008		HB507x.711	D1056	HB508x.675	D1057
Magnum	SE	3.5	2007-2008		HB507x.711	D1056	HB508x.586	D1057
Magnum	SE	3.5	2007-2008		HB507x.711	D1056	HB508x.675	D1057
Magnum	SRT-8	6.1	2006-2007		HB563x.656	D1149	HB194x.570	D592
Magnum	SXT	3.5	2005-2008	RWD	HB507x.711	D1056	HB508x.675	D1057
Magnum	SXT	3.5	2005-2008	AWD	HB509x.678	D1058	HB508x.675	D1057
Magnum	SXT Special Edition	3.5	2005-2005		HB507x.711	D1056	HB508x.675	D1057
Neon	ACR	2.0	2002-2002		HB260x.670	D730	HB176x.614	D641
Neon	ES	2.0	2002-2002		HB260x.670	D730	HB176x.614	D641

CODE Breakdown

HB 245 x .631

Insert Compound Code

Make/Model	Submodel	Engine (Liter)	Years	Note	FRONT		REAR	
					Hawk #	FMSI	Hawk #	FMSI
DODGE CONT.								
Neon	Highline	2.0	1995-1997		HB177x.630	D642	HB176x.614	D641
Neon	R/T	2.0	2001-2004		HB260x.670	D730	HB176x.614	D641
Neon	SE	2.0	2002-2004		HB260x.670	D730	HB176x.614	D641
Neon	Sport	2.0	1995-1997		HB177x.630	D642	HB176x.614	D641
Neon	SRT-4	2.4	2003-2005		HB377x.760	D841	HB176x.614	D641
Neon	SXT	2.0	2003-2004		HB260x.670	D730	HB176x.614	D641
Neon		2.0	1995-1999		HB177x.630	D642	HB176x.614	D641
Neon		2.0	2000-2001		HB260x.670	D730	HB176x.614	D641
Nitro	R/T	4.0	2007-2008		HB569x.650	D1273		
Nitro	SLT	3.7	2007-2008		HB569x.650	D1273		
Nitro	SXT	3.7	2007-2008		HB569x.650	D1273		
Raider		2.6	1988-1988		HB404x.642	D349		
Ram 1500 Pickup	Laramie	4.7	2006-2006	Full Crew Cab	HB552x.722	D965	HB513x.610	D967
Ram 1500 Pickup	Laramie	4.7	2006-2006	Crew Cab, Regular Cab	HB559x.695	D1084	HB513x.610	D967
Ram 1500 Pickup	Laramie	5.7	2006-2007	Full Crew Cab	HB552x.722	D965	HB513x.610	D967
Ram 1500 Pickup	Laramie	5.7	2006-2007	Crew Cab, Regular Cab	HB559x.695	D1084	HB513x.610	D967
Ram 1500 Pickup	Laramie	5.7	2008-2008	Crew Cab	HB552x.722	D965		
Ram 1500 Pickup	Laramie	5.7	2008-2008	Regular Cab	HB559x.695	D1084		
Ram 1500 Pickup	SLT	4.7	2006-2007		HB559x.695	D1084	HB513x.610	D967
Ram 1500 Pickup	SLT	4.7	2008-2008	Crew Cab	HB552x.722	D965	HB513x.610	D967
Ram 1500 Pickup	SLT	4.7	2008-2008	Regular Cab	HB559x.695	D1084	HB513x.610	D967
Ram 1500 Pickup	SLT	5.7	2006-2007		HB559x.695	D1084	HB513x.610	D967
Ram 1500 Pickup	SLT	5.7	2008-2008	Crew Cab	HB552x.722	D965	HB513x.610	D967
Ram 1500 Pickup	SLT	5.7	2008-2008	Regular Cab	HB559x.695	D1084	HB513x.610	D967
Ram 1500 Pickup	Sport	5.7	2006-2007		HB559x.695	D1084	HB513x.610	D967
Ram 1500 Pickup	Sport	5.7	2008-2008	Crew Cab	HB552x.722	D965	HB513x.610	D967
Ram 1500 Pickup	Sport	5.7	2008-2008	Regular Cab	HB559x.695	D1084	HB513x.610	D967
Ram 1500 Pickup	ST	3.7	2006-2007		HB559x.695	D1084	HB513x.610	D967
Ram 1500 Pickup	ST	3.7	2008-2008	Crew Cab	HB552x.722	D965	HB513x.610	D967
Ram 1500 Pickup	ST	3.7	2008-2008	Regular Cab	HB559x.695	D1084	HB513x.610	D967
Ram 1500 Pickup	ST	4.7	2006-2007		HB559x.695	D1084	HB513x.610	D967
Ram 1500 Pickup	ST	4.7	2008-2008	Crew Cab	HB552x.722	D965	HB513x.610	D967
Ram 1500 Pickup	ST	4.7	2008-2008	Regular Cab	HB559x.695	D1084	HB513x.610	D967
Ram 1500 Pickup	ST	5.7	2006-2007		HB559x.695	D1084	HB513x.610	D967
Ram 1500 Pickup	ST	5.7	2008-2008	Crew Cab	HB552x.722	D965	HB513x.610	D967
Ram 1500 Pickup	ST	5.7	2008-2008	Regular Cab	HB559x.695	D1084	HB513x.610	D967
Ram 1500 Pickup	SXT	3.7	2008-2008	Crew Cab	HB552x.722	D965	HB513x.610	D967
Ram 1500 Pickup	SXT	3.7	2008-2008	Regular Cab	HB559x.695	D1084	HB513x.610	D967
Ram 1500 Pickup	SXT	4.7	2008-2008	Crew Cab	HB552x.722	D965	HB513x.610	D967
Ram 1500 Pickup	SXT	4.7	2008-2008	Regular Cab	HB559x.695	D1084	HB513x.610	D967
Ram 1500 Pickup	SXT	5.7	2008-2008	Crew Cab	HB552x.722	D965	HB513x.610	D967
Ram 1500 Pickup	SXT	5.7	2008-2008	Regular Cab	HB559x.695	D1084	HB513x.610	D967
Ram 1500 Pickup		3.7	2003-2005		HB300x.622	D758	HB513x.610	D967
Ram 1500 Pickup		3.9	1994-1999		HB332x.654	D369		
Ram 1500 Pickup		3.9	2000-2001		HB300x.622	D758		
Ram 1500 Pickup		4.7	2003-2005		HB300x.622	D758	HB513x.610	D967
Ram 1500 Pickup		5.2	1994-1999		HB332x.654	D369		
Ram 1500 Pickup		5.2	2000-2001		HB300x.622	D758		
Ram 1500 Pickup		5.7	2003-2005		HB300x.622	D758	HB513x.610	D967
Ram 1500 Pickup		5.9	1994-1999		HB332x.654	D369		
Ram 1500 Pickup		5.9	2000-2001		HB300x.622	D758		
Ram 1500 Pickup		5.9	2003-2003		HB300x.622	D758	HB513x.610	D967
Ram 1500 Van		3.9	1999-2002		HB300x.622	D758		

RACE COMPOUND CODES

DTC-70 - U	DTC-05 - H	MT-4 - L	DR-97 - J
DTC-60 - G	HT-14 - V	Blue 9012 - E	HP Plus - N
DTC-30 - W	HT-10 - S	Black - M	

STREET COMPOUND CODES

HPS Performance Street - F	SuperDuty - P
Performance Ceramic - Z	
LTS Light Truck & SUV - Y	

Make/Model	Submodel	Engine (Liter)	Years	Note	FRONT		REAR	
					Hawk #	FMSI	Hawk #	FMSI
DODGE CONT.								
Ram 1500 Van		3.9	2003-2003		HB300x.622	D758	HB514x.610	D898
Ram 1500 Van		5.2	1999-2002		HB300x.622	D758		
Ram 1500 Van		5.2	2003-2003		HB300x.622	D758	HB514x.610	D898
Ram 1500 Van		5.9	1999-2002		HB300x.622	D758		
Ram 1500 Van		5.9	2003-2003		HB300x.622	D758	HB514x.610	D898
Ram 2500 Pickup	Club Cab	5.9	1998-1998		HB298x.787	D459		
Ram 2500 Pickup	Laramie	5.7	2006-2008		HB552x.722	D965		
Ram 2500 Pickup	Laramie	5.9	2006-2007		HB552x.722	D965		
Ram 2500 Pickup	Laramie	6.7	2007-2008		HB552x.722	D965		
Ram 2500 Pickup	Power Wagon	5.7	2006-2008		HB552x.722	D965		
Ram 2500 Pickup	Quad Cab	5.9	1998-1998		HB298x.787	D459		
Ram 2500 Pickup	Quad Cab	5.9	2001-2001		HB487x.733	D821		
Ram 2500 Pickup	SLT	5.7	2006-2008		HB552x.722	D965		
Ram 2500 Pickup	SLT	5.9	2006-2007		HB552x.722	D965		
Ram 2500 Pickup	SLT	6.7	2007-2008		HB552x.722	D965		
Ram 2500 Pickup	Sport	5.7	2006-2007		HB552x.722	D965		
Ram 2500 Pickup	Sport	5.9	2006-2007		HB552x.722	D965		
Ram 2500 Pickup	ST	5.7	2006-2008		HB552x.722	D965		
Ram 2500 Pickup	ST	5.9	2006-2008		HB552x.722	D965		
Ram 2500 Pickup	ST	6.7	2007-2008		HB552x.722	D965		
Ram 2500 Pickup	SXT	5.7	2008-2008		HB552x.722	D965		
Ram 2500 Pickup	SXT	6.7	2008-2008		HB552x.722	D965		
Ram 2500 Pickup	TRX4	5.7	2006-2007		HB552x.722	D965		
Ram 2500 Pickup	TRX4	5.9	2006-2007		HB552x.722	D965		
Ram 2500 Pickup		5.2	1994-1996	7500 lbs. GVW, w/3500 lbs. Floating Axle	HB296x.670	D370		
Ram 2500 Pickup		5.2	1994-1996	8800 lbs. GVWR, w/4500 lbs. Floating Axle	HB298x.787	D459		
Ram 2500 Pickup		5.7	2003-2005		HB552x.722	D965		
Ram 2500 Pickup		5.9	1994-1997	7500 lbs. GVW, w/3500 lbs. Floating Axle	HB296x.670	D370		
Ram 2500 Pickup		5.9	1994-1997	8800 lbs. GVWR, w/4500 lbs. Floating Axle	HB298x.787	D459		
Ram 2500 Pickup		5.9	1998-1999		HB298x.787	D459		
Ram 2500 Pickup		5.9	2000-2002		HB487x.733	D821		
Ram 2500 Pickup		5.9	2003-2005		HB552x.722	D965		
Ram 2500 Pickup		8.0	1994-1997	7500 lbs. GVW, w/3500 lbs. Floating Axle	HB296x.670	D370		
Ram 2500 Pickup		8.0	1994-1997	8800 lbs. GVWR, w/4500 lbs. Floating Axle	HB298x.787	D459		
Ram 2500 Pickup		8.0	1998-1999		HB298x.787	D459		
Ram 2500 Pickup		8.0	2000-2002		HB487x.733	D821		
Ram 2500 Pickup		8.0	2003-2003		HB552x.722	D965		
Ram 2500 Van		3.9	2001-2001		HB334x.705	D655		
Ram 2500 Van		5.2	1999-2003		HB334x.705	D655		
Ram 2500 Van		5.9	1999-2003		HB334x.705	D655		
Ram 3500 Pickup	Laramie	5.7	2006-2006		HB552x.722	D965		
Ram 3500 Pickup	Laramie	5.7	2007-2007	Full Crew Cab	HB552x.722	D965		
Ram 3500 Pickup	Laramie	5.7	2008-2008		HB552x.722	D965		
Ram 3500 Pickup	Laramie	5.9	2006-2006		HB552x.722	D965		
Ram 3500 Pickup	Laramie	5.9	2007-2007	Full Crew Cab	HB552x.722	D965		
Ram 3500 Pickup	Laramie	6.7	2007-2007	Full Crew Cab	HB552x.722	D965		
Ram 3500 Pickup	Laramie	6.7	2008-2008		HB552x.722	D965		
Ram 3500 Pickup	Quad Cab	5.9	1998-1998		HB298x.787	D459		
Ram 3500 Pickup	Quad Cab	5.9	2001-2001		HB487x.733	D821		
Ram 3500 Pickup	SLT	5.7	2006-2008		HB552x.722	D965		
Ram 3500 Pickup	SLT	5.9	2006-2007		HB552x.722	D965		
Ram 3500 Pickup	SLT	6.7	2007-2008		HB552x.722	D965		

CODE Breakdown

HB 245 x .631

Insert Compound Code

Make/Model	Submodel	Engine (Liter)	Years	Note	FRONT		REAR	
					Hawk #	FMSI	Hawk #	FMSI
DODGE CONT.								
Ram 3500 Pickup	Sport	5.7	2006-2006		HB552x.722	D965		
Ram 3500 Pickup	Sport	5.9	2006-2006		HB552x.722	D965		
Ram 3500 Pickup	ST	5.7	2006-2008		HB552x.722	D965		
Ram 3500 Pickup	ST	5.9	2006-2008		HB552x.722	D965		
Ram 3500 Pickup	ST	6.7	2007-2008		HB552x.722	D965		
Ram 3500 Pickup	SXT	5.7	2008-2008		HB552x.722	D965		
Ram 3500 Pickup	SXT	6.7	2008-2008		HB552x.722	D965		
Ram 3500 Pickup		5.7	2003-2005		HB552x.722	D965		
Ram 3500 Pickup		5.9	1994-1999		HB298x.787	D459		
Ram 3500 Pickup		5.9	2000-2002		HB487x.733	D821		
Ram 3500 Pickup		5.9	2003-2005		HB552x.722	D965		
Ram 3500 Pickup		8.0	1994-1999		HB298x.787	D459		
Ram 3500 Pickup		8.0	2000-2002		HB487x.733	D821		
Ram 3500 Pickup		8.0	2003-2003		HB552x.722	D965		
Ram 3500 Van		5.2	1999-2003		HB334x.705	D655		
Ram 3500 Van		5.9	1999-2003		HB334x.705	D655		
Ram 50	Custom	2.6	1987-1989		HB404x.642	D349		
Ram 50	SE	2.4	1990-1993		HB404x.642	D349		
Ram 50	SE	3.0	1991-1991		HB404x.642	D349		
Ram 50	Sport	2.6	1987-1989		HB404x.642	D349		
Ram 50		2.0	1987-1989		HB404x.642	D349		
Ram 50		2.4	1990-1993		HB404x.642	D349		
Ram 50		2.6	1987-1989		HB404x.642	D349		
Ram 50		3.0	1990-1991		HB404x.642	D349		
Shadow	America	2.2	1991-1992		HB411x.717	D521		
Shadow	America	2.5	1992-1992		HB411x.717	D521		
Shadow	ES	2.5	1991-1994		HB411x.717	D521		
Shadow	ES	3.0	1992-1994		HB411x.717	D521		
Shadow		2.2	1991-1994		HB411x.717	D521		
Shadow		2.5	1991-1994		HB411x.717	D521		
Shadow		3.0	1993-1993		HB411x.717	D521	HB176x.614	D641
Spirit	ES	2.5	1991-1991		HB410x.721	D522	HB176x.614	D641
Spirit	ES	2.5	1992-1993	Disc	HB410x.721	D522	HB176x.614	D641
Spirit	ES	2.5	1992-1993	Drum	HB411x.717	D521		
Spirit	ES	3.0	1991-1991		HB410x.721	D522	HB176x.614	D641
Spirit	ES	3.0	1992-1993	Disc	HB410x.721	D522	HB176x.614	D641
Spirit	ES	3.0	1992-1993	Drum	HB411x.717	D521		
Spirit	LE	2.5	1991-1992	Drum	HB411x.717	D521		
Spirit	LE	2.5	1992-1992	Disc	HB410x.721	D522	HB176x.614	D641
Spirit	LE	3.0	1991-1992	Drum	HB411x.717	D521		
Spirit	LE	3.0	1992-1992	Disc	HB410x.721	D522	HB176x.614	D641
Spirit	R/T	2.2	1991-1991		HB410x.721	D522	HB176x.614	D641
Spirit	R/T	2.2	1992-1992	Disc	HB410x.721	D522	HB176x.614	D641
Spirit	R/T	2.2	1992-1992	Drum	HB411x.717	D521		
Spirit		2.5	1991-1994	Drum	HB411x.717	D521		
Spirit		2.5	1992-1993	Disc	HB410x.721	D522	HB176x.614	D641
Spirit		3.0	1991-1994	Drum	HB411x.717	D521		
Spirit		3.0	1992-1993	Disc	HB410x.721	D522	HB176x.614	D641
Sprinter 2500		2.7	2003-2003		HB575x.750	D1136		
Sprinter 2500		2.7	2004-2004	15 in. Wheel	HB480x.750	D949	HB479x.700	D928
Sprinter 2500		2.7	2004-2004	16 in. Wheel	HB575x.750	D1136	HB479x.700	D928
Sprinter 2500		2.7	2005-2005		HB575x.750	D1136	HB479x.700	D928

RACE COMPOUND CODES

DTC-70 - U	DTC-05 - H	MT-4 - L	DR-97 - J
DTC-60 - G	HT-14 - V	Blue 9012 - E	HP Plus - N
DTC-30 - W	HT-10 - S	Black - M	

STREET COMPOUND CODES

HPS Performance Street - F	SuperDuty - P
Performance Ceramic - Z	
LTS Light Truck & SUV - Y	

Make/Model	Submodel	Engine (Liter)	Years	Note	FRONT		REAR	
					Hawk #	FMSI	Hawk #	FMSI
DODGE CONT.								
Sprinter 2500		2.7	2006-2006	15 in. Wheels. w/Bosch Calipers	HB480x.750	D949	HB479x.700	D928
Sprinter 2500		2.7	2006-2006	16 in. Wheels. w/Teves Calipers	HB480x.750	D949	HB481x.750	D1006
Sprinter 2500		2.7	2006-2006	15 in. Wheels. w/Bosch Calipers	HB575x.750	D1136	HB479x.700	D928
Sprinter 2500		2.7	2006-2006	16 in. Wheels. w/Teves Calipers	HB575x.750	D1136	HB481x.750	D1006
Sprinter 3500		2.7	2004-2004		HB480x.750	D949	HB575x.750	D1136
Sprinter 3500		2.7	2006-2006	15 in. Wheels. w/Bosch Calipers	HB480x.750	D949	HB479x.700	D928
Sprinter 3500		2.7	2006-2006	16 in. Wheels. w/Teves Calipers	HB480x.750	D949	HB481x.750	D1006
Sprinter 3500		2.7	2006-2006	15 in. Wheels. w/Bosch Calipers	HB575x.750	D1136	HB479x.700	D928
Sprinter 3500		2.7	2006-2006	16 in. Wheels. w/Teves Calipers	HB575x.750	D1136	HB481x.750	D1006
Stealth	ES	3.0	1991-1993		HB214x.618	D530	HB367x.585	D383
Stealth	R/T	3.0	1991-1993		HB214x.618	D530	HB367x.585	D383
Stealth	R/T	3.0	1996-1996		HB214x.618	D530	HB367x.585	D383
Stealth	R/T Sport	3.0	1994-1995		HB214x.618	D530	HB367x.585	D383
Stealth	R/T Turbo	3.0	1991-1993		HB120x.560	D531		
Stealth	R/T Turbo	3.0	1994-1994	AWD	HB120x.560	D531	HB367x.585	D383
Stealth	R/T Turbo	3.0	1994-1994	FWD	HB214x.618	D530	HB367x.585	D383
Stealth	R/T Turbo	3.0	1995-1996		HB120x.560	D531	HB201x.620	D631
Stealth		3.0	1991-1993		HB214x.618	D530	HB367x.585	D383
Stealth		3.0	1994-1994	AWD, FWD	HB214x.618	D530	HB367x.585	D383
Stealth		3.0	1995-1996		HB214x.618	D530	HB367x.585	D383
Stratus	ES	2.0	1995-1997		HB233x.635	D650	HB176x.614	D641
Stratus	ES	2.4	1995-1998		HB233x.635	D650	HB176x.614	D641
Stratus	R/T	2.7	2002-2002	Coupe (2 Door)	HB435x.622	D866	HB367x.585	D383
Stratus	R/T	2.7	2002-2002	Sedan (4 Door)	HB498x.772	D869	HB176x.614	D641
Stratus	R/T	2.7	2004-2004	Coupe (2 Door)	HB435x.622	D866	HB367x.585	D383
Stratus	R/T	2.7	2004-2004	Sedan (4 Door)	HB498x.772	D869	HB176x.614	D641
Stratus	R/T	3.0	2002-2005	Coupe (2 Door)	HB435x.622	D866	HB367x.585	D383
Stratus	R/T	3.0	2002-2005	Sedan (4 Door)	HB498x.772	D869	HB176x.614	D641
Stratus	SXT	2.4	2006-2006		HB498x.772	D869	HB176x.614	D641
Stratus	SXT	2.7	2006-2006		HB498x.772	D869	HB176x.614	D641
Stratus		2.0	1995-1998		HB233x.635	D650		
Stratus		2.0	1999-2000		HB233x.635	D650	HB176x.614	D641
Stratus		2.4	1995-1998		HB233x.635	D650		
Stratus		2.4	1999-2000		HB233x.635	D650	HB176x.614	D641
Stratus		2.4	2001-2005	Coupe (2 Door)	HB435x.622	D866	HB367x.585	D383
Stratus		2.4	2001-2005	Sedan (4 Door)	HB498x.772	D869	HB176x.614	D641
Stratus		2.5	1999-2000		HB233x.635	D650	HB176x.614	D641
Stratus		2.7	2001-2005	Coupe (2 Door)	HB435x.622	D866	HB367x.585	D383
Stratus		2.7	2001-2005	Sedan (4 Door)	HB498x.772	D869	HB176x.614	D641
Stratus		3.0	2001-2002	Coupe (2 Door)	HB435x.622	D866	HB367x.585	D383
Stratus		3.0	2001-2002	Sedan (4 Door)	HB498x.772	D869	HB176x.614	D641
Viper	GTS	8.0	1996-1996		HB194x.665	D592	HB278x.583	D491
Viper	GTS	8.0	2000-2000		HB194x.665	D592	HB278x.583	D491
Viper	GTS	8.0	2001-2002		HB194x.665	D592		
Viper	RT10	8.0	2000-2000		HB194x.665	D592	HB278x.583	D491
Viper	RT10	8.0	2001-2002		HB194x.665	D592		
Viper	SRT10	8.3	2003-2005		HB193x.670	D810	HB193x.670	D810
Viper	SRT-10	8.3	2006-2006		HB193x.670	D810	HB193x.670	D810
Viper	SRT-10	8.4	2008-2008		HB193x.670	D810	HB193x.670	D810
Viper		8.0	1992-2000		HB194x.665	D592	HB278x.583	D491
Viper		8.0	2001-2002		HB194x.665	D592		
W100 Pickup		3.7	1986-1987		HB398x.680	D269		

CODE Breakdown

HB 245 x .631

Insert Compound Code

Make/Model	Submodel	Engine (Liter)	Years	Note	FRONT		REAR	
					Hawk #	FMSI	Hawk #	FMSI
DODGE CONT.								
W100 Pickup		3.9	1989-1989		HB398x.680	D269		
W100 Pickup		5.2	1986-1989		HB398x.680	D269		
W100 Pickup		5.9	1986-1988		HB398x.680	D269		
W150 Pickup	S	3.9	1990-1991		HB398x.680	D269		
W150 Pickup	S	5.2	1990-1991		HB398x.680	D269		
W150 Pickup	S	5.9	1991-1991		HB398x.680	D269		
W150 Pickup		3.7	1984-1987		HB398x.680	D269		
W150 Pickup		3.9	1989-1993		HB398x.680	D269		
W150 Pickup		5.2	1984-1993		HB398x.680	D269		
W150 Pickup		5.9	1984-1991		HB398x.680	D269		
W150 Pickup		5.9	1993-1993		HB398x.680	D269		
W250 Pickup		5.2	1984-1993	w/4500 lbs. Floating Axle	HB337x.791	D149		
W250 Pickup		5.2	1984-1993	w/3800 lbs. Front Axle	HB398x.680	D269		
W250 Pickup		5.9	1984-1993	w/4500 lbs. Floating Axle	HB337x.791	D149		
W250 Pickup		5.9	1984-1993	w/3800 lbs. Front Axle	HB398x.680	D269		
W350 Pickup		5.2	1982-1983		HB337x.791	D149		
W350 Pickup		5.9	1982-1993		HB337x.791	D149		
EAGLE								
Summit	DL	1.5	1993-1996		HB230x.575	D602		
Summit	DL	1.8	1992-1996		HB230x.575	D602		
Summit	DL	2.4	1992-1996		HB230x.575	D602		
Summit	ES	1.5	1991-1992		HB230x.575	D602		
Summit	ES	1.5	1993-1994		HB230x.575	D602	HB367x.585	D383
Summit	ES	1.5	1996-1996		HB230x.575	D602		
Summit	ES	1.8	1993-1994		HB230x.575	D602	HB367x.585	D383
Summit	ES	1.8	1996-1996		HB230x.575	D602		
Summit	ESi	1.5	1995-1996		HB230x.575	D602	HB367x.585	D383
Summit	ESi	1.8	1994-1995		HB230x.575	D602	HB367x.585	D383
Summit	LX	1.8	1992-1992		HB230x.575	D602		
Summit	LX	1.8	1994-1995		HB230x.575	D602	HB367x.585	D383
Summit	LX	1.8	1996-1996		HB230x.575	D602		
Summit	LX	2.4	1992-1993		HB230x.575	D602		
Summit	LX	2.4	1994-1995		HB230x.575	D602	HB367x.585	D383
Summit		1.5	1991-1992		HB230x.575	D602		
Summit		1.8	1992-1993		HB230x.575	D602		
Summit		2.4	1992-1996		HB230x.575	D602		
Talon	TSi	2.0	1990-1991		HB213x.626	D484		
Talon	TSi	2.0	1993-1997		HB214x.618	D530		
Talon	TSi	2.0	1996-1998		HB214x.618	D530	HB367x.585	D383
Vision	ESi	3.3	1993-1994		HB241x.710	D591	HB176x.614	D641
Vision	ESi	3.3	1995-1997		HB177x.710	D642	HB176x.614	D641
Vision	ESi	3.5	1995-1997		HB177x.710	D642	HB176x.614	D641
Vision	TSi	3.5	1993-1994		HB241x.710	D591	HB176x.614	D641
Vision	TSi	3.5	1995-1997		HB177x.710	D642	HB176x.614	D641
FERRARI								
F355		3.5	1999-1999		HB170x.650	D345	HB170x.650	D345
F40		2.9	1990-1992		HB193x.670	D810	HB193x.670	D810
F50		4.7	1995-1997		HB193x.670	D810	HB193x.670	D810
FORD								
Aerostar		2.3	1987-1987		HB279x.594	D249		
Aerostar		3.0	1987-1997		HB279x.594	D249		

RACE COMPOUND CODES

DTC-70 - U	DTC-05 - H	MT-4 - L	DR-97 - J
DTC-60 - G	HT-14 - V	Blue 9012 - E	HP Plus - N
DTC-30 - W	HT-10 - S	Black - M	

STREET COMPOUND CODES

HPS Performance Street - F	SuperDuty - P
Performance Ceramic - Z	
LTS Light Truck & SUV - Y	

Make/Model	Submodel	Engine		Note	FRONT		REAR	
		(Liter)	Years		Hawk #	FMSI	Hawk #	FMSI
FORD CONT.								
Aerostar		4.0	1990-1997		HB279x.594	D249		
Bronco		4.9	1980-1986		HB292x.674	D50		
Bronco		4.9	1988-1989		HB293x.634	D375		
Bronco		4.9	1990-1992		HB293x.668	D375		
Bronco		5.0	1977-1977		HB292x.674	D50		
Bronco		5.0	1980-1986		HB292x.674	D50		
Bronco		5.0	1988-1989		HB293x.634	D375		
Bronco		5.0	1990-1993		HB293x.668	D375		
Bronco		5.0	1994-1996		HB295x.630	D632		
Bronco		5.8	1978-1986		HB292x.674	D50		
Bronco		5.8	1988-1989		HB293x.634	D375		
Bronco		5.8	1990-1993		HB293x.668	D375		
Bronco		5.8	1994-1996		HB295x.630	D632		
Bronco		6.6	1978-1979		HB292x.674	D50		
Bronco II		2.3	1985-1987		HB279x.594	D249		
Bronco II		2.8	1984-1985		HB279x.594	D249		
Bronco II		2.9	1986-1990		HB279x.594	D249		
Contour	GL	2.0	1995-1998		HB420x.724	D648	HB510x.580	D661
Contour	GL	2.5	1995-1998		HB420x.724	D648	HB510x.580	D661
Contour	LX	2.0	1995-1998		HB420x.724	D648	HB510x.580	D661
Contour	LX	2.5	1995-1998		HB420x.724	D648	HB510x.580	D661
Contour	SE	2.0	1998-1998		HB420x.724	D648	HB510x.580	D661
Contour	SE	2.5	1995-1998		HB420x.724	D648	HB510x.580	D661
Contour	Sport	2.0	1996-1996		HB420x.724	D648	HB510x.580	D661
Contour	Sport	2.5	1996-1997		HB420x.724	D648	HB510x.580	D661
Contour		2.0	1997-1998		HB420x.724	D648		
Contour		2.0	1999-2000		HB420x.724	D648	HB510x.580	D661
Contour		2.5	1999-2000		HB420x.724	D648	HB510x.580	D661
Country Squire	LX	5.0	1987-1991		HB125x.650	D199		
Country Squire		5.0	1987-1991		HB125x.650	D199		
Country Squire		5.8	1973-1974		HB292x.674	D50		
Country Squire		6.6	1973-1978		HB292x.674	D50		
Country Squire		7.0	1973-1973		HB292x.674	D50		
Country Squire		7.5	1973-1978		HB292x.674	D50		
Crown Victoria	LX	4.6	1992-1994		HB125x.650	D199		
Crown Victoria	LX	4.6	1995-1995		HB205x.672	D659		
Crown Victoria	LX	4.6	1996-1996	w/Steel Piston	HB205x.672	D659	HB341x.618	D674
Crown Victoria	LX	4.6	1996-1996	w/Phenolic Piston	HB205x.672	D659	HB353x.618	D690
Crown Victoria	LX	4.6	1997-1997		HB205x.672	D659	HB353x.618	D690
Crown Victoria	LX	4.6	1998-1998		HB294x.646	D748	HB353x.618	D690
Crown Victoria	LX	4.6	2006-2008		HB433x.654	D997		
Crown Victoria	LX Sport	4.6	2006-2006		HB433x.654	D997		
Crown Victoria	Police Interceptor	4.6	1993-1994		HB125x.650	D199		
Crown Victoria	Police Interceptor	4.6	1995-1995		HB205x.672	D659		
Crown Victoria	Police Interceptor	4.6	1996-1996	w/Steel Piston	HB205x.672	D659	HB341x.618	D674
Crown Victoria	Police Interceptor	4.6	1996-1996	w/Phenolic Piston	HB205x.672	D659	HB353x.618	D690
Crown Victoria	Police Interceptor	4.6	1997-1997		HB205x.672	D659	HB353x.618	D690
Crown Victoria	Police Interceptor	4.6	1998-1998		HB294x.646	D748	HB353x.618	D690
Crown Victoria	Police Interceptor	4.6	2006-2008		HB433x.654	D997		
Crown Victoria	S	4.6	1992-1994		HB125x.650	D199		
Crown Victoria	S	4.6	1995-1995		HB205x.672	D659		
Crown Victoria	S	4.6	1996-1996	w/Steel Piston	HB205x.672	D659	HB341x.618	D674
Crown Victoria	S	4.6	1996-1996	w/Phenolic Piston	HB205x.672	D659	HB353x.618	D690

CODE Breakdown

HB 245 x .631

Insert Compound Code

Make/Model	Submodel	Engine (Liter)	Years	Note	FRONT		REAR	
					Hawk #	FMSI	Hawk #	FMSI
FORD CONT.								
Crown Victoria	S	4.6	1997-1997		HB205x.672	D659	HB353x.618	D690
Crown Victoria	S	4.6	1998-1998		HB294x.646	D748	HB353x.618	D690
Crown Victoria	Touring Sedan	4.6	1992-1992		HB125x.650	D199		
Crown Victoria		4.6	1992-1994		HB125x.650	D199		
Crown Victoria		4.6	1995-1995		HB205x.672	D659		
Crown Victoria		4.6	1996-1996	w/Steel Piston	HB205x.672	D659	HB341x.618	D674
Crown Victoria		4.6	1996-1996	w/Phenolic Piston	HB205x.672	D659	HB353x.618	D690
Crown Victoria		4.6	1997-1997		HB205x.672	D659	HB353x.618	D690
Crown Victoria		4.6	1998-2002		HB294x.646	D748	HB353x.618	D690
Crown Victoria		4.6	2003-2004		HB433x.654	D997	HB443x.614	D932
Crown Victoria		4.6	2005-2008		HB433x.654	D997		
Custom 500		5.8	1975-1975		HB292x.674	D50		
Custom 500		6.6	1975-1975		HB292x.674	D50		
Custom 500		7.5	1975-1975		HB292x.674	D50		
E-100 Econoline	Club Wagon	4.9	1975-1977		HB292x.674	D50		
E-100 Econoline	Club Wagon	5.8	1975-1977		HB292x.674	D50		
E-100 Econoline		4.9	1975-1976		HB292x.674	D50		
E-100 Econoline		5.0	1975-1975		HB292x.674	D50		
E-100 Econoline		5.8	1975-1976		HB292x.674	D50		
E-150 Econoline	Club Wagon	4.2	1997-1998		HB295x.630	D632		
E-150 Econoline	Club Wagon	4.6	1997-1998		HB295x.630	D632		
E-150 Econoline	Club Wagon	4.9	1975-1986		HB292x.674	D50		
E-150 Econoline	Club Wagon	4.9	1987-1987		HB293x.668	D375		
E-150 Econoline	Club Wagon	4.9	1988-1989		HB293x.634	D375		
E-150 Econoline	Club Wagon	4.9	1990-1993		HB293x.668	D375		
E-150 Econoline	Club Wagon	4.9	1994-1996		HB295x.630	D632		
E-150 Econoline	Club Wagon	5.0	1979-1986		HB292x.674	D50		
E-150 Econoline	Club Wagon	5.0	1987-1987		HB293x.668	D375		
E-150 Econoline	Club Wagon	5.0	1988-1989		HB293x.634	D375		
E-150 Econoline	Club Wagon	5.0	1990-1993		HB293x.668	D375		
E-150 Econoline	Club Wagon	5.0	1994-1996		HB295x.630	D632		
E-150 Econoline	Club Wagon	5.4	1997-1998		HB295x.630	D632		
E-150 Econoline	Club Wagon	5.8	1975-1986		HB292x.674	D50		
E-150 Econoline	Club Wagon	5.8	1987-1987		HB293x.668	D375		
E-150 Econoline	Club Wagon	5.8	1988-1989		HB293x.634	D375		
E-150 Econoline	Club Wagon	5.8	1990-1993		HB293x.668	D375		
E-150 Econoline	Club Wagon	5.8	1994-1996		HB295x.630	D632		
E-150 Econoline	Club Wagon	7.5	1976-1977		HB292x.674	D50		
E-150 Econoline	Club Wagon	7.5	1979-1979		HB292x.674	D50		
E-150 Econoline	Super	4.9	1985-1986		HB292x.674	D50		
E-150 Econoline	Super	4.9	1987-1987		HB293x.668	D375		
E-150 Econoline	Super	4.9	1988-1989		HB293x.634	D375		
E-150 Econoline	Super	4.9	1990-1991		HB293x.668	D375		
E-150 Econoline	Super	5.0	1985-1986		HB292x.674	D50		
E-150 Econoline	Super	5.0	1987-1987		HB293x.668	D375		
E-150 Econoline	Super	5.0	1988-1989		HB293x.634	D375		
E-150 Econoline	Super	5.0	1990-1991		HB293x.668	D375		
E-150 Econoline	Super	5.8	1985-1986		HB292x.674	D50		
E-150 Econoline	Super	5.8	1987-1987		HB293x.668	D375		
E-150 Econoline	Super	5.8	1988-1989		HB293x.634	D375		
E-150 Econoline	Super	5.8	1990-1991		HB293x.668	D375		
E-150 Econoline		4.2	1997-2003		HB295x.630	D632		
E-150 Econoline		4.6	1997-2003		HB295x.630	D632		

RACE COMPOUND CODES

DTC-70 - U	DTC-05 - H	MT-4 - L	DR-97 - J
DTC-60 - G	HT-14 - V	Blue 9012 - E	HP Plus - N
DTC-30 - W	HT-10 - S	Black - M	

STREET COMPOUND CODES

HPS Performance Street - F	SuperDuty - P
Performance Ceramic - Z	
LTS Light Truck & SUV - Y	

Make/Model	Submodel	Engine		Note	FRONT		REAR	
		(Liter)	Years		Hawk #	FMSI	Hawk #	FMSI
FORD CONT.								
E-150 Econoline		4.9	1975-1976		HB292x.674	D50		
E-150 Econoline		4.9	1987-1987		HB293x.668	D375		
E-150 Econoline		4.9	1988-1989		HB293x.634	D375		
E-150 Econoline		4.9	1990-1993		HB293x.668	D375		
E-150 Econoline		4.9	1994-1996		HB295x.630	D632		
E-150 Econoline		5.0	1975-1975		HB292x.674	D50		
E-150 Econoline		5.0	1987-1987		HB293x.668	D375		
E-150 Econoline		5.0	1988-1989		HB293x.634	D375		
E-150 Econoline		5.0	1990-1993		HB293x.668	D375		
E-150 Econoline		5.0	1994-1996		HB295x.630	D632		
E-150 Econoline		5.4	1997-2003		HB295x.630	D632		
E-150 Econoline		5.8	1975-1976		HB292x.674	D50		
E-150 Econoline		5.8	1987-1987		HB293x.668	D375		
E-150 Econoline		5.8	1988-1989		HB293x.634	D375		
E-150 Econoline		5.8	1990-1993		HB293x.668	D375		
E-150 Econoline		5.8	1994-1996		HB295x.630	D632		
E-150 Econoline		7.5	1976-1976		HB292x.674	D50		
E-250		4.6	2006-2007		HB334x.736	D655	HB539x.650	D802
E-250		5.4	2006-2007		HB334x.736	D655	HB539x.650	D802
E-250 Econoline	Club Wagon	4.9	1977-1980		HB255x.655	D120		
E-250 Econoline	Club Wagon	4.9	1983-1988		HB255x.655	D120		
E-250 Econoline	Club Wagon	4.9	1989-1991		HB336x.655	D450		
E-250 Econoline	Club Wagon	5.0	1979-1980		HB255x.655	D120		
E-250 Econoline	Club Wagon	5.8	1976-1988		HB255x.655	D120		
E-250 Econoline	Club Wagon	5.8	1989-1991		HB336x.655	D450		
E-250 Econoline	Club Wagon	6.6	1980-1982		HB255x.655	D120		
E-250 Econoline	Club Wagon	6.9	1983-1987		HB255x.655	D120		
E-250 Econoline	Club Wagon	7.3	1988-1988		HB255x.655	D120		
E-250 Econoline	Club Wagon	7.3	1989-1991		HB336x.655	D450		
E-250 Econoline	Club Wagon	7.5	1976-1988		HB255x.655	D120		
E-250 Econoline	Club Wagon	7.5	1989-1991		HB336x.655	D450		
E-250 Econoline	HD	4.9	1991-1991		HB336x.655	D450		
E-250 Econoline	HD	5.8	1991-1991		HB336x.655	D450		
E-250 Econoline	Super	4.2	1997-1998		HB334x.736	D655		
E-250 Econoline	Super	4.9	1978-1988		HB255x.655	D120		
E-250 Econoline	Super	4.9	1989-1993		HB336x.655	D450		
E-250 Econoline	Super	4.9	1992-1994		HB333x.776	D557		
E-250 Econoline	Super	4.9	1995-1996		HB334x.736	D655		
E-250 Econoline	Super	5.0	1979-1979		HB255x.655	D120		
E-250 Econoline	Super	5.0	1981-1984		HB255x.655	D120		
E-250 Econoline	Super	5.0	1986-1988		HB255x.655	D120		
E-250 Econoline	Super	5.0	1989-1991		HB336x.655	D450		
E-250 Econoline	Super	5.4	1997-1998		HB334x.736	D655		
E-250 Econoline	Super	5.8	1977-1988		HB255x.655	D120		
E-250 Econoline	Super	5.8	1989-1993		HB336x.655	D450		
E-250 Econoline	Super	5.8	1992-1994		HB333x.776	D557		
E-250 Econoline	Super	5.8	1995-1996		HB334x.736	D655		
E-250 Econoline	Super	6.6	1980-1980		HB255x.655	D120		
E-250 Econoline	Super	7.3	1994-1994		HB333x.776	D557		
E-250 Econoline	Super	7.5	1978-1980		HB255x.655	D120		
E-250 Econoline	Super	7.5	1993-1993		HB333x.776	D557		
E-250 Econoline	Super	7.5	1993-1993		HB336x.655	D450		
E-250 Econoline	Super Wagon	4.9	1978-1980		HB255x.655	D120		

CODE Breakdown

HB 245 x .631

Insert Compound Code

Make/Model	Submodel	Engine (Liter)	Years	Note	FRONT		REAR	
					Hawk #	FMSI	Hawk #	FMSI
FORD CONT.								
E-250 Econoline	Super Wagon	4.9	1983-1984		HB255x.655	D120		
E-250 Econoline	Super Wagon	5.0	1979-1980		HB255x.655	D120		
E-250 Econoline	Super Wagon	5.8	1978-1981		HB255x.655	D120		
E-250 Econoline	Super Wagon	5.8	1983-1984		HB255x.655	D120		
E-250 Econoline	Super Wagon	6.6	1980-1980		HB255x.655	D120		
E-250 Econoline	Super Wagon	6.9	1983-1984		HB255x.655	D120		
E-250 Econoline	Super Wagon	7.5	1978-1979		HB255x.655	D120		
E-250 Econoline	Super Wagon	7.5	1981-1981		HB255x.655	D120		
E-250 Econoline	Super Wagon	7.5	1983-1984		HB255x.655	D120		
E-250 Econoline		4.2	1997-2003		HB334x.736	D655	HB539x.650	D802
E-250 Econoline		4.6	1997-1997		HB334x.736	D655		
E-250 Econoline		4.6	2003-2005		HB334x.736	D655	HB539x.650	D802
E-250 Econoline		4.9	1989-1991		HB336x.655	D450		
E-250 Econoline		4.9	1992-1994		HB333x.776	D557		
E-250 Econoline		4.9	1995-1996		HB334x.736	D655		
E-250 Econoline		5.0	1989-1991		HB336x.655	D450		
E-250 Econoline		5.4	1997-2000		HB334x.736	D655		
E-250 Econoline		5.4	2001-2005		HB334x.736	D655	HB539x.650	D802
E-250 Econoline		5.8	1989-1991		HB336x.655	D450		
E-250 Econoline		5.8	1992-1994		HB333x.776	D557		
E-250 Econoline		5.8	1995-1996		HB334x.736	D655		
E-250 Econoline		7.3	1994-1994		HB333x.776	D557		
E-250 Econoline		7.5	1993-1993		HB333x.776	D557		
E-350 Econoline	HD Club Wagon	4.9	1992-1994		HB333x.776	D557		
E-350 Econoline	HD Club Wagon	4.9	1995-1996		HB334x.736	D655		
E-350 Econoline	HD Club Wagon	5.4	1997-1998		HB334x.736	D655		
E-350 Econoline	HD Club Wagon	5.8	1992-1994		HB333x.776	D557		
E-350 Econoline	HD Club Wagon	5.8	1995-1996		HB334x.736	D655		
E-350 Econoline	HD Club Wagon	6.8	1997-1998		HB334x.736	D655		
E-350 Econoline	HD Club Wagon	7.3	1992-1994		HB333x.776	D557		
E-350 Econoline	HD Club Wagon	7.3	1995-1998		HB334x.736	D655		
E-350 Econoline	HD Club Wagon	7.5	1992-1994		HB333x.776	D557		
E-350 Econoline	HD Club Wagon	7.5	1995-1996		HB334x.736	D655		
E-350 Econoline	Super	4.9	1978-1988		HB255x.655	D120		
E-350 Econoline	Super	4.9	1989-1991		HB336x.655	D450		
E-350 Econoline	Super	4.9	1992-1994		HB333x.776	D557		
E-350 Econoline	Super	4.9	1995-1996		HB334x.736	D655		
E-350 Econoline	Super	5.0	1979-1980		HB255x.655	D120		
E-350 Econoline	Super	5.4	1997-1998		HB334x.736	D655		
E-350 Econoline	Super	5.4	1999-1999		HB334x.736	D655	HB539x.650	D802
E-350 Econoline	Super	5.8	1978-1988		HB255x.655	D120		
E-350 Econoline	Super	5.8	1989-1991		HB336x.655	D450		
E-350 Econoline	Super	5.8	1992-1994		HB333x.776	D557		
E-350 Econoline	Super	5.8	1995-1996		HB334x.736	D655		
E-350 Econoline	Super	6.6	1980-1982		HB255x.655	D120		
E-350 Econoline	Super	6.8	1997-1998		HB334x.736	D655		
E-350 Econoline	Super	6.9	1983-1987		HB255x.655	D120		
E-350 Econoline	Super	7.3	1988-1988		HB255x.655	D120		
E-350 Econoline	Super	7.3	1989-1991		HB336x.655	D450		
E-350 Econoline	Super	7.3	1992-1994		HB333x.776	D557		
E-350 Econoline	Super	7.3	1995-1998		HB334x.736	D655		
E-350 Econoline	Super	7.5	1978-1988		HB255x.655	D120		
E-350 Econoline	Super	7.5	1989-1991		HB336x.655	D450		

RACE COMPOUND CODES

DTC-70 - U | DTC-05 - H | MT-4 - L | DR-97 - J
 DTC-60 - G | HT-14 - V | Blue 9012 - E | HP Plus - N
 DTC-30 - W | HT-10 - S | Black - M

STREET COMPOUND CODES

HPS Performance Street - F | SuperDuty - P
 Performance Ceramic - Z
 LTS Light Truck & SUV - Y

Make/ Model	Submodel	Engine		Note	FRONT		REAR	
		(Liter)	Years		Hawk #	FMSI	Hawk #	FMSI
FORD CONT.								
E-350 Econoline	Super	7.5	1992-1994		HB333x.776	D557		
E-350 Econoline	Super	7.5	1995-1996		HB334x.736	D655		
E-350 Econoline	Super Wagon	4.9	1978-1988		HB255x.655	D120		
E-350 Econoline	Super Wagon	4.9	1989-1991		HB336x.655	D450		
E-350 Econoline	Super Wagon	4.9	1992-1994		HB333x.776	D557		
E-350 Econoline	Super Wagon	4.9	1995-1996		HB334x.736	D655		
E-350 Econoline	Super Wagon	5.0	1979-1980		HB255x.655	D120		
E-350 Econoline	Super Wagon	5.4	1997-1998		HB334x.736	D655		
E-350 Econoline	Super Wagon	5.4	1999-1999		HB334x.736	D655	HB539x.650	D802
E-350 Econoline	Super Wagon	5.8	1978-1988		HB255x.655	D120		
E-350 Econoline	Super Wagon	5.8	1989-1991		HB336x.655	D450		
E-350 Econoline	Super Wagon	5.8	1992-1994		HB333x.776	D557		
E-350 Econoline	Super Wagon	5.8	1995-1996		HB334x.736	D655		
E-350 Econoline	Super Wagon	6.6	1980-1982		HB255x.655	D120		
E-350 Econoline	Super Wagon	6.8	1997-1998		HB334x.736	D655		
E-350 Econoline	Super Wagon	6.9	1983-1987		HB255x.655	D120		
E-350 Econoline	Super Wagon	7.3	1988-1988		HB255x.655	D120		
E-350 Econoline	Super Wagon	7.3	1989-1991		HB336x.655	D450		
E-350 Econoline	Super Wagon	7.3	1992-1994		HB333x.776	D557		
E-350 Econoline	Super Wagon	7.3	1995-1998		HB334x.736	D655		
E-350 Econoline	Super Wagon	7.5	1978-1988		HB255x.655	D120		
E-350 Econoline	Super Wagon	7.5	1989-1991		HB336x.655	D450		
E-350 Econoline	Super Wagon	7.5	1992-1994		HB333x.776	D557		
E-350 Econoline	Super Wagon	7.5	1995-1996		HB334x.736	D655		
E-350 Econoline		4.9	1989-1991		HB336x.655	D450		
E-350 Econoline		4.9	1992-1994		HB333x.776	D557		
E-350 Econoline		4.9	1995-1996		HB334x.736	D655		
E-350 Econoline		5.4	1997-1998		HB334x.736	D655		
E-350 Econoline		5.4	1999-2005		HB334x.736	D655	HB539x.650	D802
E-350 Econoline		5.8	1989-1991		HB336x.655	D450		
E-350 Econoline		5.8	1992-1994		HB333x.776	D557		
E-350 Econoline		5.8	1995-1996		HB334x.736	D655		
E-350 Econoline		6.0	2004-2005		HB334x.736	D655	HB539x.650	D802
E-350 Econoline		6.8	1997-1998		HB334x.736	D655		
E-350 Econoline		6.8	1999-2005		HB334x.736	D655	HB539x.650	D802
E-350 Econoline		7.3	1989-1991		HB336x.655	D450		
E-350 Econoline		7.3	1992-1994		HB333x.776	D557		
E-350 Econoline		7.3	1995-1998		HB334x.736	D655		
E-350 Econoline		7.3	1999-2003		HB334x.736	D655	HB539x.650	D802
E-350 Econoline		7.5	1989-1991		HB336x.655	D450		
E-350 Econoline		7.5	1992-1994		HB333x.776	D557		
E-350 Econoline		7.5	1995-1996		HB334x.736	D655		
E-350 Super Duty	XL	5.4	2006-2007		HB334x.736	D655	HB539x.650	D802
E-350 Super Duty	XL	6.0	2006-2007		HB334x.736	D655	HB539x.650	D802
E-350 Super Duty	XL	6.8	2006-2007		HB334x.736	D655	HB539x.650	D802
E-350 Super Duty	XLT	5.4	2006-2007		HB334x.736	D655	HB539x.650	D802
E-350 Super Duty	XLT	6.0	2006-2007		HB334x.736	D655	HB539x.650	D802
E-350 Super Duty	XLT	6.8	2006-2007		HB334x.736	D655	HB539x.650	D802
E-350 Super Duty		5.4	2006-2007		HB334x.736	D655	HB539x.650	D802
E-350 Super Duty		6.0	2006-2007		HB334x.736	D655	HB539x.650	D802
E-350 Super Duty		6.8	2006-2007		HB334x.736	D655	HB539x.650	D802
E-450 Econoline		5.4	2003-2003		HB334x.736	D655	HB334x.736	D655
E-450 Econoline		6.8	2003-2003		HB334x.736	D655	HB334x.736	D655

CODE Breakdown

HB 245 x .631

Insert Compound Code

Make/Model	Submodel	Engine (Liter)	Years	Note	FRONT		REAR	
					Hawk #	FMSI	Hawk #	FMSI
FORD CONT.								
E-450 Econoline		7.3	2003-2003		HB334x.736	D655	HB334x.736	D655
Elite		5.8	1975-1975		HB292x.674	D50		
Elite		6.6	1975-1975		HB292x.674	D50		
Elite		7.5	1975-1975		HB292x.674	D50		
Escape	Hybrid	2.3	2007-2007		HB473x.752	D843		
Escape	Limited	3.0	2006-2007		HB473x.752	D843		
Escape	XLS	2.3	2006-2007		HB473x.752	D843		
Escape	XLT	2.3	2006-2007		HB473x.752	D843		
Escape	XLT	3.0	2006-2007		HB473x.752	D843		
Escape		2.0	2001-2004		HB473x.752	D843		
Escape		2.3	2005-2005		HB473x.752	D843		
Escape		3.0	2001-2005		HB473x.752	D843		
Escort	GT	1.8	1991-1996		HB246x.567	D473	HB157x.484	D458
Escort	LX	1.9	1991-1996		HB246x.567	D473		
Escort	LX	2.0	1997-1998		HB246x.567	D473	HB159x.492	D636
Escort	LX-E	1.8	1992-1993		HB246x.567	D473		
Escort	Pony	1.9	1991-1992		HB246x.567	D473		
Escort	Sport	1.9	1993-1995		HB246x.567	D473		
Escort	Sport	2.0	1997-1998		HB246x.567	D473	HB159x.492	D636
Escort		1.9	1993-1996		HB246x.567	D473		
Escort		2.0	1997-2002		HB246x.567	D473	HB159x.492	D636
Excursion		5.4	2000-2005		HB302x.700	D824	HB303x.685	D757
Excursion		6.0	2003-2005		HB302x.700	D824	HB303x.685	D757
Excursion		6.8	2000-2005		HB302x.700	D824	HB303x.685	D757
Excursion		7.3	2000-2003		HB302x.700	D824	HB303x.685	D757
Expedition	Eddie Bauer	5.4	2006-2006		HB462x.827	D934	HB463x.787	D935
Expedition	Eddie Bauer	5.4	2007-2008		HB578x.735	D1278	HB579x.785	D1279
Expedition	EL Eddie Bauer	5.4	2007-2008		HB578x.735	D1278	HB579x.785	D1279
Expedition	EL King Ranch	5.4	2008-2008		HB578x.735	D1278	HB579x.785	D1279
Expedition	EL Limited	5.4	2007-2008		HB578x.735	D1278	HB579x.785	D1279
Expedition	EL XLT	5.4	2007-2008		HB578x.735	D1278	HB579x.785	D1279
Expedition	Funkmaster Flex	5.4	2008-2008		HB578x.735	D1278	HB579x.785	D1279
Expedition	King Ranch	5.4	2006-2006		HB462x.827	D934	HB463x.787	D935
Expedition	King Ranch	5.4	2008-2008		HB578x.735	D1278	HB579x.785	D1279
Expedition	Limited	5.4	2006-2006		HB462x.827	D934	HB463x.787	D935
Expedition	Limited	5.4	2007-2008		HB578x.735	D1278	HB579x.785	D1279
Expedition	XLS	5.4	2006-2006		HB462x.827	D934	HB463x.787	D935
Expedition	XLT	5.4	2006-2006		HB462x.827	D934	HB463x.787	D935
Expedition	XLT	5.4	2007-2008		HB578x.735	D1278	HB579x.785	D1279
Expedition	XLT Sport	5.4	2006-2006		HB462x.827	D934	HB463x.787	D935
Expedition		4.6	1997-2002		HB299x.650	D702	HB301x.630	D711
Expedition		4.6	2003-2004		HB462x.827	D934	HB463x.787	D935
Expedition		5.4	1997-2002		HB299x.650	D702	HB301x.630	D711
Expedition		5.4	2003-2005		HB462x.827	D934	HB463x.787	D935
Explorer	Sport	4.0	2001-2001		HB472x.650	D833		
Explorer	Sport	4.0	2002-2003		HB472x.650	D833	HB287x.571	D667
Explorer		4.0	1991-1994		HB279x.594	D249		
Explorer		4.0	1995-2001		HB283x.650	D652	HB287x.571	D667
Explorer		4.0	2002-2004		HB472x.650	D833	HB520x.575	D881
Explorer		4.0	2005-2005		HB472x.650	D833		
Explorer		4.6	2002-2004		HB472x.650	D833	HB520x.575	D881
Explorer		4.6	2005-2005		HB472x.650	D833		
Explorer		5.0	1996-2001		HB283x.650	D652	HB287x.571	D667

RACE COMPOUND CODES

DTC-70 - U | DTC-05 - H | MT-4 - L | DR-97 - J
 DTC-60 - G | HT-14 - V | Blue 9012 - E | HP Plus - N
 DTC-30 - W | HT-10 - S | Black - M

STREET COMPOUND CODES

HPS Performance Street - F | SuperDuty - P
 Performance Ceramic - Z
 LTS Light Truck & SUV - Y

Make/Model	Submodel	Engine		Note	FRONT		REAR	
		(Liter)	Years		Hawk #	FMSI	Hawk #	FMSI
FORD CONT.								
Explorer Sport Trac		4.0	2001-2002		HB472x.650	D833		
Explorer Sport Trac		4.0	2003-2005		HB472x.650	D833	HB287x.571	D667
F-100 Pickup	Super Cab	4.9	1977-1977		HB292x.674	D50		
F-100 Pickup	Super Cab	5.8	1977-1977		HB292x.674	D50		
F-100 Pickup	Super Cab	6.6	1977-1977		HB292x.674	D50		
F-100 Pickup		3.9	1973-1975		HB292x.674	D50		
F-100 Pickup		4.9	1973-1977		HB292x.674	D50		
F-100 Pickup		5.0	1973-1977		HB292x.674	D50		
F-100 Pickup		5.8	1977-1977		HB292x.674	D50		
F-100 Pickup		5.9	1973-1976		HB292x.674	D50		
F-100 Pickup		6.4	1973-1976		HB292x.674	D50		
F-100 Pickup		6.6	1977-1977		HB292x.674	D50		
F-100 Pickup		7.5	1973-1977		HB292x.674	D50		
F-150 Pickup	FX2	4.6	2008-2008		HB455x.785	D1083	HB456x.705	D1012
F-150 Pickup	FX2	5.4	2007-2008		HB455x.785	D1083	HB456x.705	D1012
F-150 Pickup	FX4	5.4	2005-2008		HB455x.785	D1083	HB456x.705	D1012
F-150 Pickup	Harley-Davidson Edition	5.4	2001-2003	Except 7700 lb GVW	HB266x.650	D679	HB301x.630	D711
F-150 Pickup	Harley-Davidson Edition	5.4	2001-2003	7700 lb GVW	HB299x.650	D702	HB301x.630	D711
F-150 Pickup	Harley-Davidson Edition	5.4	2006-2008		HB455x.785	D1083	HB456x.705	D1012
F-150 Pickup	Heritage	4.2	2004-2004	Except 7700 lb GVW	HB266x.650	D679	HB301x.630	D711
F-150 Pickup	Heritage	4.2	2004-2004	7700 lb GVW	HB299x.650	D702	HB301x.630	D711
F-150 Pickup	Heritage	4.6	2004-2004	Except 7700 lb GVW	HB266x.650	D679	HB301x.630	D711
F-150 Pickup	Heritage	4.6	2004-2004	7700 lb GVW	HB299x.650	D702	HB301x.630	D711
F-150 Pickup	Heritage	5.4	2004-2004	Except 7700 lb GVW	HB266x.650	D679	HB301x.630	D711
F-150 Pickup	Heritage	5.4	2004-2004	7700 lb GVW	HB299x.650	D702	HB301x.630	D711
F-150 Pickup	King Ranch	5.4	2005-2008		HB455x.785	D1083	HB456x.705	D1012
F-150 Pickup	Lariat	5.4	2005-2008		HB455x.785	D1083	HB456x.705	D1012
F-150 Pickup	Lightning	5.4	1999-2003	Except 7700 lb GVW	HB266x.650	D679	HB301x.630	D711
F-150 Pickup	Lightning	5.4	1999-2003	7700 lb GVW	HB299x.650	D702	HB301x.630	D711
F-150 Pickup	Lightning	5.8	1993-1993		HB293x.668	D375		
F-150 Pickup	Lightning	5.8	1994-1995		HB295x.630	D632		
F-150 Pickup	Limited	5.4	2008-2008		HB455x.785	D1083	HB456x.705	D1012
F-150 Pickup	STX	4.2	2005-2008		HB455x.785	D1083	HB456x.705	D1012
F-150 Pickup	STX	4.6	2005-2008		HB455x.785	D1083	HB456x.705	D1012
F-150 Pickup	Super Cab	4.2	1997-1997		HB266x.650	D679		
F-150 Pickup	Super Cab	4.6	1997-1997		HB266x.650	D679		
F-150 Pickup	Super Cab	4.6	1998-1998		HB266x.650	D679	HB301x.630	D711
F-150 Pickup	Super Cab	4.9	1977-1985		HB292x.674	D50		
F-150 Pickup	Super Cab	4.9	1986-1987		HB293x.668	D375		
F-150 Pickup	Super Cab	4.9	1988-1989		HB293x.634	D375		
F-150 Pickup	Super Cab	4.9	1990-1993		HB293x.668	D375		
F-150 Pickup	Super Cab	4.9	1995-1996		HB295x.630	D632		
F-150 Pickup	Super Cab	5.0	1977-1985		HB292x.674	D50		
F-150 Pickup	Super Cab	5.0	1986-1987		HB293x.668	D375		
F-150 Pickup	Super Cab	5.0	1988-1989		HB293x.634	D375		
F-150 Pickup	Super Cab	5.0	1990-1993		HB293x.668	D375		
F-150 Pickup	Super Cab	5.0	1995-1996		HB295x.630	D632		
F-150 Pickup	Super Cab	5.4	1997-1997		HB266x.650	D679		
F-150 Pickup	Super Cab	5.4	1998-1998		HB266x.650	D679	HB301x.630	D711
F-150 Pickup	Super Cab	5.8	1977-1985		HB292x.674	D50		
F-150 Pickup	Super Cab	5.8	1986-1987		HB293x.668	D375		
F-150 Pickup	Super Cab	5.8	1988-1989		HB293x.634	D375		
F-150 Pickup	Super Cab	5.8	1990-1993		HB293x.668	D375		

CODE Breakdown

HB 245 x .631

Insert Compound Code

Make/Model	Submodel	Engine (Liter)	Years	Note	FRONT		REAR	
					Hawk #	FMSI	Hawk #	FMSI
FORD CONT.								
F-150 Pickup	Super Cab	5.8	1995-1996		HB295x.630	D632		
F-150 Pickup	Super Cab	6.6	1977-1979		HB292x.674	D50		
F-150 Pickup	Super Cab	7.5	1977-1979		HB292x.674	D50		
F-150 Pickup	XL	4.2	2005-2008		HB455x.785	D1083	HB456x.705	D1012
F-150 Pickup	XL	4.6	2005-2008		HB455x.785	D1083	HB456x.705	D1012
F-150 Pickup	XL	5.4	2005-2008		HB455x.785	D1083	HB456x.705	D1012
F-150 Pickup	XLT	4.2	2005-2008		HB455x.785	D1083	HB456x.705	D1012
F-150 Pickup	XLT	4.6	2005-2008		HB455x.785	D1083	HB456x.705	D1012
F-150 Pickup	XLT	5.4	2005-2008		HB455x.785	D1083	HB456x.705	D1012
F-150 Pickup		3.9	1975-1976		HB292x.674	D50		
F-150 Pickup		4.2	1997-1997		HB266x.650	D679		
F-150 Pickup		4.2	1998-1998		HB266x.650	D679	HB301x.630	D711
F-150 Pickup		4.2	1999-2003	Except 7700 lbs. GVW	HB266x.650	D679	HB301x.630	D711
F-150 Pickup		4.2	1999-2003	7700 lbs. GVW	HB299x.650	D702	HB301x.630	D711
F-150 Pickup		4.6	1997-1997		HB266x.650	D679		
F-150 Pickup		4.6	1998-1998		HB266x.650	D679	HB301x.630	D711
F-150 Pickup		4.6	1999-2003	Except 7700 lbs. GVW	HB266x.650	D679	HB301x.630	D711
F-150 Pickup		4.6	1999-2003	7700 lbs. GVW	HB299x.650	D702	HB301x.630	D711
F-150 Pickup		4.6	2004-2004		HB455x.785	D1083	HB456x.705	D1012
F-150 Pickup		4.9	1975-1985		HB292x.674	D50		
F-150 Pickup		4.9	1986-1987		HB293x.668	D375		
F-150 Pickup		4.9	1988-1989		HB293x.634	D375		
F-150 Pickup		4.9	1990-1993		HB293x.668	D375		
F-150 Pickup		4.9	1994-1996		HB295x.630	D632		
F-150 Pickup		5.0	1975-1985		HB292x.674	D50		
F-150 Pickup		5.0	1986-1987		HB293x.668	D375		
F-150 Pickup		5.0	1988-1989		HB293x.634	D375		
F-150 Pickup		5.0	1990-1993		HB293x.668	D375		
F-150 Pickup		5.0	1994-1996		HB295x.630	D632		
F-150 Pickup		5.4	1997-1997		HB266x.650	D679		
F-150 Pickup		5.4	1998-1998		HB266x.650	D679	HB301x.630	D711
F-150 Pickup		5.4	1999-2003	Except 7700 lbs. GVW	HB266x.650	D679	HB301x.630	D711
F-150 Pickup		5.4	1999-2003	7700 lbs. GVW	HB299x.650	D702	HB301x.630	D711
F-150 Pickup		5.4	2004-2004		HB455x.785	D1083	HB456x.705	D1012
F-150 Pickup		5.8	1977-1985		HB292x.674	D50		
F-150 Pickup		5.8	1986-1987		HB293x.668	D375		
F-150 Pickup		5.8	1988-1989		HB293x.634	D375		
F-150 Pickup		5.8	1990-1993		HB293x.668	D375		
F-150 Pickup		5.8	1994-1996		HB295x.630	D632		
F-150 Pickup		5.9	1975-1976		HB292x.674	D50		
F-150 Pickup		6.4	1975-1976		HB292x.674	D50		
F-150 Pickup		6.6	1977-1979		HB292x.674	D50		
F-150 Pickup		6.9	1984-1984		HB292x.674	D50		
F-150 Pickup		7.5	1975-1979		HB292x.674	D50		
F-250 Pickup	Super Cab	4.6	1997-1998		HB299x.650	D702	HB301x.630	D711
F-250 Pickup	Super Cab	4.6	1999-1999		HB299x.650	D702		
F-250 Pickup	Super Cab	4.9	1977-1983	w/Single Piston	HB292x.674	D50		
F-250 Pickup	Super Cab	4.9	1977-1986	w/Dual Piston	HB255x.655	D120		
F-250 Pickup	Super Cab	4.9	1987-1988		HB255x.655	D120		
F-250 Pickup	Super Cab	4.9	1990-1994		HB336x.655	D450		
F-250 Pickup	Super Cab	4.9	1995-1995		HB334x.736	D655		
F-250 Pickup	Super Cab	5.0	1977-1983	w/Dual Piston	HB255x.655	D120		
F-250 Pickup	Super Cab	5.0	1977-1983	w/Single Piston	HB292x.674	D50		

RACE COMPOUND CODES

DTC-70 - U	DTC-05 - H	MT-4 - L	DR-97 - J
DTC-60 - G	HT-14 - V	Blue 9012 - E	HP Plus - N
DTC-30 - W	HT-10 - S	Black - M	

STREET COMPOUND CODES

HPS Performance Street - F	SuperDuty - P
Performance Ceramic - Z	
LTS Light Truck & SUV - Y	

Make/Model	Submodel	Engine (Liter)	Years	Note	FRONT		REAR	
					Hawk #	FMSI	Hawk #	FMSI
FORD CONT.								
F-250 Pickup	Super Cab	5.4	1997-1998		HB299x.650	D702	HB301x.630	D711
F-250 Pickup	Super Cab	5.4	1999-1999		HB299x.650	D702		
F-250 Pickup	Super Cab	5.8	1977-1983	w/Single Piston	HB292x.674	D50		
F-250 Pickup	Super Cab	5.8	1977-1986	w/Dual Piston	HB255x.655	D120		
F-250 Pickup	Super Cab	5.8	1987-1988		HB255x.655	D120		
F-250 Pickup	Super Cab	5.8	1989-1994		HB336x.655	D450		
F-250 Pickup	Super Cab	5.8	1995-1996		HB334x.736	D655		
F-250 Pickup	Super Cab	5.8	1997-1997		HB299x.650	D702	HB301x.630	D711
F-250 Pickup	Super Cab	6.6	1977-1982	w/Dual Piston	HB255x.655	D120		
F-250 Pickup	Super Cab	6.6	1977-1982	w/Single Piston	HB292x.674	D50		
F-250 Pickup	Super Cab	6.9	1983-1983	w/Single Piston	HB292x.674	D50		
F-250 Pickup	Super Cab	6.9	1983-1986	w/Dual Piston	HB255x.655	D120		
F-250 Pickup	Super Cab	6.9	1987-1987		HB255x.655	D120		
F-250 Pickup	Super Cab	7.3	1988-1988		HB255x.655	D120		
F-250 Pickup	Super Cab	7.3	1989-1994		HB336x.655	D450		
F-250 Pickup	Super Cab	7.3	1995-1996		HB334x.736	D655		
F-250 Pickup	Super Cab	7.3	1997-1997		HB299x.650	D702	HB301x.630	D711
F-250 Pickup	Super Cab	7.5	1977-1979	w/Dual Piston	HB255x.655	D120		
F-250 Pickup	Super Cab	7.5	1977-1979	w/Single Piston	HB292x.674	D50		
F-250 Pickup	Super Cab	7.5	1983-1983	w/Single Piston	HB292x.674	D50		
F-250 Pickup	Super Cab	7.5	1983-1986	w/Dual Piston	HB255x.655	D120		
F-250 Pickup	Super Cab	7.5	1987-1988		HB255x.655	D120		
F-250 Pickup	Super Cab	7.5	1989-1994		HB336x.655	D450		
F-250 Pickup	Super Cab	7.5	1995-1996		HB334x.736	D655		
F-250 Pickup	Super Cab	7.5	1997-1997		HB299x.650	D702	HB301x.630	D711
F-250 Pickup		3.9	1973-1974		HB292x.674	D50		
F-250 Pickup		4.6	1997-1998		HB299x.650	D702	HB301x.630	D711
F-250 Pickup		4.6	1999-1999		HB299x.650	D702		
F-250 Pickup		4.9	1973-1976		HB292x.674	D50		
F-250 Pickup		4.9	1976-1976		HB255x.655	D120		
F-250 Pickup		4.9	1977-1983	w/Single Piston	HB292x.674	D50		
F-250 Pickup		4.9	1977-1986	w/Dual Piston	HB255x.655	D120		
F-250 Pickup		4.9	1987-1988		HB255x.655	D120		
F-250 Pickup		4.9	1989-1994		HB336x.655	D450		
F-250 Pickup		4.9	1995-1996		HB334x.736	D655		
F-250 Pickup		5.0	1973-1976		HB292x.674	D50		
F-250 Pickup		5.0	1976-1976		HB255x.655	D120		
F-250 Pickup		5.0	1977-1983	w/Single Piston	HB292x.674	D50		
F-250 Pickup		5.0	1977-1986	w/Dual Piston	HB255x.655	D120		
F-250 Pickup		5.0	1987-1988		HB255x.655	D120		
F-250 Pickup		5.0	1989-1994		HB336x.655	D450		
F-250 Pickup		5.0	1995-1996		HB334x.736	D655		
F-250 Pickup		5.4	1997-1998		HB299x.650	D702	HB301x.630	D711
F-250 Pickup		5.4	1999-1999		HB299x.650	D702		
F-250 Pickup		5.8	1977-1983	w/Single Piston	HB292x.674	D50		
F-250 Pickup		5.8	1977-1986	w/Dual Piston	HB255x.655	D120		
F-250 Pickup		5.8	1987-1988		HB255x.655	D120		
F-250 Pickup		5.8	1989-1994		HB336x.655	D450		
F-250 Pickup		5.8	1995-1996		HB334x.736	D655		
F-250 Pickup		5.8	1997-1997		HB299x.650	D702	HB301x.630	D711
F-250 Pickup		5.9	1973-1976		HB292x.674	D50		
F-250 Pickup		5.9	1976-1976		HB255x.655	D120		
F-250 Pickup		6.4	1973-1976		HB292x.674	D50		

CODE Breakdown

HB 245 x .631

Insert Compound Code

Make/Model	Submodel	Engine (Liter)	Years	Note	FRONT		REAR	
					Hawk #	FMSI	Hawk #	FMSI
FORD CONT.								
F-250 Pickup		6.4	1976-1976		HB255x.655	D120		
F-250 Pickup		6.6	1977-1982	w/Dual Piston	HB255x.655	D120		
F-250 Pickup		6.6	1977-1982	w/Single Piston	HB292x.674	D50		
F-250 Pickup		6.9	1983-1983	w/Single Piston	HB292x.674	D50		
F-250 Pickup		6.9	1983-1986	w/Dual Piston	HB255x.655	D120		
F-250 Pickup		6.9	1987-1987		HB255x.655	D120		
F-250 Pickup		7.3	1988-1988		HB255x.655	D120		
F-250 Pickup		7.3	1989-1994		HB336x.655	D450		
F-250 Pickup		7.3	1995-1996		HB334x.736	D655		
F-250 Pickup		7.3	1997-1997		HB299x.650	D702	HB301x.630	D711
F-250 Pickup		7.5	1973-1976		HB292x.674	D50		
F-250 Pickup		7.5	1976-1976		HB255x.655	D120		
F-250 Pickup		7.5	1977-1979	w/Dual Piston	HB255x.655	D120		
F-250 Pickup		7.5	1977-1979	w/Single Piston	HB292x.674	D50		
F-250 Pickup		7.5	1983-1983	w/Single Piston	HB292x.674	D50		
F-250 Pickup		7.5	1983-1986	w/Dual Piston	HB255x.655	D120		
F-250 Pickup		7.5	1987-1988		HB255x.655	D120		
F-250 Pickup		7.5	1989-1994		HB336x.655	D450		
F-250 Pickup		7.5	1995-1996		HB334x.736	D655		
F-250 Pickup		7.5	1997-1997		HB299x.650	D702	HB301x.630	D711
F-250 Super Duty P/U	FX4	5.4	2008-2008		HB528x.811	D1069	HB556x.710	D1067
F-250 Super Duty P/U	FX4	6.4	2008-2008		HB528x.811	D1069	HB556x.710	D1067
F-250 Super Duty P/U	FX4	6.8	2008-2008		HB528x.811	D1069	HB556x.710	D1067
F-250 Super Duty P/U	Harley-Davidson Edition	6.0	2006-2007		HB528x.811	D1069	HB529x.710	D1068
F-250 Super Duty P/U	Harley-Davidson Edition	6.4	2008-2008		HB528x.811	D1069	HB556x.710	D1067
F-250 Super Duty P/U	Harley-Davidson Edition	6.8	2008-2008		HB528x.811	D1069	HB556x.710	D1067
F-250 Super Duty P/U	King Ranch	5.4	2006-2007		HB528x.811	D1069	HB529x.710	D1068
F-250 Super Duty P/U	King Ranch	5.4	2008-2008		HB528x.811	D1069	HB556x.710	D1067
F-250 Super Duty P/U	King Ranch	6.0	2006-2007		HB528x.811	D1069	HB529x.710	D1068
F-250 Super Duty P/U	King Ranch	6.4	2008-2008		HB528x.811	D1069	HB556x.710	D1067
F-250 Super Duty P/U	King Ranch	6.8	2006-2007		HB528x.811	D1069	HB529x.710	D1068
F-250 Super Duty P/U	King Ranch	6.8	2008-2008		HB528x.811	D1069	HB556x.710	D1067
F-250 Super Duty P/U	Lariat	5.4	2006-2007		HB528x.811	D1069	HB529x.710	D1068
F-250 Super Duty P/U	Lariat	5.4	2008-2008		HB528x.811	D1069	HB556x.710	D1067
F-250 Super Duty P/U	Lariat	6.0	2006-2007		HB528x.811	D1069	HB529x.710	D1068
F-250 Super Duty P/U	Lariat	6.4	2008-2008		HB528x.811	D1069	HB556x.710	D1067
F-250 Super Duty P/U	Lariat	6.8	2006-2007		HB528x.811	D1069	HB529x.710	D1068
F-250 Super Duty P/U	Lariat	6.8	2008-2008		HB528x.811	D1069	HB556x.710	D1067
F-250 Super Duty P/U	XL	5.4	2006-2007		HB528x.811	D1069	HB529x.710	D1068
F-250 Super Duty P/U	XL	5.4	2008-2008		HB528x.811	D1069	HB556x.710	D1067
F-250 Super Duty P/U	XL	6.0	2006-2007		HB528x.811	D1069	HB529x.710	D1068
F-250 Super Duty P/U	XL	6.4	2008-2008		HB528x.811	D1069	HB556x.710	D1067
F-250 Super Duty P/U	XL	6.8	2006-2007		HB528x.811	D1069	HB529x.710	D1068
F-250 Super Duty P/U	XL	6.8	2008-2008		HB528x.811	D1069	HB556x.710	D1067
F-250 Super Duty P/U	XLT	5.4	2006-2007		HB528x.811	D1069	HB529x.710	D1068
F-250 Super Duty P/U	XLT	5.4	2008-2008		HB528x.811	D1069	HB556x.710	D1067
F-250 Super Duty P/U	XLT	6.0	2006-2007		HB528x.811	D1069	HB529x.710	D1068
F-250 Super Duty P/U	XLT	6.4	2008-2008		HB528x.811	D1069	HB556x.710	D1067
F-250 Super Duty P/U	XLT	6.8	2006-2007		HB528x.811	D1069	HB529x.710	D1068
F-250 Super Duty P/U	XLT	6.8	2008-2008		HB528x.811	D1069	HB556x.710	D1067
F-250 Super Duty P/U		5.4	1999-2004		HB302x.700	D824	HB303x.685	D757
F-250 Super Duty P/U		5.4	2005-2005		HB528x.811	D1069	HB529x.710	D1068
F-250 Super Duty P/U		6.0	2003-2004		HB302x.700	D824	HB303x.685	D757

RACE COMPOUND CODES

DTC-70 - U	DTC-05 - H	MT-4 - L	DR-97 - J
DTC-60 - G	HT-14 - V	Blue 9012 - E	HP Plus - N
DTC-30 - W	HT-10 - S	Black - M	

STREET COMPOUND CODES

HPS Performance Street - F	SuperDuty - P
Performance Ceramic - Z	
LTS Light Truck & SUV - Y	

Make/Model	Submodel	Engine (Liter)	Years	Note	FRONT		REAR	
					Hawk #	FMSI	Hawk #	FMSI
FORD CONT.								
F-250 Super Duty P/U		6.0	2005-2005		HB528x.811	D1069	HB529x.710	D1068
F-250 Super Duty P/U		6.8	1999-2004		HB302x.700	D824	HB303x.685	D757
F-250 Super Duty P/U		6.8	2005-2005		HB528x.811	D1069	HB529x.710	D1068
F-250 Super Duty P/U		7.3	1999-2003		HB302x.700	D824	HB303x.685	D757
F-350 Pickup	Super Cab	4.9	1979-1980		HB255x.655	D120		
F-350 Pickup	Super Cab	5.0	1979-1980		HB255x.655	D120		
F-350 Pickup	Super Cab	5.8	1977-1980		HB255x.655	D120		
F-350 Pickup	Super Cab	5.8	1995-1997		HB334x.736	D655		
F-350 Pickup	Super Cab	6.6	1977-1980		HB255x.655	D120		
F-350 Pickup	Super Cab	7.3	1988-1988		HB255x.655	D120		
F-350 Pickup	Super Cab	7.3	1989-1994		HB336x.655	D450		
F-350 Pickup	Super Cab	7.3	1995-1997		HB334x.736	D655		
F-350 Pickup	Super Cab	7.5	1977-1979		HB255x.655	D120		
F-350 Pickup	Super Cab	7.5	1988-1988		HB255x.655	D120		
F-350 Pickup	Super Cab	7.5	1989-1994		HB336x.655	D450		
F-350 Pickup	Super Cab	7.5	1995-1997		HB334x.736	D655		
F-350 Pickup		4.9	1976-1988		HB255x.655	D120		
F-350 Pickup		4.9	1989-1994		HB336x.655	D450		
F-350 Pickup		4.9	1995-1996		HB334x.736	D655		
F-350 Pickup		5.0	1976-1980		HB255x.655	D120		
F-350 Pickup		5.8	1977-1988		HB255x.655	D120		
F-350 Pickup		5.8	1989-1994		HB336x.655	D450		
F-350 Pickup		5.8	1995-1997		HB334x.736	D655		
F-350 Pickup		5.9	1976-1976		HB255x.655	D120		
F-350 Pickup		6.4	1976-1976		HB255x.655	D120		
F-350 Pickup		6.6	1977-1982		HB255x.655	D120		
F-350 Pickup		6.9	1983-1987		HB255x.655	D120		
F-350 Pickup		7.3	1988-1988		HB255x.655	D120		
F-350 Pickup		7.3	1989-1994		HB336x.655	D450		
F-350 Pickup		7.3	1995-1997		HB334x.736	D655		
F-350 Pickup		7.5	1976-1979		HB255x.655	D120		
F-350 Pickup		7.5	1983-1988		HB255x.655	D120		
F-350 Pickup		7.5	1989-1994		HB336x.655	D450		
F-350 Pickup		7.5	1995-1997		HB334x.736	D655		
F-350 Super Duty P/U	FX4	5.4	2008-2008		HB528x.811	D1069	HB556x.710	D1067
F-350 Super Duty P/U	FX4	6.4	2008-2008		HB528x.811	D1069	HB556x.710	D1067
F-350 Super Duty P/U	FX4	6.8	2008-2008		HB528x.811	D1069	HB556x.710	D1067
F-350 Super Duty P/U	Harley-Davidson Edition	6.0	2006-2007	Single Rear Wheels	HB528x.811	D1069	HB529x.710	D1068
F-350 Super Duty P/U	Harley-Davidson Edition	6.0	2006-2007	Dual Rear Wheels	HB528x.811	D1069	HB556x.710	D1067
F-350 Super Duty P/U	Harley-Davidson Edition	6.4	2008-2008		HB528x.811	D1069	HB556x.710	D1067
F-350 Super Duty P/U	Harley-Davidson Edition	6.8	2008-2008		HB528x.811	D1069	HB556x.710	D1067
F-350 Super Duty P/U	King Ranch	5.4	2006-2007	Single Rear Wheels	HB528x.811	D1069	HB529x.710	D1068
F-350 Super Duty P/U	King Ranch	5.4	2006-2007	Dual Rear Wheels	HB528x.811	D1069	HB556x.710	D1067
F-350 Super Duty P/U	King Ranch	5.4	2008-2008		HB528x.811	D1069	HB556x.710	D1067
F-350 Super Duty P/U	King Ranch	6.0	2006-2007	Single Rear Wheels	HB528x.811	D1069	HB529x.710	D1068
F-350 Super Duty P/U	King Ranch	6.0	2006-2007	Dual Rear Wheels	HB528x.811	D1069	HB556x.710	D1067
F-350 Super Duty P/U	King Ranch	6.4	2008-2008		HB528x.811	D1069	HB556x.710	D1067
F-350 Super Duty P/U	King Ranch	6.8	2006-2007	Single Rear Wheels	HB528x.811	D1069	HB529x.710	D1068
F-350 Super Duty P/U	King Ranch	6.8	2006-2007	Dual Rear Wheels	HB528x.811	D1069	HB556x.710	D1067
F-350 Super Duty P/U	King Ranch	6.8	2008-2008		HB528x.811	D1069	HB556x.710	D1067
F-350 Super Duty P/U	Lariat	5.4	2006-2007	Single Rear Wheels	HB528x.811	D1069	HB529x.710	D1068
F-350 Super Duty P/U	Lariat	5.4	2006-2007	Dual Rear Wheels	HB528x.811	D1069	HB556x.710	D1067
F-350 Super Duty P/U	Lariat	5.4	2008-2008		HB528x.811	D1069	HB556x.710	D1067

CODE Breakdown

HB 245 x .631

Insert Compound Code

Make/Model	Submodel	Engine (Liter)	Years	Note	FRONT		REAR	
					Hawk #	FMSI	Hawk #	FMSI
FORD CONT.								
F-350 Super Duty P/U	Lariat	6.0	2006-2007	Single Rear Wheels	HB528x.811	D1069	HB529x.710	D1068
F-350 Super Duty P/U	Lariat	6.0	2006-2007	Dual Rear Wheels	HB528x.811	D1069	HB556x.710	D1067
F-350 Super Duty P/U	Lariat	6.4	2008-2008		HB528x.811	D1069	HB556x.710	D1067
F-350 Super Duty P/U	Lariat	6.8	2006-2007	Single Rear Wheels	HB528x.811	D1069	HB529x.710	D1068
F-350 Super Duty P/U	Lariat	6.8	2006-2007	Dual Rear Wheels	HB528x.811	D1069	HB556x.710	D1067
F-350 Super Duty P/U	Lariat	6.8	2008-2008		HB528x.811	D1069	HB556x.710	D1067
F-350 Super Duty P/U	XL	5.4	2006-2007	Single Rear Wheels	HB528x.811	D1069	HB529x.710	D1068
F-350 Super Duty P/U	XL	5.4	2006-2007	Dual Rear Wheels	HB528x.811	D1069	HB556x.710	D1067
F-350 Super Duty P/U	XL	5.4	2008-2008		HB528x.811	D1069	HB556x.710	D1067
F-350 Super Duty P/U	XL	6.0	2006-2007	Single Rear Wheels	HB528x.811	D1069	HB529x.710	D1068
F-350 Super Duty P/U	XL	6.0	2006-2007	Dual Rear Wheels	HB528x.811	D1069	HB556x.710	D1067
F-350 Super Duty P/U	XL	6.4	2008-2008		HB528x.811	D1069	HB556x.710	D1067
F-350 Super Duty P/U	XL	6.8	2006-2007	Single Rear Wheels	HB528x.811	D1069	HB529x.710	D1068
F-350 Super Duty P/U	XL	6.8	2006-2007	Dual Rear Wheels	HB528x.811	D1069	HB556x.710	D1067
F-350 Super Duty P/U	XL	6.8	2008-2008		HB528x.811	D1069	HB556x.710	D1067
F-350 Super Duty P/U	XLT	5.4	2006-2007	Single Rear Wheels	HB528x.811	D1069	HB529x.710	D1068
F-350 Super Duty P/U	XLT	5.4	2006-2007	Dual Rear Wheels	HB528x.811	D1069	HB556x.710	D1067
F-350 Super Duty P/U	XLT	5.4	2008-2008		HB528x.811	D1069	HB556x.710	D1067
F-350 Super Duty P/U	XLT	6.0	2006-2007	Single Rear Wheels	HB528x.811	D1069	HB529x.710	D1068
F-350 Super Duty P/U	XLT	6.0	2006-2007	Dual Rear Wheels	HB528x.811	D1069	HB556x.710	D1067
F-350 Super Duty P/U	XLT	6.4	2008-2008		HB528x.811	D1069	HB556x.710	D1067
F-350 Super Duty P/U	XLT	6.8	2006-2007	Single Rear Wheels	HB528x.811	D1069	HB529x.710	D1068
F-350 Super Duty P/U	XLT	6.8	2006-2007	Dual Rear Wheels	HB528x.811	D1069	HB556x.710	D1067
F-350 Super Duty P/U	XLT	6.8	2008-2008		HB528x.811	D1069	HB556x.710	D1067
F-350 Super Duty P/U		5.4	1999-2004		HB302x.700	D824	HB303x.685	D757
F-350 Super Duty P/U		5.4	2005-2005	Single Rear Wheels	HB528x.811	D1069	HB529x.710	D1068
F-350 Super Duty P/U		5.4	2005-2005	Dual Rear Wheels	HB528x.811	D1069	HB556x.710	D1067
F-350 Super Duty P/U		6.0	2003-2004		HB302x.700	D824	HB303x.685	D757
F-350 Super Duty P/U		6.0	2005-2005	Single Rear Wheels	HB528x.811	D1069	HB529x.710	D1068
F-350 Super Duty P/U		6.0	2005-2005	Dual Rear Wheels	HB528x.811	D1069	HB556x.710	D1067
F-350 Super Duty P/U		6.8	1999-2004		HB302x.700	D824	HB303x.685	D757
F-350 Super Duty P/U		6.8	2005-2005	Single Rear Wheels	HB528x.811	D1069	HB529x.710	D1068
F-350 Super Duty P/U		6.8	2005-2005	Dual Rear Wheels	HB528x.811	D1069	HB556x.710	D1067
F-350 Super Duty P/U		7.3	1999-2003		HB302x.700	D824	HB303x.685	D757
F-450 Super Duty P/U	Lariat	6.0	2005-2007		HB547x.798	D1066	HB547x.798	D1066
F-450 Super Duty P/U	Lariat	6.8	2005-2007		HB547x.798	D1066	HB547x.798	D1066
F-450 Super Duty P/U	XL	6.0	2005-2007		HB547x.798	D1066	HB547x.798	D1066
F-450 Super Duty P/U	XL	6.8	2005-2007		HB547x.798	D1066	HB547x.798	D1066
F-450 Super Duty P/U	XLT	6.0	2005-2007		HB547x.798	D1066	HB547x.798	D1066
F-450 Super Duty P/U	XLT	6.8	2005-2007		HB547x.798	D1066	HB547x.798	D1066
F-450 Super Duty P/U		6.0	2003-2004		HB335x.815	D777	HB335x.815	D777
F-450 Super Duty P/U		6.8	1999-2004		HB335x.815	D777	HB335x.815	D777
F-450 Super Duty P/U		7.3	1990-1997		HB345x.815	D411	HB345x.815	D411
F-450 Super Duty P/U		7.3	1999-2003		HB335x.815	D777	HB335x.815	D777
F-450 Super Duty P/U		7.5	1990-1997		HB345x.815	D411	HB345x.815	D411
F53 Chassis		7.5	1988-1996		HB345x.815	D411	HB345x.815	D411
F-550 Super Duty P/U	Lariat	6.0	2005-2007		HB547x.798	D1066	HB547x.798	D1066
F-550 Super Duty P/U	Lariat	6.8	2005-2007		HB547x.798	D1066	HB547x.798	D1066
F-550 Super Duty P/U	XL	6.0	2005-2007		HB547x.798	D1066	HB547x.798	D1066
F-550 Super Duty P/U	XL	6.8	2005-2007		HB547x.798	D1066	HB547x.798	D1066
F-550 Super Duty P/U	XLT	6.0	2005-2007		HB547x.798	D1066	HB547x.798	D1066
F-550 Super Duty P/U	XLT	6.8	2005-2007		HB547x.798	D1066	HB547x.798	D1066
F-550 Super Duty P/U		6.0	2003-2004		HB335x.815	D777	HB335x.815	D777

RACE COMPOUND CODES

DTC-70 - U | DTC-05 - H | MT-4 - L | DR-97 - J
 DTC-60 - G | HT-14 - V | Blue 9012 - E | HP Plus - N
 DTC-30 - W | HT-10 - S | Black - M

STREET COMPOUND CODES

HPS Performance Street - F | SuperDuty - P
 Performance Ceramic - Z
 LTS Light Truck & SUV - Y

Make/Model	Submodel	Engine (Liter)	Years	Note	FRONT		REAR	
					Hawk #	FMSI	Hawk #	FMSI
FORD CONT.								
F-550 Super Duty P/U		6.8	2001-2004		HB335x.815	D777	HB335x.815	D777
F-550 Super Duty P/U		7.3	2001-2003		HB335x.815	D777	HB335x.815	D777
F59 Chassis		7.3	1988-1994		HB345x.815	D411	HB345x.815	D411
Focus	LE	2.0	2000-2000		HB346x.713	D816		
Focus	LX	2.0	2000-2000		HB346x.713	D816		
Focus	LX	2.0	2001-2004		HB346x.713	D816	HB430x.547	D886
Focus	LX	2.3	2003-2004		HB346x.713	D816	HB430x.547	D886
Focus	S	2.0	2007-2007		HB519x.682	D1044	HB430x.547	D886
Focus	S2	2.0	2001-2002		HB346x.713	D816	HB430x.547	D886
Focus	SE	2.0	2000-2000		HB346x.713	D816		
Focus	SE	2.0	2001-2004		HB346x.713	D816	HB430x.547	D886
Focus	SE	2.0	2007-2007		HB519x.682	D1044	HB430x.547	D886
Focus	SE	2.3	2003-2004		HB346x.713	D816	HB430x.547	D886
Focus	SES	2.0	2007-2007		HB519x.682	D1044	HB430x.547	D886
Focus	ST	2.3	2007-2007		HB519x.682	D1044	HB430x.547	D886
Focus	Street	2.0	2001-2002		HB346x.713	D816	HB430x.547	D886
Focus	SVT	2.0	2002-2004		HB449x.679	D970	HB430x.547	D886
Focus	ZTS	2.0	2000-2000		HB346x.713	D816		
Focus	ZTS	2.0	2001-2004		HB346x.713	D816	HB430x.547	D886
Focus	ZTS	2.3	2003-2004		HB346x.713	D816	HB430x.547	D886
Focus	ZTW	2.0	2002-2003		HB346x.713	D816	HB430x.547	D886
Focus	ZTW	2.3	2003-2004		HB346x.713	D816	HB430x.547	D886
Focus	ZX3	2.0	2000-2004		HB346x.713	D816	HB430x.547	D886
Focus	ZX3	2.0	2005-2006		HB519x.682	D1044	HB430x.547	D886
Focus	ZX3	2.3	2003-2004		HB346x.713	D816	HB430x.547	D886
Focus	ZX4	2.0	2005-2006		HB519x.682	D1044	HB430x.547	D886
Focus	ZX4 ST	2.3	2005-2006		HB519x.682	D1044	HB430x.547	D886
Focus	ZX5	2.0	2002-2004		HB346x.713	D816	HB430x.547	D886
Focus	ZX5	2.0	2005-2006		HB519x.682	D1044	HB430x.547	D886
Focus	ZX5	2.3	2003-2004		HB346x.713	D816	HB430x.547	D886
Focus	ZXW	2.0	2005-2006		HB519x.682	D1044	HB430x.547	D886
Fuslon	Hybrid	2.3	2008-2008		HB565x.688	D1164	HB564x.567	D1161
Fuslon	S	2.3	2006-2008		HB565x.688	D1164	HB564x.567	D1161
Fuslon	SE	2.3	2006-2008		HB565x.688	D1164	HB564x.567	D1161
Fuslon	SE	3.0	2006-2008		HB565x.688	D1164	HB564x.567	D1161
Fuslon	SEL	2.3	2006-2008		HB565x.688	D1164	HB564x.567	D1161
Fuslon	SEL	3.0	2006-2008		HB565x.688	D1164	HB564x.567	D1161
Gran Torino	Brougham	5.0	1974-1974		HB292x.674	D50		
Gran Torino	Brougham	5.8	1974-1976		HB292x.674	D50		
Gran Torino	Brougham	6.6	1974-1976		HB292x.674	D50		
Gran Torino	Brougham	7.5	1974-1976		HB292x.674	D50		
Gran Torino	Elite	4.1	1974-1974		HB292x.674	D50		
Gran Torino	Elite	5.0	1974-1974		HB292x.674	D50		
Gran Torino	Elite	5.8	1974-1974		HB292x.674	D50		
Gran Torino	Elite	6.6	1974-1974		HB292x.674	D50		
Gran Torino	Elite	7.5	1974-1974		HB292x.674	D50		
Gran Torino	Sport	5.0	1974-1974		HB292x.674	D50		
Gran Torino	Sport	5.8	1974-1975		HB292x.674	D50		
Gran Torino	Sport	6.6	1974-1975		HB292x.674	D50		
Gran Torino	Sport	7.5	1974-1975		HB292x.674	D50		
Gran Torino	Squire	5.0	1974-1974		HB292x.674	D50		
Gran Torino	Squire	5.8	1974-1976		HB292x.674	D50		
Gran Torino	Squire	6.6	1974-1976		HB292x.674	D50		

CODE Breakdown

HB 245 x .631

Insert Compound Code

Make/Model	Submodel	Engine (Liter)	Years	Note	FRONT		REAR	
					Hawk #	FMSI	Hawk #	FMSI
FORD CONT.								
Gran Torino	Squire	7.5	1974-1976		HB292x.674	D50		
Gran Torino		4.1	1974-1974		HB292x.674	D50		
Gran Torino		5.0	1974-1974		HB292x.674	D50		
Gran Torino		5.8	1974-1976		HB292x.674	D50		
Gran Torino		6.6	1974-1976		HB292x.674	D50		
Gran Torino		7.5	1974-1976		HB292x.674	D50		
GT		5.4	2005-2006		HB453x.585	D1001	HB453x.585	D1001
LTD	Brougham	2.3	1983-1986		HB125x.650	D199		
LTD	Brougham	3.3	1983-1983		HB125x.650	D199		
LTD	Brougham	3.8	1983-1986		HB125x.650	D199		
LTD	Brougham	5.0	1972-1972		HB292x.674	D50		
LTD	Brougham	5.0	1984-1985		HB125x.650	D199		
LTD	Brougham	5.8	1972-1976		HB292x.674	D50		
LTD	Brougham	6.6	1972-1976		HB292x.674	D50		
LTD	Brougham	7.0	1972-1973		HB292x.674	D50		
LTD	Brougham	7.5	1972-1976		HB292x.674	D50		
LTD	Country Squire	5.0	1981-1986		HB125x.650	D199		
LTD	Country Squire	5.8	1981-1981		HB125x.650	D199		
LTD	Country Squire	5.8	1983-1986		HB125x.650	D199		
LTD	Crown Victoria	4.2	1981-1982		HB125x.650	D199		
LTD	Crown Victoria	5.0	1981-1986		HB125x.650	D199		
LTD	Crown Victoria	5.8	1981-1986		HB125x.650	D199		
LTD	Landau	5.0	1977-1978		HB292x.674	D50		
LTD	Landau	5.8	1975-1978		HB292x.674	D50		
LTD	Landau	6.6	1975-1978		HB292x.674	D50		
LTD	Landau	7.5	1975-1978		HB292x.674	D50		
LTD	LX	5.0	1985-1985		HB125x.650	D199		
LTD	S	4.2	1981-1982		HB125x.650	D199		
LTD	S	5.0	1981-1982		HB125x.650	D199		
LTD	S	5.8	1981-1982		HB125x.650	D199		
LTD		2.3	1983-1986		HB125x.650	D199		
LTD		3.3	1983-1983		HB125x.650	D199		
LTD		3.8	1983-1986		HB125x.650	D199		
LTD		4.2	1981-1982		HB125x.650	D199		
LTD		5.0	1972-1972		HB292x.674	D50		
LTD		5.0	1977-1978		HB292x.674	D50		
LTD		5.0	1981-1982		HB125x.650	D199		
LTD		5.0	1984-1985		HB125x.650	D199		
LTD		5.8	1972-1978		HB292x.674	D50		
LTD		5.8	1981-1982		HB125x.650	D199		
LTD		6.6	1972-1978		HB292x.674	D50		
LTD		7.0	1972-1973		HB292x.674	D50		
LTD		7.5	1972-1978		HB292x.674	D50		
LTD Crown Victoria	LX	5.0	1987-1991		HB125x.650	D199		
LTD Crown Victoria	S	5.0	1987-1991		HB125x.650	D199		
LTD Crown Victoria		5.0	1987-1991		HB125x.650	D199		
LTD Crown Victoria		5.8	1987-1991		HB125x.650	D199		
LTD II	Brougham	5.0	1977-1977		HB292x.674	D50		
LTD II	Brougham	5.8	1977-1977		HB292x.674	D50		
LTD II	Brougham	6.6	1977-1977		HB292x.674	D50		
LTD II	S	5.0	1977-1979		HB292x.674	D50		
LTD II	S	5.8	1977-1979		HB292x.674	D50		
LTD II	S	6.6	1977-1978		HB292x.674	D50		

RACE COMPOUND CODES

DTC-70 - U | DTC-05 - H | MT-4 - L | DR-97 - J
 DTC-60 - G | HT-14 - V | Blue 9012 - E | HP Plus - N
 DTC-30 - W | HT-10 - S | Black - M

STREET COMPOUND CODES

HPS Performance Street - F | SuperDuty - P
 Performance Ceramic - Z
 LTS Light Truck & SUV - Y

Make/Model	Submodel	Engine (Liter)	Years	Note	FRONT		REAR	
					Hawk #	FMSI	Hawk #	FMSI
FORD CONT.								
LTD II	Squire	5.8	1977-1977		HB292x.674	D50		
LTD II	Squire	6.6	1977-1977		HB292x.674	D50		
LTD II		5.0	1977-1979		HB292x.674	D50		
LTD II		5.8	1977-1979		HB292x.674	D50		
LTD II		6.6	1977-1978		HB292x.674	D50		
Mustang	Bullitt	4.6	2001-2001		HB111x.610	D412	HB183x.660	D627
Mustang	Bullitt	4.6	2008-2008		HB484x.670	D1081	HB485x.656	D1082
Mustang	Cobra	4.6	1996-1999		HB111x.610	D412	HB183x.585	D627
Mustang	Cobra	4.6	2001-2001		HB111x.610	D412	HB183x.585	D627
Mustang	Cobra	4.6	2003-2004		HB111x.610	D412	HB183x.585	D627
Mustang	Cobra	5.0	1994-1994		HB111x.610	D412	HB183x.585	D627
Mustang	Cobra R	5.8	1995-1995		HB111x.610	D412	HB183x.585	D627
Mustang	Cobra SVT	5.0	1995-1995		HB111x.610	D412	HB183x.585	D627
Mustang	GT	4.6	1996-1998		HB182x.660	D600	HB183x.660	D627
Mustang	GT	4.6	1999-2004		HB274x.610	D804	HB183x.660	D627
Mustang	GT	4.6	2005-2008		HB484x.670	D1081	HB485x.656	D1082
Mustang	GT	5.0	1985-1993		HB263x.650	D431		
Mustang	GT	5.0	1994-1995		HB182x.660	D600	HB183x.660	D627
Mustang	GTS	5.0	1995-1995		HB182x.660	D600	HB183x.660	D627
Mustang	LX	2.3	1985-1986		HB263x.650	D431		
Mustang	LX	3.8	1985-1986		HB263x.650	D431		
Mustang	LX	5.0	1985-1993		HB263x.650	D431		
Mustang	Mach 1	4.6	2003-2004		HB111x.610	D412	HB183x.660	D627
Mustang	Shelby GT	4.6	2007-2008		HB484x.670	D1081	HB485x.656	D1082
Mustang	Shelby GT500	5.4	2007-2008		HB453x.585	D1001	HB485x.656	D1082
Mustang	SVO	2.3	1984-1984		HB125x.650	D199		
Mustang	SVT Cobra R	5.4	2000-2000		HB111x.610	D412	HB183x.585	D627
Mustang	V6	4.0	2008-2008		HB484x.670	D1081	HB485x.656	D1082
Probe	GT	2.5	1993-1997		HB211x.606	D637	HB212x.535	D584
Probe		2.0	1993-1997		HB211x.606	D637	HB212x.535	D584
Ranchero	500	5.0	1977-1979		HB292x.674	D50		
Ranchero	500	5.8	1976-1979		HB292x.674	D50		
Ranchero	500	6.6	1976-1978		HB292x.674	D50		
Ranchero	500	7.5	1976-1977		HB292x.674	D50		
Ranchero	GT	5.0	1977-1979		HB292x.674	D50		
Ranchero	GT	5.8	1976-1979		HB292x.674	D50		
Ranchero	GT	6.6	1976-1978		HB292x.674	D50		
Ranchero	GT	7.5	1976-1977		HB292x.674	D50		
Ranchero	Squire	5.0	1977-1979		HB292x.674	D50		
Ranchero	Squire	5.8	1976-1979		HB292x.674	D50		
Ranchero	Squire	6.6	1976-1978		HB292x.674	D50		
Ranchero	Squire	7.5	1976-1976		HB292x.674	D50		
Ranger	Edge	3.0	2001-2002		HB283x.650	D652		
Ranger	Edge	3.0	2003-2005		HB472x.650	D833		
Ranger	Edge	4.0	2001-2002		HB283x.650	D652		
Ranger	Edge	4.0	2003-2005		HB472x.650	D833		
Ranger	FX4	4.0	2005-2008		HB472x.650	D833		
Ranger	Sport	2.3	2008-2008		HB472x.650	D833		
Ranger	Sport	3.0	2006-2008		HB472x.650	D833		
Ranger	Sport	4.0	2006-2008		HB472x.650	D833		
Ranger	STX	2.3	2007-2007		HB472x.650	D833		
Ranger	STX	3.0	2006-2008		HB472x.650	D833		
Ranger	STX	4.0	2006-2008		HB472x.650	D833		

CODE Breakdown

HB 245 x .631

Insert Compound Code

Make/Model	Submodel	Engine (Liter)	Years	Note	FRONT		REAR	
					Hawk #	FMSI	Hawk #	FMSI
FORD CONT.								
Ranger	Super	2.3	1987-1994		HB279x.594	D249		
Ranger	Super	2.3	1995-1997		HB283x.650	D652		
Ranger	Super	2.5	1998-1998		HB283x.650	D652		
Ranger	Super	2.9	1987-1992		HB279x.594	D249		
Ranger	Super	3.0	1991-1994		HB279x.594	D249		
Ranger	Super	3.0	1995-1998		HB283x.650	D652		
Ranger	Super	4.0	1990-1994		HB279x.594	D249		
Ranger	Super	4.0	1995-1998		HB283x.650	D652		
Ranger	XL	2.3	2005-2008		HB472x.650	D833		
Ranger	XL	3.0	2005-2008		HB472x.650	D833		
Ranger	XL	4.0	2005-2008		HB472x.650	D833		
Ranger	XLT	2.3	2005-2008		HB472x.650	D833		
Ranger	XLT	3.0	2005-2008		HB472x.650	D833		
Ranger	XLT	4.0	2005-2008		HB472x.650	D833		
Ranger		2.0	1983-1988		HB279x.594	D249		
Ranger		2.2	1983-1984		HB279x.594	D249		
Ranger		2.3	1983-1994		HB279x.594	D249		
Ranger		2.3	1995-1997		HB283x.650	D652		
Ranger		2.3	2001-2002		HB283x.650	D652		
Ranger		2.3	2003-2004		HB472x.650	D833		
Ranger		2.5	1998-2001		HB283x.650	D652		
Ranger		2.8	1983-1985		HB279x.594	D249		
Ranger		2.9	1986-1992		HB279x.594	D249		
Ranger		3.0	1991-1994		HB279x.594	D249		
Ranger		3.0	1995-2002		HB283x.650	D652		
Ranger		3.0	2003-2004		HB472x.650	D833		
Ranger		4.0	1990-1994		HB279x.594	D249		
Ranger		4.0	1995-2002		HB283x.650	D652		
Ranger		4.0	2003-2004		HB472x.650	D833		
Ranger			1998-2000		HB283x.650	D652		
Taurus	G	3.0	1996-1997		HB347x.689	D601		
Taurus	GL	2.5	1987-1988		HB259x.620	D324		
Taurus	GL	2.5	1989-1991		HB240x.620	D421		
Taurus	GL	3.0	1987-1988		HB259x.620	D324		
Taurus	GL	3.0	1989-1993		HB240x.620	D421		
Taurus	GL	3.0	1994-1998		HB347x.689	D601		
Taurus	GL	3.8	1988-1988		HB259x.620	D324		
Taurus	GL	3.8	1989-1993		HB240x.620	D421		
Taurus	GL	3.8	1994-1995		HB347x.689	D601		
Taurus	L	2.5	1987-1988		HB259x.620	D324		
Taurus	L	2.5	1989-1990		HB240x.620	D421		
Taurus	L	3.0	1987-1988		HB259x.620	D324		
Taurus	L	3.0	1989-1992		HB240x.620	D421		
Taurus	L	3.8	1988-1988		HB259x.620	D324		
Taurus	L	3.8	1991-1992		HB240x.620	D421		
Taurus	LX	2.5	1987-1987		HB259x.620	D324		
Taurus	LX	3.0	1987-1988		HB259x.620	D324		
Taurus	LX	3.0	1989-1993		HB240x.620	D421		
Taurus	LX	3.0	1994-1998		HB347x.689	D601		
Taurus	LX	3.8	1988-1988		HB259x.620	D324		
Taurus	LX	3.8	1989-1993		HB240x.620	D421		
Taurus	LX	3.8	1994-1995		HB347x.689	D601		
Taurus	MT5	2.5	1987-1988		HB259x.620	D324		

RACE COMPOUND CODES

DTC-70 - U	DTC-05 - H	MT-4 - L	DR-97 - J
DTC-60 - G	HT-14 - V	Blue 9012 - E	HP Plus - N
DTC-30 - W	HT-10 - S	Black - M	

STREET COMPOUND CODES

HPS Performance Street - F	SuperDuty - P
Performance Ceramic - Z	
LTS Light Truck & SUV - Y	

Make/Model	Submodel	Engine		Note	FRONT		REAR	
		(Liter)	Years		Hawk #	FMSI	Hawk #	FMSI
FORD CONT.								
Taurus	MT5	3.0	1987-1988		HB259x.620	D324		
Taurus	SE	3.0	1995-1995		HB347x.689	D601		
Taurus	SE	3.0	2006-2006		HB416x.689	D598		
Taurus	SE	3.8	1995-1995		HB347x.689	D601		
Taurus	SEL	3.0	2006-2006		HB416x.689	D598		
Taurus	SHO	3.0	1989-1992		HB240x.620	D421	HB580x.627	D545
Taurus	SHO	3.0	1993-1993		HB240x.620	D421	HB417x.659	D610
Taurus	SHO	3.0	1994-1994		HB347x.689	D601	HB417x.659	D610
Taurus	SHO	3.2	1993-1993		HB240x.620	D421	HB417x.659	D610
Taurus	SHO	3.2	1994-1994		HB347x.689	D601	HB417x.659	D610
Taurus	SHO	3.4	1998-1999		HB416x.689	D598	HB417x.659	D610
Taurus		2.5	1986-1986		HB259x.620	D324		
Taurus		3.0	1986-1986		HB259x.620	D324		
Taurus		3.0	1999-2000		HB347x.689	D601	HB417x.659	D610
Taurus		3.0	2001-2002	Police	HB347x.689	D601	HB417x.659	D610
Taurus		3.0	2001-2002	Except Police	HB416x.689	D598	HB417x.659	D610
Taurus		3.0	2003-2005		HB416x.689	D598	HB417x.659	D610
Thunderbird	LX	3.8	1989-1992		HB240x.620	D421		
Thunderbird	LX	3.8	1993-1997		HB182x.660	D600		
Thunderbird	LX	4.6	1994-1997		HB182x.660	D600		
Thunderbird	LX	5.0	1991-1992		HB240x.620	D421		
Thunderbird	LX	5.0	1993-1993		HB182x.660	D600		
Thunderbird	SC	3.8	1989-1992		HB240x.620	D421	HB580x.627	D545
Thunderbird	SC	3.8	1993-1995		HB182x.660	D600		
Thunderbird		2.3	1987-1988		HB263x.650	D431		
Thunderbird		3.8	1987-1988		HB263x.650	D431		
Thunderbird		3.8	1989-1992		HB240x.620	D421		
Thunderbird		3.9	2002-2005		HB376x.665	D805	HB428x.650	D806
Thunderbird		5.0	1977-1978		HB292x.674	D50		
Thunderbird		5.0	1987-1988		HB263x.650	D431		
Thunderbird		5.0	1991-1992		HB240x.620	D421		
Thunderbird		5.8	1977-1978		HB292x.674	D50		
Thunderbird		6.6	1972-1972		HB292x.674	D50		
Thunderbird		6.6	1977-1978		HB292x.674	D50		
Thunderbird		7.0	1972-1973		HB292x.674	D50		
Thunderbird		7.5	1972-1976		HB292x.674	D50		
Torino		5.8	1975-1976		HB292x.674	D50		
Torino		6.6	1975-1976		HB292x.674	D50		
Torino		7.5	1975-1976		HB292x.674	D50		
Windstar		3.0	1995-1998		HB347x.689	D601		
Windstar		3.0	1999-2000		HB342x.701	D803	HB284x.575	D664
Windstar		3.8	1995-1998		HB347x.689	D601		
Windstar		3.8	1999-2003		HB342x.701	D803	HB284x.575	D664
ZX2	S/R	2.0	1999-2000		HB246x.567	D473	HB159x.492	D636
ZX2		2.0	1998-2003		HB246x.567	D473	HB159x.492	D636
FREIGHTLINER								
Sprinter 2500		2.7	2004-2005		HB575x.750	D1136	HB575x.750	D1136
Sprinter 2500		2.7	2006-2006	15 in. Wheels. w/Bosch Calipers	HB480x.750	D949	HB479x.700	D928
Sprinter 2500		2.7	2006-2006	16 in. Wheels. w/Teves Calipers	HB480x.750	D949	HB481x.750	D1006
Sprinter 2500		2.7	2006-2006	15 in. Wheels. w/Bosch Calipers	HB575x.750	D1136	HB479x.700	D928
Sprinter 2500		2.7	2006-2006	16 in. Wheels. w/Teves Calipers	HB575x.750	D1136	HB481x.750	D1006
Sprinter 3500		2.7	2006-2006	15 in. Wheels. w/Bosch Calipers	HB480x.750	D949	HB479x.700	D928

CODE Breakdown

HB 245 x .631

Insert Compound Code

Make/Model	Submodel	Engine (Liter)	Years	Note	FRONT		REAR	
					Hawk #	FMSI	Hawk #	FMSI
FREIGHTLINER CONT.								
Sprinter 3500		2.7	2006-2006	16 in. Wheels. w/Teves Calipers	HB480x.750	D949	HB481x.750	D1006
Sprinter 3500		2.7	2006-2006	15 in. Wheels. w/Bosch Calipers	HB575x.750	D1136	HB479x.700	D928
Sprinter 3500		2.7	2006-2006	16 in. Wheels. w/Teves Calipers	HB575x.750	D1136	HB481x.750	D1006
GEO								
Prizm	GSi	1.6	1990-1992		HB191x.590	D242	HB401x.587	D325
Prizm	LSi	1.6	1990-1992		HB191x.590	D242		
Prizm	LSi	1.6	1993-1997		HB310x.689	D562		
Prizm	LSi	1.8	1993-1997		HB310x.689	D562		
Prizm		1.6	1993-1997		HB310x.689	D562		
Storm	2+2	1.6	1990-1993		HB148x.560	D525		
Storm	GSi	1.6	1990-1991		HB148x.560	D525		
Storm	GSi	1.8	1992-1993		HB148x.560	D525		
Storm		1.6	1990-1993		HB148x.560	D525		
Tracker		1.6	1996-1997		HB384x.587	D556		
GMC								
C15/C1500 Pickup	Big Ten	4.1	1977-1980		HB103x.590	D313		
C15/C1500 Pickup	Big Ten	4.8	1978-1978		HB103x.590	D313		
C15/C1500 Pickup	Big Ten	4.8	1980-1980		HB103x.590	D313		
C15/C1500 Pickup	Big Ten	5.0	1978-1980		HB103x.590	D313		
C15/C1500 Pickup	Big Ten	5.7	1977-1980		HB103x.590	D313		
C15/C1500 Pickup	Big Ten	6.6	1980-1980		HB103x.590	D313		
C15/C1500 Pickup	Big Ten	7.4	1977-1980		HB103x.590	D313		
C15/C1500 Pickup		4.1	1970-1984		HB103x.590	D313		
C15/C1500 Pickup		4.3	1985-1985		HB103x.590	D313		
C15/C1500 Pickup		4.8	1970-1971		HB103x.590	D313		
C15/C1500 Pickup		4.8	1973-1980		HB103x.590	D313		
C15/C1500 Pickup		5.0	1970-1973		HB103x.590	D313		
C15/C1500 Pickup		5.0	1976-1985		HB103x.590	D313		
C15/C1500 Pickup		5.7	1970-1985		HB103x.590	D313		
C15/C1500 Pickup		6.2	1982-1985		HB103x.590	D313		
C15/C1500 Pickup		6.6	1970-1972		HB103x.590	D313		
C15/C1500 Pickup		6.6	1976-1976		HB103x.590	D313		
C15/C1500 Pickup		6.6	1978-1980		HB103x.590	D313		
C15/C1500 Pickup		7.4	1973-1980		HB103x.590	D313		
C15/C1500 Suburban		4.1	1970-1980		HB103x.590	D313		
C15/C1500 Suburban		4.8	1970-1971		HB103x.590	D313		
C15/C1500 Suburban		4.8	1973-1974		HB103x.590	D313		
C15/C1500 Suburban		5.0	1970-1973		HB103x.590	D313		
C15/C1500 Suburban		5.0	1976-1985		HB103x.590	D313		
C15/C1500 Suburban		5.7	1970-1985		HB103x.590	D313		
C15/C1500 Suburban		6.2	1982-1985		HB103x.590	D313		
C15/C1500 Suburban		6.6	1970-1972		HB103x.590	D313		
C15/C1500 Suburban		7.4	1973-1980		HB103x.590	D313		
C1500 Pickup	Sierra	4.3	1989-1991	Extended Cab	HB332x.654	D369		
C1500 Pickup	Sierra	4.3	1989-1991	Regular Cab	HB356x.654	D368		
C1500 Pickup	Sierra	4.3	1992-1997		HB332x.654	D369		
C1500 Pickup	Sierra	5.0	1989-1991	Extended Cab	HB332x.654	D369		
C1500 Pickup	Sierra	5.0	1989-1991	Regular Cab	HB356x.654	D368		
C1500 Pickup	Sierra	5.0	1992-1997		HB332x.654	D369		
C1500 Pickup	Sierra	5.7	1989-1991	Extended Cab	HB332x.654	D369		
C1500 Pickup	Sierra	5.7	1989-1991	Regular Cab	HB356x.654	D368		
C1500 Pickup	Sierra	5.7	1992-1997		HB332x.654	D369		

RACE COMPOUND CODES

DTC-70 - U | DTC-05 - H | MT-4 - L | DR-97 - J
 DTC-60 - G | HT-14 - V | Blue 9012 - E | HP Plus - N
 DTC-30 - W | HT-10 - S | Black - M

STREET COMPOUND CODES

HPS Performance Street - F | SuperDuty - P
 Performance Ceramic - Z
 LTS Light Truck & SUV - Y

Make/ Model	Submodel	Engine (Liter)	Years	Note	FRONT		REAR	
					Hawk #	FMSI	Hawk #	FMSI
GMC CONT.								
C1500 Pickup	Sierra	6.2	1989-1991	Extended Cab	HB332x.654	D369		
C1500 Pickup	Sierra	6.2	1989-1991	Regular Cab	HB356x.654	D368		
C1500 Pickup	Sierra	6.2	1992-1993		HB332x.654	D369		
C1500 Pickup	Sierra	6.5	1994-1997		HB332x.654	D369		
C1500 Pickup	Sierra XC	4.3	1989-1991	Extended Cab	HB332x.654	D369		
C1500 Pickup	Sierra XC	4.3	1992-1997		HB332x.654	D369		
C1500 Pickup	Sierra XC	5.0	1989-1991	Extended Cab	HB332x.654	D369		
C1500 Pickup	Sierra XC	5.0	1992-1997		HB332x.654	D369		
C1500 Pickup	Sierra XC	5.7	1989-1991	Extended Cab	HB332x.654	D369		
C1500 Pickup	Sierra XC	5.7	1992-1997		HB332x.654	D369		
C1500 Pickup	Sierra XC	6.2	1989-1991	Extended Cab	HB332x.654	D369		
C1500 Pickup	Sierra XC	6.2	1992-1993		HB332x.654	D369		
C1500 Pickup	Sierra XC	6.5	1994-1997		HB332x.654	D369		
C1500 Pickup		4.3	1988-1988	Extended Cab	HB332x.654	D369		
C1500 Pickup		4.3	1988-1988	Regular Cab	HB356x.654	D368		
C1500 Pickup		4.3	1998-1998		HB332x.654	D369		
C1500 Pickup		5.0	1988-1988	Extended Cab	HB332x.654	D369		
C1500 Pickup		5.0	1988-1988	Regular Cab	HB356x.654	D368		
C1500 Pickup		5.0	1998-1999		HB332x.654	D369		
C1500 Pickup		5.7	1988-1988	Extended Cab	HB332x.654	D369		
C1500 Pickup		5.7	1988-1988	Regular Cab	HB356x.654	D368		
C1500 Pickup		5.7	1998-1999		HB332x.654	D369		
C1500 Pickup		6.2	1988-1988	Extended Cab	HB332x.654	D369		
C1500 Pickup		6.2	1988-1988	Regular Cab	HB356x.654	D368		
C1500 Suburban		5.7	1992-1999		HB332x.654	D369		
C1500 Suburban		6.5	1995-1999		HB332x.654	D369		
C25/C2500 Pickup		4.1	1970-1975		HB103x.590	D313		
C25/C2500 Pickup		4.1	1977-1978		HB103x.590	D313		
C25/C2500 Pickup		4.1	1979-1984	w/11 in. Drums	HB103x.590	D313		
C25/C2500 Pickup		4.1	1979-1984	w/13 in. Drums	HB131x.595	D614		
C25/C2500 Pickup		4.3	1985-1985	w/11 in. Drums	HB103x.590	D313		
C25/C2500 Pickup		4.3	1985-1986	w/13 in. Drums	HB131x.595	D614		
C25/C2500 Pickup		4.8	1970-1978		HB103x.590	D313		
C25/C2500 Pickup		4.8	1979-1985	w/11 in. Drums	HB103x.590	D313		
C25/C2500 Pickup		4.8	1979-1986	w/13 in. Drums	HB131x.595	D614		
C25/C2500 Pickup		5.0	1970-1973		HB103x.590	D313		
C25/C2500 Pickup		5.0	1977-1978		HB103x.590	D313		
C25/C2500 Pickup		5.0	1979-1985	w/11 in. Drums	HB103x.590	D313		
C25/C2500 Pickup		5.0	1979-1986	w/13 in. Drums	HB131x.595	D614		
C25/C2500 Pickup		5.7	1970-1978		HB103x.590	D313		
C25/C2500 Pickup		5.7	1979-1985	w/11 in. Drums	HB103x.590	D313		
C25/C2500 Pickup		5.7	1979-1986	w/13 in. Drums	HB131x.595	D614		
C25/C2500 Pickup		6.2	1982-1985	w/11 in. Drums	HB103x.590	D313		
C25/C2500 Pickup		6.2	1982-1986	w/13 in. Drums	HB131x.595	D614		
C25/C2500 Pickup		6.6	1970-1972		HB103x.590	D313		
C25/C2500 Pickup		6.6	1976-1978		HB103x.590	D313		
C25/C2500 Pickup		6.6	1979-1979	w/11 in. Drums	HB103x.590	D313		
C25/C2500 Pickup		6.6	1979-1979	w/13 in. Drums	HB131x.595	D614		
C25/C2500 Pickup		7.4	1973-1977		HB103x.590	D313		
C25/C2500 Pickup		7.4	1978-1985	w/11 in. Drums	HB103x.590	D313		
C25/C2500 Pickup		7.4	1979-1986	w/13 in. Drums	HB131x.595	D614		
C25/C2500 Suburban		4.1	1970-1974		HB103x.590	D313		
C25/C2500 Suburban		4.8	1970-1978		HB103x.590	D313		

CODE Breakdown

HB 245 x .631

Insert Compound Code

Make/Model	Submodel	Engine (Liter)	Years	Note	FRONT		REAR	
					Hawk #	FMSI	Hawk #	FMSI
GMC CONT.								
C25/C2500 Suburban		4.8	1979-1982	w/11 in. Drums	HB103x.590	D313		
C25/C2500 Suburban		4.8	1979-1982	w/13 in. Drums	HB131x.595	D614		
C25/C2500 Suburban		4.8	1984-1985	w/11 in. Drums	HB103x.590	D313		
C25/C2500 Suburban		4.8	1984-1985	w/13 in. Drums	HB131x.595	D614		
C25/C2500 Suburban		4.8	1986-1986		HB131x.595	D614		
C25/C2500 Suburban		5.0	1970-1973		HB103x.590	D313		
C25/C2500 Suburban		5.0	1977-1978		HB103x.590	D313		
C25/C2500 Suburban		5.0	1982-1985	w/11 in. Drums	HB103x.590	D313		
C25/C2500 Suburban		5.0	1982-1985	w/13 in. Drums	HB131x.595	D614		
C25/C2500 Suburban		5.0	1986-1986		HB131x.595	D614		
C25/C2500 Suburban		5.7	1970-1972		HB103x.590	D313		
C25/C2500 Suburban		5.7	1974-1978		HB103x.590	D313		
C25/C2500 Suburban		5.7	1979-1985	w/11 in. Drums	HB103x.590	D313		
C25/C2500 Suburban		5.7	1979-1985	w/13 in. Drums	HB131x.595	D614		
C25/C2500 Suburban		5.7	1986-1986		HB131x.595	D614		
C25/C2500 Suburban		6.2	1982-1985	w/11 in. Drums	HB103x.590	D313		
C25/C2500 Suburban		6.2	1982-1985	w/13 in. Drums	HB131x.595	D614		
C25/C2500 Suburban		6.2	1986-1986		HB131x.595	D614		
C25/C2500 Suburban		6.6	1970-1972		HB103x.590	D313		
C25/C2500 Suburban		6.6	1978-1978		HB103x.590	D313		
C25/C2500 Suburban		6.6	1980-1980	w/11 in. Drums	HB103x.590	D313		
C25/C2500 Suburban		6.6	1980-1980	w/13 in. Drums	HB131x.595	D614		
C25/C2500 Suburban		7.4	1974-1978		HB103x.590	D313		
C25/C2500 Suburban		7.4	1979-1985	w/11 in. Drums	HB103x.590	D313		
C25/C2500 Suburban		7.4	1979-1985	w/13 in. Drums	HB131x.595	D614		
C25/C2500 Suburban		7.4	1986-1986		HB131x.595	D614		
C2500 Pickup	Sierra	4.3	1989-1995	8600 lbs. GVWR	HB296x.670	D370		
C2500 Pickup	Sierra	4.3	1989-1995	7200 lbs. GVWR	HB332x.654	D369		
C2500 Pickup	Sierra	5.0	1989-1998	8600 lbs. GVWR	HB296x.670	D370		
C2500 Pickup	Sierra	5.0	1989-1998	7200 lbs. GVWR	HB332x.654	D369		
C2500 Pickup	Sierra	5.7	1989-1998	8600 lbs. GVWR	HB296x.670	D370		
C2500 Pickup	Sierra	5.7	1989-1998	7200 lbs. GVWR	HB332x.654	D369		
C2500 Pickup	Sierra	6.2	1989-1993	8600 lbs. GVWR	HB296x.670	D370		
C2500 Pickup	Sierra	6.2	1989-1993	7200 lbs. GVWR	HB332x.654	D369		
C2500 Pickup	Sierra	6.5	1992-1998	8600 lbs. GVWR	HB296x.670	D370		
C2500 Pickup	Sierra	6.5	1992-1998	7200 lbs. GVWR	HB332x.654	D369		
C2500 Pickup	Sierra	7.4	1991-1998	8600 lbs. GVWR	HB296x.670	D370		
C2500 Pickup	Sierra	7.4	1991-1998	7200 lbs. GVWR	HB332x.654	D369		
C2500 Pickup	Sierra XC	4.3	1989-1993	8600 lbs. GVWR	HB296x.670	D370		
C2500 Pickup	Sierra XC	4.3	1989-1993	7200 lbs. GVWR	HB332x.654	D369		
C2500 Pickup	Sierra XC	5.0	1989-1998	8600 lbs. GVWR	HB296x.670	D370		
C2500 Pickup	Sierra XC	5.0	1989-1998	7200 lbs. GVWR	HB332x.654	D369		
C2500 Pickup	Sierra XC	5.7	1989-1998	8600 lbs. GVWR	HB296x.670	D370		
C2500 Pickup	Sierra XC	5.7	1989-1998	7200 lbs. GVWR	HB332x.654	D369		
C2500 Pickup	Sierra XC	6.2	1989-1993	8600 lbs. GVWR	HB296x.670	D370		
C2500 Pickup	Sierra XC	6.2	1989-1993	7200 lbs. GVWR	HB332x.654	D369		
C2500 Pickup	Sierra XC	6.5	1993-1998	8600 lbs. GVWR	HB296x.670	D370		
C2500 Pickup	Sierra XC	6.5	1993-1998	7200 lbs. GVWR	HB332x.654	D369		
C2500 Pickup	Sierra XC	7.4	1991-1998	8600 lbs. GVWR	HB296x.670	D370		
C2500 Pickup	Sierra XC	7.4	1991-1998	7200 lbs. GVWR	HB332x.654	D369		
C2500 Pickup		4.3	1988-1988	8600 lbs. GVWR	HB296x.670	D370		
C2500 Pickup		4.3	1988-1988	7200 lbs. GVWR	HB332x.654	D369		
C2500 Pickup		5.0	1988-1988	8600 lbs. GVWR	HB296x.670	D370		

RACE COMPOUND CODES

DTC-70 - U	DTC-05 - H	MT-4 - L	DR-97 - J
DTC-60 - G	HT-14 - V	Blue 9012 - E	HP Plus - N
DTC-30 - W	HT-10 - S	Black - M	

STREET COMPOUND CODES

HPS Performance Street - F	SuperDuty - P
Performance Ceramic - Z	
LTS Light Truck & SUV - Y	

Make/Model	Submodel	Engine (Liter)	Years	Note	FRONT		REAR	
					Hawk #	FMSI	Hawk #	FMSI
GMC CONT.								
C2500 Pickup		5.0	1988-1988	7200 lbs. GVWR	HB332x.654	D369		
C2500 Pickup		5.7	1988-1988	8600 lbs. GVWR	HB296x.670	D370		
C2500 Pickup		5.7	1988-1988	7200 lbs. GVWR	HB332x.654	D369		
C2500 Pickup		5.7	1999-2000		HB296x.670	D370		
C2500 Pickup		6.2	1988-1988	8600 lbs. GVWR	HB296x.670	D370		
C2500 Pickup		6.2	1988-1988	7200 lbs. GVWR	HB332x.654	D369		
C2500 Pickup		6.5	1999-2000		HB296x.670	D370		
C2500 Pickup		7.4	1999-2000		HB296x.670	D370		
C2500 Suburban		5.7	1992-1999		HB296x.670	D370		
C2500 Suburban		6.5	1994-1999		HB296x.670	D370		
C2500 Suburban		7.4	1992-1999		HB296x.670	D370		
C35/C3500 Pickup		4.1	1970-1975		HB103x.590	D313		
C35/C3500 Pickup		4.1	1978-1978		HB103x.590	D313		
C35/C3500 Pickup		4.1	1979-1980	w/13 x 2.5 in. Drums	HB103x.590	D313		
C35/C3500 Pickup		4.1	1979-1980	w/13 x 3.5 in. Drums	HB131x.595	D614		
C35/C3500 Pickup		4.1	1979-1980	w/13 x 3.5 in. Drums	HB337x.791	D149		
C35/C3500 Pickup		4.8	1970-1978		HB103x.590	D313		
C35/C3500 Pickup		4.8	1979-1985	w/13 x 2.5 in. Drums	HB103x.590	D313		
C35/C3500 Pickup		4.8	1979-1986	w/13 x 3.5 in. Drums	HB131x.595	D614		
C35/C3500 Pickup		4.8	1979-1986	w/13 x 3.5 in. Drums	HB337x.791	D149		
C35/C3500 Pickup		5.0	1970-1973		HB103x.590	D313		
C35/C3500 Pickup		5.0	1978-1978		HB103x.590	D313		
C35/C3500 Pickup		5.0	1986-1986	w/13 x 3.5 in. Drums	HB131x.595	D614		
C35/C3500 Pickup		5.0	1986-1986	w/13 x 3.5 in. Drums	HB337x.791	D149		
C35/C3500 Pickup		5.7	1970-1978		HB103x.590	D313		
C35/C3500 Pickup		5.7	1979-1985	w/13 x 2.5 in. Drums	HB103x.590	D313		
C35/C3500 Pickup		5.7	1979-1986	w/13 x 3.5 in. Drums	HB131x.595	D614		
C35/C3500 Pickup		5.7	1979-1986	w/13 x 3.5 in. Drums	HB337x.791	D149		
C35/C3500 Pickup		6.2	1982-1985	w/13 x 2.5 in. Drums	HB103x.590	D313		
C35/C3500 Pickup		6.2	1982-1986	w/13 x 3.5 in. Drums	HB131x.595	D614		
C35/C3500 Pickup		6.2	1982-1986	w/13 x 3.5 in. Drums	HB337x.791	D149		
C35/C3500 Pickup		6.6	1970-1972		HB103x.590	D313		
C35/C3500 Pickup		6.6	1976-1978		HB103x.590	D313		
C35/C3500 Pickup		6.6	1979-1979	w/13 x 2.5 in. Drums	HB103x.590	D313		
C35/C3500 Pickup		6.6	1979-1979	w/13 x 3.5 in. Drums	HB131x.595	D614		
C35/C3500 Pickup		6.6	1979-1979	w/13 x 3.5 in. Drums	HB337x.791	D149		
C35/C3500 Pickup		7.4	1973-1978		HB103x.590	D313		
C35/C3500 Pickup		7.4	1979-1985	w/13 x 2.5 in. Drums	HB103x.590	D313		
C35/C3500 Pickup		7.4	1979-1986	w/13 x 3.5 in. Drums	HB131x.595	D614		
C35/C3500 Pickup		7.4	1979-1986	w/13 x 3.5 in. Drums	HB337x.791	D149		
C3500 Pickup	Sierra	5.7	1989-1989		HB296x.670	D370		
C3500 Pickup	Sierra	5.7	1990-1991	Drum	HB296x.670	D370		
C3500 Pickup	Sierra	5.7	1990-1997	Drum	HB298x.787	D459		
C3500 Pickup	Sierra	5.7	1992-1995	Disc	HB337x.791	D149	HB337x.791	D149
C3500 Pickup	Sierra	5.7	1992-1997	Drum	HB296x.670	D370		
C3500 Pickup	Sierra	6.2	1989-1989		HB296x.670	D370		
C3500 Pickup	Sierra	6.2	1990-1991	Drum	HB296x.670	D370		
C3500 Pickup	Sierra	6.2	1990-1993	Drum	HB298x.787	D459		
C3500 Pickup	Sierra	6.2	1992-1993	Drum	HB296x.670	D370		
C3500 Pickup	Sierra	6.2	1992-1993	Disc	HB337x.791	D149	HB337x.791	D149
C3500 Pickup	Sierra	6.5	1992-1995	Disc	HB337x.791	D149	HB337x.791	D149
C3500 Pickup	Sierra	6.5	1992-1997	Drum	HB296x.670	D370		
C3500 Pickup	Sierra	6.5	1992-1997	Drum	HB298x.787	D459		

CODE Breakdown

HB 245 x .631

Insert Compound Code

Make/Model	Submodel	Engine (Liter)	Years	Note	FRONT		REAR	
					Hawk #	FMSI	Hawk #	FMSI
GMC CONT.								
C3500 Pickup	Sierra	7.4	1989-1989		HB296x.670	D370		
C3500 Pickup	Sierra	7.4	1990-1991	Drum	HB296x.670	D370		
C3500 Pickup	Sierra	7.4	1990-1997	Drum	HB298x.787	D459		
C3500 Pickup	Sierra	7.4	1992-1995	Disc	HB337x.791	D149	HB337x.791	D149
C3500 Pickup	Sierra	7.4	1992-1997	Drum	HB296x.670	D370		
C3500 Pickup	Sierra XC	5.7	1989-1989		HB296x.670	D370		
C3500 Pickup	Sierra XC	5.7	1990-1997	Drum	HB296x.670	D370		
C3500 Pickup	Sierra XC	5.7	1990-1997	Drum	HB298x.787	D459		
C3500 Pickup	Sierra XC	6.2	1989-1989		HB296x.670	D370		
C3500 Pickup	Sierra XC	6.2	1990-1993	Drum	HB296x.670	D370		
C3500 Pickup	Sierra XC	6.2	1990-1993	Drum	HB298x.787	D459		
C3500 Pickup	Sierra XC	6.5	1992-1997	Drum	HB296x.670	D370		
C3500 Pickup	Sierra XC	6.5	1992-1997	Drum	HB298x.787	D459		
C3500 Pickup	Sierra XC	7.4	1989-1989		HB296x.670	D370		
C3500 Pickup	Sierra XC	7.4	1990-1997	Drum	HB296x.670	D370		
C3500 Pickup	Sierra XC	7.4	1990-1997	Drum	HB298x.787	D459		
C3500 Pickup		5.7	1988-1988		HB296x.670	D370		
C3500 Pickup		5.7	1988-2000	Drum	HB296x.670	D370		
C3500 Pickup		5.7	1988-2000	Drum	HB298x.787	D459		
C3500 Pickup		6.2	1988-1988		HB296x.670	D370		
C3500 Pickup		6.5	1988-2000	Drum	HB296x.670	D370		
C3500 Pickup		6.5	1988-2000	Drum	HB298x.787	D459		
C3500 Pickup		7.4	1988-1988		HB296x.670	D370		
C3500 Pickup		7.4	1988-2000	Drum	HB296x.670	D370		
C3500 Pickup		7.4	1988-2000	Drum	HB298x.787	D459		
Caballero		3.3	1978-1979		HB119x.594	D154		
Caballero		3.8	1978-1984		HB119x.594	D154		
Caballero		4.3	1985-1987		HB119x.594	D154		
Caballero		4.4	1980-1982		HB119x.594	D154		
Caballero		5.0	1978-1987		HB119x.594	D154		
Caballero		5.7	1978-1979		HB119x.594	D154		
Caballero		5.7	1983-1984		HB119x.594	D154		
Canyon	SL	2.8	2006-2006		HB554x.643	D1039		
Canyon	SL	2.9	2007-2008		HB554x.643	D1039		
Canyon	SLE	2.8	2006-2006		HB554x.643	D1039		
Canyon	SLE	2.9	2007-2008		HB554x.643	D1039		
Canyon	SLE	3.5	2006-2006		HB554x.643	D1039		
Canyon	SLE	3.7	2007-2008		HB554x.643	D1039		
Canyon	SLT	2.9	2008-2008		HB554x.643	D1039		
Canyon	SLT	3.5	2006-2006		HB554x.643	D1039		
Canyon	SLT	3.7	2007-2008		HB554x.643	D1039		
Canyon	WT	2.8	2006-2006		HB554x.643	D1039		
Canyon	WT	2.9	2007-2008		HB554x.643	D1039		
Canyon	WT	3.5	2006-2006		HB554x.643	D1039		
Canyon	WT	3.7	2007-2008		HB554x.643	D1039		
Canyon	Z71 Fleet	2.8	2005-2005		HB554x.643	D1039		
Canyon	Z71 Fleet	3.5	2005-2005		HB554x.643	D1039		
Canyon	Z71 SL	2.8	2005-2005		HB554x.643	D1039		
Canyon	Z71 SL	3.5	2005-2005		HB554x.643	D1039		
Canyon	Z71 SLE	2.8	2005-2005		HB554x.643	D1039		
Canyon	Z71 SLE	3.5	2005-2005		HB554x.643	D1039		
Canyon	Z85 SL	2.8	2005-2005		HB554x.643	D1039		
Canyon	Z85 SL	3.5	2005-2005		HB554x.643	D1039		

RACE COMPOUND CODES

DTC-70 - U | DTC-05 - H | MT-4 - L | DR-97 - J
 DTC-60 - G | HT-14 - V | Blue 9012 - E | HP Plus - N
 DTC-30 - W | HT-10 - S | Black - M

STREET COMPOUND CODES

HPS Performance Street - F | SuperDuty - P
 Performance Ceramic - Z
 LTS Light Truck & SUV - Y

Make/Model	Submodel	Engine		Note	FRONT		REAR	
		(Liter)	Years		Hawk #	FMSI	Hawk #	FMSI
GMC CONT.								
Canyon	Z85 SLE	2.8	2005-2005		HB554x.643	D1039		
Canyon	Z85 SLE	3.5	2005-2005		HB554x.643	D1039		
Canyon		2.8	2004-2004		HB554x.643	D1039		
Canyon		3.5	2004-2004		HB554x.643	D1039		
Envoy	Denali	5.3	2005-2005		HB382x.657	D882	HB383x.685	D883
Envoy	SLE	4.2	2005-2005		HB382x.657	D882	HB383x.685	D883
Envoy	SLT	4.2	2005-2005		HB382x.657	D882	HB383x.685	D883
Envoy	XL	4.2	2002-2004		HB382x.657	D882	HB383x.685	D883
Envoy	XL	5.3	2003-2004		HB382x.657	D882	HB383x.685	D883
Envoy	XL Denali	5.3	2005-2005		HB382x.657	D882	HB383x.685	D883
Envoy	XL SLE	4.2	2005-2005		HB382x.657	D882	HB383x.685	D883
Envoy	XL SLE	5.3	2005-2005		HB382x.657	D882	HB383x.685	D883
Envoy	XL SLT	4.2	2005-2005		HB382x.657	D882		
Envoy	XL SLT	5.3	2005-2005		HB382x.657	D882		
Envoy	XUV	4.2	2004-2004		HB382x.657	D882	HB383x.685	D883
Envoy	XUV	5.3	2004-2004		HB382x.657	D882	HB383x.685	D883
Envoy	XUV SLE	4.2	2005-2005		HB382x.657	D882	HB383x.685	D883
Envoy	XUV SLE	5.3	2005-2005		HB382x.657	D882	HB383x.685	D883
Envoy	XUV SLT	4.2	2005-2005		HB382x.657	D882	HB383x.685	D883
Envoy	XUV SLT	5.3	2005-2005		HB382x.657	D882	HB383x.685	D883
Envoy		4.2	2002-2004		HB382x.657	D882	HB383x.685	D883
G15/G1500 Van	Rally	4.1	1971-1975		HB103x.590	D313		
G15/G1500 Van	Rally	4.1	1977-1984		HB103x.590	D313		
G15/G1500 Van	Rally	4.3	1985-1993		HB103x.590	D313		
G15/G1500 Van	Rally	5.0	1972-1973		HB103x.590	D313		
G15/G1500 Van	Rally	5.0	1977-1993		HB103x.590	D313		
G15/G1500 Van	Rally	5.7	1972-1993		HB103x.590	D313		
G15/G1500 Van	Rally	6.6	1979-1979		HB103x.590	D313		
G15/G1500 Van	Rally	7.4	1979-1979		HB103x.590	D313		
G15/G1500 Van	Vandura	4.1	1970-1984		HB103x.590	D313		
G15/G1500 Van	Vandura	4.3	1985-1995		HB103x.590	D313		
G15/G1500 Van	Vandura	5.0	1972-1973		HB103x.590	D313		
G15/G1500 Van	Vandura	5.0	1977-1995		HB103x.590	D313		
G15/G1500 Van	Vandura	5.7	1972-1981		HB103x.590	D313		
G15/G1500 Van	Vandura	6.6	1976-1976		HB103x.590	D313		
G15/G1500 Van		4.1	1983-1983		HB103x.590	D313		
G15/G1500 Van		5.0	1970-1971		HB103x.590	D313		
G15/G1500 Van		5.0	1983-1983		HB103x.590	D313		
G15/G1500 Van		5.0	1994-1995		HB103x.590	D313		
G15/G1500 Van		5.7	1971-1971		HB103x.590	D313		
G25/G2500 Van	Rally	4.1	1971-1974		HB103x.590	D313		
G25/G2500 Van	Rally	4.1	1979-1984		HB103x.590	D313		
G25/G2500 Van	Rally	4.3	1985-1995		HB103x.590	D313		
G25/G2500 Van	Rally	4.8	1974-1978		HB103x.590	D313		
G25/G2500 Van	Rally	5.0	1973-1973		HB103x.590	D313		
G25/G2500 Van	Rally	5.0	1977-1995		HB103x.590	D313		
G25/G2500 Van	Rally	5.7	1971-1995		HB103x.590	D313		
G25/G2500 Van	Rally	6.2	1983-1993		HB103x.590	D313		
G25/G2500 Van	Rally	6.5	1994-1995		HB103x.590	D313		
G25/G2500 Van	Rally	6.6	1975-1980		HB103x.590	D313		
G25/G2500 Van	Rally	7.4	1975-1976		HB103x.590	D313		
G25/G2500 Van	Vandura	4.1	1970-1974		HB103x.590	D313		
G25/G2500 Van	Vandura	4.1	1978-1984		HB103x.590	D313		

CODE Breakdown

HB 245 x .631

Insert Compound Code

Make/Model	Submodel	Engine (Liter)	Years	Note	FRONT		REAR	
					Hawk #	FMSI	Hawk #	FMSI
GMC CONT.								
G25/G2500 Van	Vandura	4.3	1985-1995		HB103x.590	D313		
G25/G2500 Van	Vandura	4.8	1974-1978		HB103x.590	D313		
G25/G2500 Van	Vandura	5.0	1973-1973		HB103x.590	D313		
G25/G2500 Van	Vandura	5.0	1977-1979		HB103x.590	D313		
G25/G2500 Van	Vandura	5.0	1981-1995		HB103x.590	D313		
G25/G2500 Van	Vandura	5.7	1970-1981		HB103x.590	D313		
G25/G2500 Van	Vandura	5.7	1983-1983		HB103x.590	D313		
G25/G2500 Van	Vandura	5.7	1985-1995		HB103x.590	D313		
G25/G2500 Van	Vandura	6.2	1983-1993		HB103x.590	D313		
G25/G2500 Van	Vandura	6.5	1994-1995		HB103x.590	D313		
G25/G2500 Van	Vandura	6.6	1975-1980		HB103x.590	D313		
G25/G2500 Van		5.0	1970-1972		HB103x.590	D313		
G25/G2500 Van		5.7	1971-1971		HB103x.590	D313		
G35/G3500 Van	Rally	4.1	1971-1974		HB103x.590	D313		
G35/G3500 Van	Rally	4.8	1976-1978		HB103x.590	D313		
G35/G3500 Van	Rally	5.7	1971-1978		HB103x.590	D313		
G35/G3500 Van	Rally	5.7	1979-1984	w/11 in. Drums	HB103x.590	D313		
G35/G3500 Van	Rally	5.7	1979-1984	w/13 in. Drums	HB131x.595	D614		
G35/G3500 Van	Rally	5.7	1985-1995		HB131x.595	D614		
G35/G3500 Van	Rally	6.2	1983-1984	w/11 in. Drums	HB103x.590	D313		
G35/G3500 Van	Rally	6.2	1983-1984	w/13 in. Drums	HB131x.595	D614		
G35/G3500 Van	Rally	6.2	1985-1993		HB131x.595	D614		
G35/G3500 Van	Rally	6.5	1994-1995		HB131x.595	D614		
G35/G3500 Van	Rally	6.6	1975-1978		HB103x.590	D313		
G35/G3500 Van	Rally	6.6	1979-1980	w/11 in. Drums	HB103x.590	D313		
G35/G3500 Van	Rally	6.6	1979-1980	w/13 in. Drums	HB131x.595	D614		
G35/G3500 Van	Rally	7.4	1989-1995		HB131x.595	D614		
G35/G3500 Van	Vandura	4.1	1971-1974		HB103x.590	D313		
G35/G3500 Van	Vandura	4.1	1978-1978		HB103x.590	D313		
G35/G3500 Van	Vandura	4.1	1979-1979	w/11 in. Drums	HB103x.590	D313		
G35/G3500 Van	Vandura	4.1	1979-1979	w/13 in. Drums	HB131x.595	D614		
G35/G3500 Van	Vandura	4.1	1982-1984	w/11 in. Drums	HB103x.590	D313		
G35/G3500 Van	Vandura	4.1	1982-1984	w/13 in. Drums	HB131x.595	D614		
G35/G3500 Van	Vandura	4.3	1985-1989		HB131x.595	D614		
G35/G3500 Van	Vandura	4.3	1990-1990	w/13 x 2.5 in. Drums	HB131x.595	D614		
G35/G3500 Van	Vandura	4.3	1990-1990	w/13 x 3.5 in. Drums	HB337x.791	D149		
G35/G3500 Van	Vandura	4.3	1991-1995		HB131x.595	D614		
G35/G3500 Van	Vandura	4.8	1976-1978		HB103x.590	D313		
G35/G3500 Van	Vandura	5.0	1981-1981	w/11 in. Drums	HB103x.590	D313		
G35/G3500 Van	Vandura	5.0	1981-1981	w/13 in. Drums	HB131x.595	D614		
G35/G3500 Van	Vandura	5.7	1971-1978		HB103x.590	D313		
G35/G3500 Van	Vandura	5.7	1979-1984	w/11 in. Drums	HB103x.590	D313		
G35/G3500 Van	Vandura	5.7	1979-1984	w/13 in. Drums	HB131x.595	D614		
G35/G3500 Van	Vandura	5.7	1985-1989		HB131x.595	D614		
G35/G3500 Van	Vandura	5.7	1990-1990	w/13 x 2.5 in. Drums	HB131x.595	D614		
G35/G3500 Van	Vandura	5.7	1990-1990	w/13 x 3.5 in. Drums	HB337x.791	D149		
G35/G3500 Van	Vandura	5.7	1991-1995		HB131x.595	D614		
G35/G3500 Van	Vandura	6.2	1983-1984	w/11 in. Drums	HB103x.590	D313		
G35/G3500 Van	Vandura	6.2	1983-1984	w/13 in. Drums	HB131x.595	D614		
G35/G3500 Van	Vandura	6.2	1985-1989		HB131x.595	D614		
G35/G3500 Van	Vandura	6.2	1990-1990	w/13 x 2.5 in. Drums	HB131x.595	D614		
G35/G3500 Van	Vandura	6.2	1990-1990	w/13 x 3.5 in. Drums	HB337x.791	D149		
G35/G3500 Van	Vandura	6.2	1991-1993		HB131x.595	D614		

RACE COMPOUND CODES

DTC-70 - U | DTC-05 - H | MT-4 - L | DR-97 - J
 DTC-60 - G | HT-14 - V | Blue 9012 - E | HP Plus - N
 DTC-30 - W | HT-10 - S | Black - M

STREET COMPOUND CODES

HPS Performance Street - F | SuperDuty - P
 Performance Ceramic - Z
 LTS Light Truck & SUV - Y

Make/ Model	Submodel	Engine (Liter)	Years	Note	FRONT		REAR	
					Hawk #	FMSI	Hawk #	FMSI
GMC CONT.								
G35/G3500 Van	Vandura	6.5	1994-1995		HB131x.595	D614		
G35/G3500 Van	Vandura	6.6	1975-1978		HB103x.590	D313		
G35/G3500 Van	Vandura	6.6	1979-1980	w/11 in. Drums	HB103x.590	D313		
G35/G3500 Van	Vandura	6.6	1979-1980	w/13 in. Drums	HB131x.595	D614		
G35/G3500 Van	Vandura	7.4	1989-1989		HB131x.595	D614		
G35/G3500 Van	Vandura	7.4	1990-1990	w/13 x 2.5 in. Drums	HB131x.595	D614		
G35/G3500 Van	Vandura	7.4	1990-1990	w/13 x 3.5 in. Drums	HB337x.791	D149		
G35/G3500 Van	Vandura	7.4	1991-1995		HB131x.595	D614		
G35/G3500 Van		4.8	1974-1975		HB103x.590	D313		
G35/G3500 Van		4.8	1976-1978	w/13 in. Drums	HB103x.590	D313		
G35/G3500 Van		4.8	1976-1978	w/11 in. Drums	HB337x.791	D149		
G35/G3500 Van		5.7	1971-1971		HB103x.590	D313		
G35/G3500 Van		5.7	1974-1975		HB103x.590	D313		
G35/G3500 Van		5.7	1976-1978	w/13 in. Drums	HB103x.590	D313		
G35/G3500 Van		5.7	1976-1978	w/11 in. Drums	HB337x.791	D149		
G35/G3500 Van		5.7	1979-1984	w/11 in. Drums	HB103x.590	D313		
G35/G3500 Van		5.7	1979-1995	w/13 in. Drums	HB131x.595	D614		
G35/G3500 Van		5.7	1979-1995	w/13 in. Drums	HB337x.791	D149		
G35/G3500 Van		6.2	1983-1984	w/11 in. Drums	HB103x.590	D313		
G35/G3500 Van		6.2	1983-1993	w/13 in. Drums	HB131x.595	D614		
G35/G3500 Van		6.2	1983-1993	w/13 in. Drums	HB337x.791	D149		
G35/G3500 Van		6.5	1995-1995	w/13 in. Drums	HB131x.595	D614		
G35/G3500 Van		6.5	1995-1995	w/13 in. Drums	HB337x.791	D149		
G35/G3500 Van		6.6	1976-1978	w/13 in. Drums	HB103x.590	D313		
G35/G3500 Van		6.6	1976-1978	w/11 in. Drums	HB337x.791	D149		
G35/G3500 Van		6.6	1979-1980	w/11 in. Drums	HB103x.590	D313		
G35/G3500 Van		6.6	1979-1980	w/13 in. Drums	HB131x.595	D614		
G35/G3500 Van		6.6	1979-1980	w/13 in. Drums	HB337x.791	D149		
G35/G3500 Van		7.4	1976-1976	w/13 in. Drums	HB103x.590	D313		
G35/G3500 Van		7.4	1976-1976	w/11 in. Drums	HB337x.791	D149		
G35/G3500 Van		7.4	1979-1979	w/11 in. Drums	HB103x.590	D313		
G35/G3500 Van		7.4	1979-1979	w/13 in. Drums	HB131x.595	D614		
G35/G3500 Van		7.4	1979-1979	w/13 in. Drums	HB337x.791	D149		
G35/G3500 Van		7.4	1988-1995	w/13 in. Drums	HB131x.595	D614		
G35/G3500 Van		7.4	1988-1995	w/13 in. Drums	HB337x.791	D149		
G3500 Van	Special	4.3	1996-1996		HB131x.595	D614		
G3500 Van	Special	5.7	1996-1996		HB131x.595	D614		
G3500 Van	Special	6.5	1996-1996		HB131x.595	D614		
G3500 Van	Special	7.4	1996-1996		HB131x.595	D614		
Jimmy	Envoy	4.3	1998-1999		HB119x.594	D154		
Jimmy		4.1	1970-1982		HB103x.590	D313		
Jimmy		4.3	1995-1999		HB119x.594	D154		
Jimmy		4.8	1973-1973		HB103x.590	D313		
Jimmy		5.0	1970-1972		HB103x.590	D313		
Jimmy		5.0	1977-1987		HB103x.590	D313		
Jimmy		5.7	1970-1990		HB103x.590	D313		
Jimmy		5.7	1991-1991		HB119x.594	D154		
Jimmy		6.2	1982-1990		HB103x.590	D313		
Jimmy		6.2	1991-1991		HB119x.594	D154		
Jimmy		6.6	1975-1979		HB103x.590	D313		
Jimmy		7.4	1973-1973		HB103x.590	D313		
Jimmy		7.4	1976-1976		HB103x.590	D313		
K15/K1500 Pickup		4.1	1970-1984		HB103x.590	D313		

CODE Breakdown

HB 245 x .631

Insert Compound Code

Make/Model	Submodel	Engine (Liter)	Years	Note	FRONT		REAR	
					Hawk #	FMSI	Hawk #	FMSI
GMC CONT.								
K15/K1500 Pickup		4.3	1985-1985		HB103x.590	D313		
K15/K1500 Pickup		4.8	1975-1976		HB103x.590	D313		
K15/K1500 Pickup		4.8	1979-1980		HB103x.590	D313		
K15/K1500 Pickup		5.0	1970-1970		HB103x.590	D313		
K15/K1500 Pickup		5.0	1976-1979		HB103x.590	D313		
K15/K1500 Pickup		5.0	1981-1985		HB103x.590	D313		
K15/K1500 Pickup		5.7	1970-1985		HB103x.590	D313		
K15/K1500 Pickup		6.2	1982-1985		HB103x.590	D313		
K15/K1500 Pickup		6.6	1975-1980		HB103x.590	D313		
K15/K1500 Pickup		7.4	1976-1976		HB103x.590	D313		
K15/K1500 Pickup		7.4	1979-1980		HB103x.590	D313		
K15/K1500 Suburban		4.1	1970-1980		HB103x.590	D313		
K15/K1500 Suburban		5.0	1970-1973		HB103x.590	D313		
K15/K1500 Suburban		5.0	1976-1979		HB103x.590	D313		
K15/K1500 Suburban		5.0	1982-1985		HB103x.590	D313		
K15/K1500 Suburban		5.7	1970-1985		HB103x.590	D313		
K15/K1500 Suburban		6.2	1982-1985		HB103x.590	D313		
K15/K1500 Suburban		6.6	1970-1972		HB103x.590	D313		
K15/K1500 Suburban		6.6	1975-1979		HB103x.590	D313		
K1500 Pickup	Sierra	4.3	1989-1991	Extended Cab	HB332x.654	D369		
K1500 Pickup	Sierra	4.3	1989-1991	Regular Cab	HB356x.654	D368		
K1500 Pickup	Sierra	4.3	1992-1998		HB332x.654	D369		
K1500 Pickup	Sierra	5.0	1989-1991	Extended Cab	HB332x.654	D369		
K1500 Pickup	Sierra	5.0	1989-1991	Regular Cab	HB356x.654	D368		
K1500 Pickup	Sierra	5.0	1992-1998		HB332x.654	D369		
K1500 Pickup	Sierra	5.7	1989-1991	Extended Cab	HB332x.654	D369		
K1500 Pickup	Sierra	5.7	1989-1991	Regular Cab	HB356x.654	D368		
K1500 Pickup	Sierra	5.7	1992-1998		HB332x.654	D369		
K1500 Pickup	Sierra	6.2	1989-1991	Extended Cab	HB332x.654	D369		
K1500 Pickup	Sierra	6.2	1989-1991	Regular Cab	HB356x.654	D368		
K1500 Pickup	Sierra	6.2	1992-1993		HB332x.654	D369		
K1500 Pickup	Sierra	6.5	1994-1996		HB332x.654	D369		
K1500 Pickup	Sierra	6.5	1998-1998		HB332x.654	D369		
K1500 Pickup	Sierra XC	4.3	1989-1998		HB332x.654	D369		
K1500 Pickup	Sierra XC	5.0	1989-1998		HB332x.654	D369		
K1500 Pickup	Sierra XC	5.7	1989-1998		HB332x.654	D369		
K1500 Pickup	Sierra XC	6.2	1989-1993		HB332x.654	D369		
K1500 Pickup	Sierra XC	6.5	1994-1998		HB332x.654	D369		
K1500 Pickup		4.3	1988-1988	Extended Cab	HB332x.654	D369		
K1500 Pickup		4.3	1988-1988	Regular Cab	HB356x.654	D368		
K1500 Pickup		5.0	1988-1988	Extended Cab	HB332x.654	D369		
K1500 Pickup		5.0	1988-1988	Regular Cab	HB356x.654	D368		
K1500 Pickup		5.0	1999-1999		HB332x.654	D369		
K1500 Pickup		5.7	1988-1988	Extended Cab	HB332x.654	D369		
K1500 Pickup		5.7	1988-1988	Regular Cab	HB356x.654	D368		
K1500 Pickup		5.7	1999-1999		HB332x.654	D369		
K1500 Pickup		6.2	1988-1988	Extended Cab	HB332x.654	D369		
K1500 Pickup		6.2	1988-1988	Regular Cab	HB356x.654	D368		
K1500 Suburban		5.7	1992-1999		HB332x.654	D369		
K1500 Suburban		5.7	1995-1999		HB296x.670	D370		
K1500 Suburban		6.5	1995-1999		HB296x.670	D370		
K1500 Suburban		6.5	1995-1999		HB332x.654	D369		
K25/K2500 Pickup		4.1	1970-1976		HB103x.590	D313		

RACE COMPOUND CODES

DTC-70 - U	DTC-05 - H	MT-4 - L	DR-97 - J
DTC-60 - G	HT-14 - V	Blue 9012 - E	HP Plus - N
DTC-30 - W	HT-10 - S	Black - M	

STREET COMPOUND CODES

HPS Performance Street - F	SuperDuty - P
Performance Ceramic - Z	
LTS Light Truck & SUV - Y	

Make/Model	Submodel	Engine (Liter)	Years	Note	FRONT		REAR	
					Hawk #	FMSI	Hawk #	FMSI
GMC CONT.								
K25/K2500 Pickup		4.1	1978-1978		HB103x.590	D313		
K25/K2500 Pickup		4.1	1980-1980	w/11 in. Drums	HB103x.590	D313		
K25/K2500 Pickup		4.1	1980-1980	w/13 in. Drums	HB131x.595	D614		
K25/K2500 Pickup		4.3	1985-1985	w/11 in. Drums	HB103x.590	D313		
K25/K2500 Pickup		4.3	1985-1985	w/13 in. Drums	HB131x.595	D614		
K25/K2500 Pickup		4.8	1970-1978		HB103x.590	D313		
K25/K2500 Pickup		4.8	1979-1985	w/11 in. Drums	HB103x.590	D313		
K25/K2500 Pickup		4.8	1979-1986	w/13 in. Drums	HB131x.595	D614		
K25/K2500 Pickup		5.0	1970-1970		HB103x.590	D313		
K25/K2500 Pickup		5.0	1977-1978		HB103x.590	D313		
K25/K2500 Pickup		5.7	1970-1978		HB103x.590	D313		
K25/K2500 Pickup		5.7	1979-1985	w/11 in. Drums	HB103x.590	D313		
K25/K2500 Pickup		5.7	1979-1986	w/13 in. Drums	HB131x.595	D614		
K25/K2500 Pickup		6.2	1982-1985	w/11 in. Drums	HB103x.590	D313		
K25/K2500 Pickup		6.2	1982-1986	w/13 in. Drums	HB131x.595	D614		
K25/K2500 Pickup		6.6	1975-1978		HB103x.590	D313		
K25/K2500 Pickup		6.6	1979-1980	w/11 in. Drums	HB103x.590	D313		
K25/K2500 Pickup		6.6	1979-1980	w/13 in. Drums	HB131x.595	D614		
K25/K2500 Pickup		7.4	1973-1974		HB103x.590	D313		
K25/K2500 Pickup		7.4	1976-1978		HB103x.590	D313		
K25/K2500 Suburban		4.1	1970-1974		HB103x.590	D313		
K25/K2500 Suburban		4.8	1970-1982		HB103x.590	D313		
K25/K2500 Suburban		4.8	1979-1982		HB131x.595	D614		
K25/K2500 Suburban		4.8	1984-1985		HB103x.590	D313		
K25/K2500 Suburban		4.8	1984-1986		HB131x.595	D614		
K25/K2500 Suburban		5.0	1970-1973		HB103x.590	D313		
K25/K2500 Suburban		5.0	1977-1978		HB103x.590	D313		
K25/K2500 Suburban		5.7	1970-1985		HB103x.590	D313		
K25/K2500 Suburban		5.7	1979-1986		HB131x.595	D614		
K25/K2500 Suburban		6.2	1982-1985		HB103x.590	D313		
K25/K2500 Suburban		6.2	1982-1986		HB131x.595	D614		
K25/K2500 Suburban		6.6	1975-1980		HB103x.590	D313		
K25/K2500 Suburban		6.6	1979-1980		HB131x.595	D614		
K25/K2500 Suburban		7.4	1977-1977		HB103x.590	D313		
K2500 Pickup	Sierra	4.3	1989-1995	w/13 in. Drums	HB296x.670	D370		
K2500 Pickup	Sierra	4.3	1989-1995	w/11 in. Drums	HB332x.654	D369		
K2500 Pickup	Sierra	5.0	1989-1995	w/13 in. Drums	HB296x.670	D370		
K2500 Pickup	Sierra	5.0	1989-1995	w/11 in. Drums	HB332x.654	D369		
K2500 Pickup	Sierra	5.7	1989-1997	w/13 in. Drums	HB296x.670	D370		
K2500 Pickup	Sierra	5.7	1989-1997	w/11 in. Drums	HB332x.654	D369		
K2500 Pickup	Sierra	6.2	1989-1993	w/13 in. Drums	HB296x.670	D370		
K2500 Pickup	Sierra	6.2	1989-1993	w/11 in. Drums	HB332x.654	D369		
K2500 Pickup	Sierra	6.5	1992-1997	w/13 in. Drums	HB296x.670	D370		
K2500 Pickup	Sierra	6.5	1992-1997	w/11 in. Drums	HB332x.654	D369		
K2500 Pickup	Sierra	7.4	1991-1997	w/13 in. Drums	HB296x.670	D370		
K2500 Pickup	Sierra	7.4	1991-1997	w/11 in. Drums	HB332x.654	D369		
K2500 Pickup	Sierra XC	4.3	1989-1993	w/13 in. Drums	HB296x.670	D370		
K2500 Pickup	Sierra XC	4.3	1989-1993	w/11 in. Drums	HB332x.654	D369		
K2500 Pickup	Sierra XC	5.0	1989-1995	w/13 in. Drums	HB296x.670	D370		
K2500 Pickup	Sierra XC	5.0	1989-1995	w/11 in. Drums	HB332x.654	D369		
K2500 Pickup	Sierra XC	5.7	1989-1997	w/13 in. Drums	HB296x.670	D370		
K2500 Pickup	Sierra XC	5.7	1989-1997	w/11 in. Drums	HB332x.654	D369		
K2500 Pickup	Sierra XC	6.2	1989-1993	w/13 in. Drums	HB296x.670	D370		

CODE Breakdown

HB 245 x .631

Insert Compound Code

Make/Model	Submodel	Engine (Liter)	Years	Note	FRONT		REAR	
					Hawk #	FMSI	Hawk #	FMSI
GMC CONT.								
K2500 Pickup	Sierra XC	6.2	1989-1993	w/11 in. Drums	HB332x.654	D369		
K2500 Pickup	Sierra XC	6.5	1992-1997	w/13 in. Drums	HB296x.670	D370		
K2500 Pickup	Sierra XC	6.5	1992-1997	w/11 in. Drums	HB332x.654	D369		
K2500 Pickup	Sierra XC	7.4	1991-1997	w/13 in. Drums	HB296x.670	D370		
K2500 Pickup	Sierra XC	7.4	1991-1997	w/11 in. Drums	HB332x.654	D369		
K2500 Pickup		4.3	1988-1988	w/13 in. Drums	HB296x.670	D370		
K2500 Pickup		4.3	1988-1988	w/11 in. Drums	HB332x.654	D369		
K2500 Pickup		5.0	1988-1988	w/13 in. Drums	HB296x.670	D370		
K2500 Pickup		5.0	1988-1988	w/11 in. Drums	HB332x.654	D369		
K2500 Pickup		5.0	1998-1998	w/13 in. Drums	HB296x.670	D370		
K2500 Pickup		5.0	1998-1998	w/11 in. Drums	HB332x.654	D369		
K2500 Pickup		5.7	1988-1988	w/13 in. Drums	HB296x.670	D370		
K2500 Pickup		5.7	1988-1988	w/11 in. Drums	HB332x.654	D369		
K2500 Pickup		5.7	1998-1998	w/13 in. Drums	HB296x.670	D370		
K2500 Pickup		5.7	1998-1998	w/11 in. Drums	HB332x.654	D369		
K2500 Pickup		5.7	1999-2000		HB296x.670	D370		
K2500 Pickup		6.2	1988-1988	w/13 in. Drums	HB296x.670	D370		
K2500 Pickup		6.2	1988-1988	w/11 in. Drums	HB332x.654	D369		
K2500 Pickup		6.5	1998-1998	w/13 in. Drums	HB296x.670	D370		
K2500 Pickup		6.5	1998-1998	w/11 in. Drums	HB332x.654	D369		
K2500 Pickup		6.5	1999-2000		HB296x.670	D370		
K2500 Pickup		7.4	1998-1998	w/13 in. Drums	HB296x.670	D370		
K2500 Pickup		7.4	1998-1998	w/11 in. Drums	HB332x.654	D369		
K2500 Pickup		7.4	1999-2000		HB296x.670	D370		
K2500 Suburban		5.7	1992-1999		HB296x.670	D370		
K2500 Suburban		6.5	1994-1999		HB296x.670	D370		
K2500 Suburban		7.4	1992-1999		HB296x.670	D370		
K35/K3500 Pickup		4.1	1970-1974		HB103x.590	D313		
K35/K3500 Pickup		4.8	1970-1974		HB103x.590	D313		
K35/K3500 Pickup		4.8	1977-1978		HB103x.590	D313		
K35/K3500 Pickup		4.8	1979-1986		HB337x.791	D149		
K35/K3500 Pickup		5.0	1970-1973		HB103x.590	D313		
K35/K3500 Pickup		5.7	1970-1974		HB103x.590	D313		
K35/K3500 Pickup		5.7	1977-1978		HB103x.590	D313		
K35/K3500 Pickup		5.7	1979-1986		HB337x.791	D149		
K35/K3500 Pickup		6.2	1982-1986		HB337x.791	D149		
K35/K3500 Pickup		6.6	1970-1971		HB103x.590	D313		
K35/K3500 Pickup		6.6	1977-1978		HB103x.590	D313		
K35/K3500 Pickup		6.6	1979-1980		HB337x.791	D149		
K35/K3500 Pickup		7.4	1973-1974		HB103x.590	D313		
K35/K3500 Pickup		7.4	1979-1986		HB337x.791	D149		
K3500 Pickup	Sierra	5.7	1989-1989		HB296x.670	D370		
K3500 Pickup	Sierra	5.7	1990-1997	Single Rear Wheels	HB296x.670	D370		
K3500 Pickup	Sierra	5.7	1990-1997	Dual Rear Wheels	HB298x.787	D459		
K3500 Pickup	Sierra	6.2	1989-1989		HB296x.670	D370		
K3500 Pickup	Sierra	6.2	1990-1993	Single Rear Wheels	HB296x.670	D370		
K3500 Pickup	Sierra	6.2	1990-1993	Dual Rear Wheels	HB298x.787	D459		
K3500 Pickup	Sierra	6.5	1992-1997	Single Rear Wheels	HB296x.670	D370		
K3500 Pickup	Sierra	6.5	1992-1997	Dual Rear Wheels	HB298x.787	D459		
K3500 Pickup	Sierra	7.4	1989-1989		HB296x.670	D370		
K3500 Pickup	Sierra	7.4	1990-1997	Single Rear Wheels	HB296x.670	D370		
K3500 Pickup	Sierra	7.4	1990-1997	Dual Rear Wheels	HB298x.787	D459		

RACE COMPOUND CODES

DTC-70 - U | DTC-05 - H | MT-4 - L | DR-97 - J
 DTC-60 - G | HT-14 - V | Blue 9012 - E | HP Plus - N
 DTC-30 - W | HT-10 - S | Black - M

STREET COMPOUND CODES

HPS Performance Street - F | SuperDuty - P
 Performance Ceramic - Z
 LTS Light Truck & SUV - Y

Make/ Model	Submodel	Engine		Note	FRONT		REAR	
		(Liter)	Years		Hawk #	FMSI	Hawk #	FMSI
GMC CONT.								
K3500 Pickup	Sierra XC	5.7	1989-1997		HB296x.670	D370		
K3500 Pickup	Sierra XC	5.7	1990-1997		HB298x.787	D459		
K3500 Pickup	Sierra XC	6.2	1989-1993		HB296x.670	D370		
K3500 Pickup	Sierra XC	6.2	1990-1993		HB298x.787	D459		
K3500 Pickup	Sierra XC	6.5	1993-1997		HB296x.670	D370		
K3500 Pickup	Sierra XC	6.5	1993-1997		HB298x.787	D459		
K3500 Pickup	Sierra XC	7.4	1989-1997		HB296x.670	D370		
K3500 Pickup	Sierra XC	7.4	1990-1997		HB298x.787	D459		
K3500 Pickup		5.7	1988-1988	Single Rear Wheels	HB296x.670	D370		
K3500 Pickup		5.7	1988-2000	Single Rear Wheels	HB296x.670	D370		
K3500 Pickup		5.7	1998-2000	Dual Rear Wheels	HB298x.787	D459		
K3500 Pickup		6.2	1988-1988	Single Rear Wheels	HB296x.670	D370		
K3500 Pickup		6.5	1998-2000	Single Rear Wheels	HB296x.670	D370		
K3500 Pickup		6.5	1998-2000	Dual Rear Wheels	HB298x.787	D459		
K3500 Pickup		7.4	1988-1988	Single Rear Wheels	HB296x.670	D370		
K3500 Pickup		7.4	1998-2000	Single Rear Wheels	HB296x.670	D370		
K3500 Pickup		7.4	1998-2000	Dual Rear Wheels	HB298x.787	D459		
P15/P1500 Van		4.1	1970-1974		HB103x.590	D313		
P15/P1500 Van		4.8	1975-1980		HB103x.590	D313		
P15/P1500 Van		7.4	1979-1979		HB103x.590	D313		
P25/P2500 Van		4.1	1970-1970		HB103x.590	D313		
P25/P2500 Van		4.1	1972-1974		HB103x.590	D313		
P25/P2500 Van		4.8	1970-1978		HB103x.590	D313		
P25/P2500 Van		4.8	1979-1979		HB131x.595	D614		
P25/P2500 Van		4.8	1979-1985	w/11 in. Drums	HB103x.590	D313		
P25/P2500 Van		4.8	1980-1985	w/13 in. Drums	HB131x.595	D614		
P25/P2500 Van		4.8	1986-1987		HB131x.595	D614		
P25/P2500 Van		4.8	1989-1989		HB131x.595	D614		
P25/P2500 Van		5.7	1970-1979		HB103x.590	D313		
P25/P2500 Van		5.7	1979-1979		HB131x.595	D614		
P25/P2500 Van		5.7	1980-1985	w/11 in. Drums	HB103x.590	D313		
P25/P2500 Van		5.7	1980-1985	w/13 in. Drums	HB131x.595	D614		
P25/P2500 Van		5.7	1986-1989		HB131x.595	D614		
P25/P2500 Van		6.2	1982-1985	w/11 in. Drums	HB103x.590	D313		
P25/P2500 Van		6.2	1982-1985	w/13 in. Drums	HB131x.595	D614		
P25/P2500 Van		6.2	1986-1989		HB131x.595	D614		
P25/P2500 Van		7.4	1970-1971		HB103x.590	D313		
P35/P3500 Van	Motor Home	7.4	1974-1974		HB103x.590	D313		
P35/P3500 Van		4.1	1970-1974		HB103x.590	D313		
P35/P3500 Van		4.8	1970-1985		HB103x.590	D313		
P35/P3500 Van		5.7	1970-1985		HB103x.590	D313		
P35/P3500 Van		6.2	1982-1985		HB103x.590	D313		
P35/P3500 Van		7.4	1970-1971		HB103x.590	D313		
P35/P3500 Van		7.4	1973-1985		HB103x.590	D313		
R1500 Suburban		5.7	1990-1991		HB103x.590	D313		
R1500 Suburban		6.2	1990-1991		HB103x.590	D313		
R2500 Pickup		4.3	1987-1987		HB131x.595	D614		
R2500 Pickup		4.8	1987-1988		HB131x.595	D614		
R2500 Pickup		5.0	1987-1987		HB131x.595	D614		
R2500 Pickup		5.7	1987-1989		HB131x.595	D614		
R2500 Pickup		6.2	1987-1989		HB131x.595	D614		
R2500 Pickup		7.4	1987-1989		HB131x.595	D614		
R2500 Suburban		5.7	1987-1989		HB131x.595	D614		

CODE Breakdown

HB 245 x .631

Insert Compound Code

Make/Model	Submodel	Engine (Liter)	Years	Note	FRONT		REAR	
					Hawk #	FMSI	Hawk #	FMSI
GMC CONT.								
R2500 Suburban		6.2	1987-1989		HB131x.595	D614		
R2500 Suburban		7.4	1987-1989		HB131x.595	D614		
R3500 Pickup		4.8	1987-1987		HB337x.791	D149		
R3500 Pickup		4.8	1988-1988	w/13 x 2.5 in. Drums	HB131x.595	D614		
R3500 Pickup		4.8	1988-1988	w/13 x 3.5 in. Drums	HB337x.791	D149		
R3500 Pickup		5.7	1987-1987		HB337x.791	D149		
R3500 Pickup		5.7	1988-1988	w/13 x 2.5 in. Drums	HB131x.595	D614		
R3500 Pickup		5.7	1988-1988	w/13 x 3.5 in. Drums	HB337x.791	D149		
R3500 Pickup		5.7	1989-1990		HB337x.791	D149		
R3500 Pickup		5.7	1991-1991		HB337x.791	D149	HB337x.791	D149
R3500 Pickup		6.2	1987-1987		HB337x.791	D149		
R3500 Pickup		6.2	1988-1988	w/13 x 2.5 in. Drums	HB131x.595	D614		
R3500 Pickup		6.2	1988-1988	w/13 x 3.5 in. Drums	HB337x.791	D149		
R3500 Pickup		6.2	1989-1990		HB337x.791	D149		
R3500 Pickup		6.2	1991-1991		HB337x.791	D149	HB337x.791	D149
R3500 Pickup		7.4	1987-1987		HB337x.791	D149		
R3500 Pickup		7.4	1988-1988	w/13 x 2.5 in. Drums	HB131x.595	D614		
R3500 Pickup		7.4	1988-1988	w/13 x 3.5 in. Drums	HB337x.791	D149		
R3500 Pickup		7.4	1989-1990		HB337x.791	D149		
R3500 Pickup		7.4	1991-1991		HB337x.791	D149	HB337x.791	D149
S15 Jimmy		1.9	1983-1984		HB119x.594	D154		
S15 Jimmy		2.0	1983-1984		HB119x.594	D154		
S15 Jimmy		2.5	1985-1988		HB119x.594	D154		
S15 Jimmy		2.8	1983-1989		HB119x.594	D154		
S15 Jimmy		4.3	1988-1994		HB119x.594	D154		
S15 Pickup		1.9	1983-1985		HB119x.594	D154		
S15 Pickup		2.0	1983-1984		HB119x.594	D154		
S15 Pickup		2.2	1984-1985		HB119x.594	D154		
S15 Pickup		2.5	1985-1990		HB119x.594	D154		
S15 Pickup		2.8	1983-1990		HB119x.594	D154		
S15 Pickup		4.3	1988-1990		HB119x.594	D154		
Safari	XT	4.3	1990-1997		HB332x.654	D369		
Safari	XT	4.3	1991-1992		HB103x.590	D313		
Safari		2.5	1989-1990		HB332x.654	D369		
Safari		4.3	1989-1990		HB332x.654	D369		
Safari		4.3	1991-1992	RWD	HB103x.590	D313		
Safari		4.3	1991-1992	AWD	HB332x.654	D369		
Safari		4.3	1993-1994		HB332x.654	D369		
Safari		4.3	1998-2002		HB332x.654	D369		
Safari		4.3	2003-2005		HB323x.724	D785	HB324x.673	D792
Savana 1500	LS	5.3	2008-2008		HB323x.724	D785	HB494x.670	D974
Savana 1500	LT	5.3	2008-2008		HB323x.724	D785	HB494x.670	D974
Savana 1500		4.3	1999-2002		HB332x.654	D369		
Savana 1500		4.3	2003-2005		HB323x.724	D785	HB494x.670	D974
Savana 1500		4.3	2008-2008		HB323x.724	D785	HB494x.670	D974
Savana 1500		5.0	1999-2002		HB332x.654	D369		
Savana 1500		5.3	2003-2005		HB323x.724	D785	HB494x.670	D974
Savana 1500		5.3	2008-2008		HB323x.724	D785	HB494x.670	D974
Savana 1500		5.7	1999-2002		HB332x.654	D369		
Savana 2500		4.3	1999-2002	8600 lbs. GVWR	HB296x.670	D370		
Savana 2500		4.3	1999-2002	7700 lbs. GVWR	HB332x.654	D369		
Savana 2500		4.3	2003-2005	8600 lbs. GVWR	HB322x.717	D784	HB494x.670	D974

RACE COMPOUND CODES

DTC-70 - U	DTC-05 - H	MT-4 - L	DR-97 - J
DTC-60 - G	HT-14 - V	Blue 9012 - E	HP Plus - N
DTC-30 - W	HT-10 - S	Black - M	

STREET COMPOUND CODES

HPS Performance Street - F	SuperDuty - P
Performance Ceramic - Z	
LTS Light Truck & SUV - Y	

Make/Model	Submodel	Engine (Liter)	Years	Note	FRONT		REAR	
					Hawk #	FMSI	Hawk #	FMSI
GMC CONT.								
Savana 2500		4.3	2003-2005	7200 lbs. GVWR	HB323x.724	D785	HB494x.670	D974
Savana 2500		4.8	2003-2005	8600 lbs. GVWR	HB322x.717	D784	HB494x.670	D974
Savana 2500		4.8	2003-2005	7200 lbs. GVWR	HB323x.724	D785	HB494x.670	D974
Savana 2500		4.8	2006-2008		HB322x.717	D784		
Savana 2500		5.0	1999-2002	8600 lbs. GVWR	HB296x.670	D370		
Savana 2500		5.0	1999-2002	7700 lbs. GVWR	HB332x.654	D369		
Savana 2500		5.3	2003-2005	8600 lbs. GVWR	HB322x.717	D784	HB494x.670	D974
Savana 2500		5.3	2003-2005	7200 lbs. GVWR	HB323x.724	D785	HB494x.670	D974
Savana 2500		5.7	1999-2002	8600 lbs. GVWR	HB296x.670	D370		
Savana 2500		5.7	1999-2002	7700 lbs. GVWR	HB332x.654	D369		
Savana 2500		6.0	2003-2005	8600 lbs. GVWR	HB322x.717	D784	HB494x.670	D974
Savana 2500		6.0	2003-2005	7200 lbs. GVWR	HB323x.724	D785	HB494x.670	D974
Savana 2500		6.0	2006-2008		HB322x.717	D784		
Savana 2500		6.6	2006-2008		HB322x.717	D784		
Savana 3500	LS	6.0	2006-2006		HB322x.717	D784		
Savana 3500	LS	6.0	2008-2008		HB322x.717	D784	HB591x.760	D989
Savana 3500	LT	6.0	2006-2006		HB322x.717	D784		
Savana 3500	LT	6.0	2008-2008		HB322x.717	D784	HB591x.760	D989
Savana 3500		4.8	2004-2008		HB322x.717	D784		
Savana 3500		4.8	2008-2007		HB322x.717	D784	HB591x.760	D989
Savana 3500		5.7	1999-2001	Single Rear Wheels	HB296x.670	D370		
Savana 3500		5.7	1999-2001	Dual Rear Wheels	HB298x.787	D459		
Savana 3500		5.7	2002-2002		HB298x.787	D459		
Savana 3500		6.0	2003-2008		HB322x.717	D784		
Savana 3500		6.0	2008-2007		HB322x.717	D784	HB591x.760	D989
Savana 3500		6.5	1999-2001	Single Rear Wheels	HB296x.670	D370		
Savana 3500		6.5	1999-2001	Dual Rear Wheels	HB298x.787	D459		
Savana 3500		6.5	2002-2002		HB298x.787	D459		
Savana 3500		6.6	2006-2007		HB322x.717	D784		
Savana 3500		6.6	2008-2008		HB322x.717	D784	HB591x.760	D989
Savana 3500		7.4	1999-2000	Single Rear Wheels	HB296x.670	D370		
Savana 3500		7.4	1999-2000	Dual Rear Wheels	HB298x.787	D459		
Savana 3500		8.1	2001-2001	Single Rear Wheels	HB296x.670	D370		
Savana 3500		8.1	2001-2001	Dual Rear Wheels	HB298x.787	D459		
Savana 3500		8.1	2002-2002		HB298x.787	D459		
Sierra 1500	Classic SL	4.3	2007-2007	w/Heavy Duty Brakes	HB322x.717	D784	HB324x.673	D792
Sierra 1500	Classic SL	4.3	2007-2007	w/Standard Brakes	HB561x.710	D1092	HB324x.673	D792
Sierra 1500	Classic SL	4.8	2007-2007	w/Heavy Duty Brakes	HB322x.717	D784	HB324x.673	D792
Sierra 1500	Classic SL	4.8	2007-2007	w/Standard Brakes	HB561x.710	D1092	HB324x.673	D792
Sierra 1500	Classic SL	5.3	2007-2007	w/Heavy Duty Brakes	HB322x.717	D784	HB324x.673	D792
Sierra 1500	Classic SL	5.3	2007-2007	w/Standard Brakes	HB561x.710	D1092	HB324x.673	D792
Sierra 1500	Classic SLE	4.8	2007-2007	Crew Cab, w/Heavy Duty Brakes	HB322x.717	D784	HB324x.673	D792
Sierra 1500	Classic SLE	4.8	2007-2007	Crew Cab, w/Standard Brakes	HB561x.710	D1092	HB324x.673	D792
Sierra 1500	Classic SLE	5.3	2007-2007	Crew Cab, w/Heavy Duty Brakes	HB322x.717	D784	HB324x.673	D792
Sierra 1500	Classic SLE	5.3	2007-2007	Crew Cab, w/Standard Brakes	HB561x.710	D1092	HB324x.673	D792
Sierra 1500	Classic SLE	6.0	2007-2007	Crew Cab, w/Heavy Duty Brakes	HB322x.717	D784	HB324x.673	D792
Sierra 1500	Classic SLE	6.0	2007-2007	Crew Cab, w/Standard Brakes	HB561x.710	D1092	HB324x.673	D792
Sierra 1500	Classic SLT	5.3	2007-2007	Crew Cab, w/Heavy Duty Brakes	HB322x.717	D784	HB324x.673	D792
Sierra 1500	Classic SLT	5.3	2007-2007	Crew Cab, w/Standard Brakes	HB561x.710	D1092	HB324x.673	D792
Sierra 1500	Classic SLT	6.0	2007-2007	Crew Cab, w/Heavy Duty Brakes	HB322x.717	D784	HB324x.673	D792
Sierra 1500	Classic SLT	6.0	2007-2007	Crew Cab, w/Standard Brakes	HB561x.710	D1092	HB324x.673	D792
Sierra 1500	Classic WT	4.3	2007-2007	w/Heavy Duty Brakes	HB322x.717	D784	HB324x.673	D792

CODE Breakdown

HB 245 x .631

Insert Compound Code

Make/Model	Submodel	Engine (Liter)	Years	Note	FRONT		REAR	
					Hawk #	FMSI	Hawk #	FMSI
GMC CONT.								
Sierra 1500	Classic WT	4.3	2007-2007	w/Standard Brakes	HB561x.710	D1092	HB324x.673	D792
Sierra 1500	Classic WT	4.8	2007-2007	w/Heavy Duty Brakes	HB322x.717	D784	HB324x.673	D792
Sierra 1500	Classic WT	4.8	2007-2007	w/Standard Brakes	HB561x.710	D1092	HB324x.673	D792
Sierra 1500	Classic WT	5.3	2007-2007	w/Heavy Duty Brakes	HB322x.717	D784	HB324x.673	D792
Sierra 1500	Classic WT	5.3	2007-2007	w/Standard Brakes	HB561x.710	D1092	HB324x.673	D792
Sierra 1500	SL	4.3	2006-2006		HB561x.710	D1092		
Sierra 1500	SL	4.3	2006-2006		HB561x.710	D1092	HB324x.673	D792
Sierra 1500	SL	4.8	2006-2006		HB561x.710	D1092		
Sierra 1500	SL	4.8	2006-2006		HB561x.710	D1092	HB324x.673	D792
Sierra 1500	SL	4.8	2008-2008		HB561x.710	D1092	HB568x.666	D1194
Sierra 1500	SL	5.3	2006-2006		HB561x.710	D1092		
Sierra 1500	SL	5.3	2006-2006		HB561x.710	D1092	HB324x.673	D792
Sierra 1500	SLE	4.8	2006-2007		HB561x.710	D1092	HB324x.673	D792
Sierra 1500	SLE	4.8	2007-2007		HB322x.717	D784	HB324x.673	D792
Sierra 1500	SLE	4.8	2008-2008		HB561x.710	D1092	HB568x.666	D1194
Sierra 1500	SLE	5.3	2006-2007		HB561x.710	D1092	HB324x.673	D792
Sierra 1500	SLE	5.3	2007-2007		HB322x.717	D784	HB324x.673	D792
Sierra 1500	SLE	5.3	2008-2008		HB561x.710	D1092	HB568x.666	D1194
Sierra 1500	SLE	6.0	2006-2007		HB322x.717	D784	HB324x.673	D792
Sierra 1500	SLE	6.0	2008-2008		HB561x.710	D1092	HB568x.666	D1194
Sierra 1500	SLT	5.3	2006-2007		HB561x.710	D1092	HB324x.673	D792
Sierra 1500	SLT	5.3	2007-2007		HB322x.717	D784	HB324x.673	D792
Sierra 1500	SLT	5.3	2008-2008		HB561x.710	D1092	HB568x.666	D1194
Sierra 1500	SLT	6.0	2006-2007		HB322x.717	D784	HB324x.673	D792
Sierra 1500	SLT	6.0	2008-2008		HB561x.710	D1092	HB568x.666	D1194
Sierra 1500	WT	4.3	2006-2007		HB561x.710	D1092	HB324x.673	D792
Sierra 1500	WT	4.3	2007-2007		HB322x.717	D784	HB324x.673	D792
Sierra 1500	WT	4.3	2008-2008		HB561x.710	D1092	HB568x.666	D1194
Sierra 1500	WT	4.8	2006-2006		HB561x.710	D1092	HB324x.673	D792
Sierra 1500	WT	4.8	2007-2007		HB322x.717	D784	HB324x.673	D792
Sierra 1500	WT	4.8	2008-2008		HB561x.710	D1092	HB568x.666	D1194
Sierra 1500	WT	5.3	2006-2006		HB561x.710	D1092	HB324x.673	D792
Sierra 1500	WT	5.3	2007-2007		HB322x.717	D784	HB324x.673	D792
Sierra 1500	WT	5.3	2008-2008		HB561x.710	D1092	HB568x.666	D1194
Sierra 1500		4.3	1999-2002		HB323x.724	D785	HB324x.673	D792
Sierra 1500		4.3	2003-2003	w/o 4WS	HB323x.724	D785	HB324x.673	D792
Sierra 1500		4.3	2003-2003	w/ 4WS	HB323x.724	D785	HB385x.640	D834
Sierra 1500		4.3	2004-2004	w/o 4WS	HB323x.724	D785	HB494x.670	D974
Sierra 1500		4.3	2005-2005	7200 lbs. GVWR, Crew Cab, Rear Disc w/Hyd. Pwr. Brakes	HB561x.710	D1092	HB323x.724	D785
Sierra 1500		4.3	2005-2005	6400 lbs. GVWR, Rear Disc w/Hyd. Pwr. Brakes	HB561x.710	D1092	HB324x.673	D792
Sierra 1500		4.3	2005-2005	7200 lbs. GVWR, Ext. Cab, w/Hyd. Pwr. Brakes	HB561x.710	D1092	HB385x.640	D834
Sierra 1500		4.3	2005-2005	7200 lbs. GVWR, Crew Cab, Rear Disc w/Vacuum Pwr. Brakes	HB323x.724	D785	HB323x.724	D785
Sierra 1500		4.3	2005-2005	6400 lbs. GVWR, Rear Disc w/Vacuum Pwr. Brakes	HB323x.724	D785	HB324x.673	D792
Sierra 1500		4.3	2005-2005	7200 lbs. GVWR, Ext. Cab, w/Vacuum Pwr. Brakes	HB323x.724	D785	HB385x.640	D834
Sierra 1500		4.8	1999-2002		HB323x.724	D785	HB324x.673	D792
Sierra 1500		4.8	2003-2003	w/o 4WS	HB323x.724	D785	HB324x.673	D792
Sierra 1500		4.8	2003-2003	w/ 4WS	HB323x.724	D785	HB385x.640	D834
Sierra 1500		4.8	2004-2004	w/o 4WS	HB323x.724	D785	HB494x.670	D974
Sierra 1500		4.8	2005-2005	7200 lbs. GVWR, Crew Cab, Rear Disc w/Hyd. Pwr. Brakes	HB561x.710	D1092	HB323x.724	D785
Sierra 1500		4.8	2005-2005	6400 lbs. GVWR, Rear Disc w/Hyd. Pwr. Brakes	HB561x.710	D1092	HB324x.673	D792
Sierra 1500		4.8	2005-2005	7200 lbs. GVWR, Ext. Cab, w/Hyd. Pwr. Brakes	HB561x.710	D1092	HB385x.640	D834
Sierra 1500		4.8	2005-2005	7200 lbs. GVWR, Crew Cab, Rear Disc w/Vacuum Pwr. Brakes	HB323x.724	D785	HB323x.724	D785

RACE COMPOUND CODES

DTC-70 - U | DTC-05 - H | MT-4 - L | DR-97 - J
 DTC-60 - G | HT-14 - V | Blue 9012 - E | HP Plus - N
 DTC-30 - W | HT-10 - S | Black - M

STREET COMPOUND CODES

HPS Performance Street - F | SuperDuty - P
 Performance Ceramic - Z
 LTS Light Truck & SUV - Y

Make/Model	Submodel	Engine		Note	FRONT		REAR	
		(Liter)	Years		Hawk #	FMSI	Hawk #	FMSI
GMC CONT.								
Sierra 1500		4.8	2005-2005	6400 lbs. GVWR, Rear Disc w/Vacuum Pwr. Brakes	HB323x.724	D785	HB324x.673	D792
Sierra 1500		4.8	2005-2005	7200 lbs. GVWR, Ext. Cab, w/Vacuum Pwr. Brakes	HB323x.724	D785	HB385x.640	D834
Sierra 1500		5.3	1999-2002		HB323x.724	D785	HB324x.673	D792
Sierra 1500		5.3	2003-2003	w/o 4WS	HB323x.724	D785	HB324x.673	D792
Sierra 1500		5.3	2003-2003	w/ 4WS	HB323x.724	D785	HB385x.640	D834
Sierra 1500		5.3	2004-2004	w/o 4WS	HB323x.724	D785	HB494x.670	D974
Sierra 1500		5.3	2005-2005	7200 lbs. GVWR, Crew Cab, Rear Disc w/Hyd. Pwr. Brakes	HB561x.710	D1092	HB323x.724	D785
Sierra 1500		5.3	2005-2005	6400 lbs. GVWR, Rear Disc w/Hyd. Pwr. Brakes	HB561x.710	D1092	HB324x.673	D792
Sierra 1500		5.3	2005-2005	7200 lbs. GVWR, Ext. Cab, w/Hyd. Pwr. Brakes	HB561x.710	D1092	HB385x.640	D834
Sierra 1500		5.3	2005-2005	7200 lbs. GVWR, Crew Cab, Rear Disc w/Vacuum Pwr. Brakes	HB323x.724	D785	HB323x.724	D785
Sierra 1500		5.3	2005-2005	6400 lbs. GVWR, Rear Disc w/Vacuum Pwr. Brakes	HB323x.724	D785	HB324x.673	D792
Sierra 1500		5.3	2005-2005	7200 lbs. GVWR, Ext. Cab, w/Vacuum Pwr. Brakes	HB323x.724	D785	HB385x.640	D834
Sierra 1500 HD	SLE	6.0	2005-2006		HB322x.717	D784	HB323x.724	D785
Sierra 1500 HD	SLT	6.0	2005-2005		HB322x.717	D784	HB323x.724	D785
Sierra 1500 HD	SLT	6.0	2006-2006		HB322x.717	D784		
Sierra 1500 HD		6.0	2001-2003		HB322x.717	D784	HB323x.724	D785
Sierra 2500		5.3	2000-2000		HB322x.717	D784	HB323x.724	D785
Sierra 2500		6.0	2000-2004		HB322x.717	D784	HB323x.724	D785
Sierra 2500 HD	SL	6.0	2006-2006		HB322x.717	D784		
Sierra 2500 HD	SL	6.6	2006-2006		HB322x.717	D784		
Sierra 2500 HD	SL	8.1	2006-2006		HB322x.717	D784		
Sierra 2500 HD	SLE	6.0	2006-2006		HB322x.717	D784		
Sierra 2500 HD	SLE	6.0	2008-2008		HB322x.717	D784		
Sierra 2500 HD	SLE	6.6	2006-2006		HB322x.717	D784		
Sierra 2500 HD	SLE	6.6	2008-2008		HB322x.717	D784		
Sierra 2500 HD	SLE	8.1	2006-2006		HB322x.717	D784		
Sierra 2500 HD	SLT	6.0	2006-2006		HB322x.717	D784		
Sierra 2500 HD	SLT	6.0	2008-2008		HB322x.717	D784		
Sierra 2500 HD	SLT	6.6	2006-2006		HB322x.717	D784		
Sierra 2500 HD	SLT	6.6	2008-2008		HB322x.717	D784		
Sierra 2500 HD	SLT	8.1	2006-2006		HB322x.717	D784		
Sierra 2500 HD	WT	6.0	2006-2006		HB322x.717	D784		
Sierra 2500 HD	WT	6.0	2008-2008		HB322x.717	D784		
Sierra 2500 HD	WT	6.6	2006-2006		HB322x.717	D784		
Sierra 2500 HD	WT	6.6	2008-2008		HB322x.717	D784		
Sierra 2500 HD		8.1	2006-2006		HB322x.717	D784		
Sierra 2500 HD		6.0	2001-2001		HB322x.717	D784	HB323x.724	D785
Sierra 2500 HD		6.0	2002-2002		HB323x.724	D785	HB323x.724	D785
Sierra 2500 HD		6.0	2003-2005		HB322x.717	D784	HB323x.724	D785
Sierra 2500 HD		6.6	2001-2001		HB322x.717	D784	HB323x.724	D785
Sierra 2500 HD		6.6	2003-2005		HB322x.717	D784	HB323x.724	D785
Sierra 2500 HD		8.1	2001-2001		HB322x.717	D784	HB323x.724	D785
Sierra 2500 HD		8.1	2003-2005		HB322x.717	D784	HB323x.724	D785
Sierra 3500	SL	6.0	2006-2006		HB322x.717	D784	HB323x.724	D785
Sierra 3500	SL	6.6	2006-2006		HB322x.717	D784	HB323x.724	D785
Sierra 3500	SL	8.1	2006-2006		HB322x.717	D784	HB323x.724	D785
Sierra 3500	SLE	6.0	2006-2006		HB322x.717	D784	HB323x.724	D785
Sierra 3500	SLE	6.0	2008-2008		HB322x.717	D784	HB323x.724	D785
Sierra 3500	SLE	6.6	2006-2006		HB322x.717	D784	HB323x.724	D785
Sierra 3500	SLE	6.6	2008-2008		HB322x.717	D784	HB323x.724	D785
Sierra 3500	SLE	8.1	2006-2006		HB322x.717	D784	HB323x.724	D785
Sierra 3500	SLT	6.0	2006-2006		HB322x.717	D784	HB323x.724	D785

CODE Breakdown

HB 245 x .631

Insert Compound Code

Make/Model	Submodel	Engine (Liter)	Years	Note	FRONT		REAR	
					Hawk #	FMSI	Hawk #	FMSI
GMC CONT.								
Sierra 3500	SLT	6.0	2008-2008		HB322x.717	D784	HB323x.724	D785
Sierra 3500	SLT	6.6	2006-2006		HB322x.717	D784	HB323x.724	D785
Sierra 3500	SLT	6.6	2008-2008		HB322x.717	D784	HB323x.724	D785
Sierra 3500	SLT	8.1	2006-2006		HB322x.717	D784	HB323x.724	D785
Sierra 3500	WT	6.0	2006-2006		HB322x.717	D784	HB323x.724	D785
Sierra 3500	WT	6.0	2008-2008		HB322x.717	D784	HB323x.724	D785
Sierra 3500	WT	6.6	2006-2006		HB322x.717	D784	HB323x.724	D785
Sierra 3500	WT	6.6	2008-2008		HB322x.717	D784	HB323x.724	D785
Sierra 3500	WT	8.1	2006-2006		HB322x.717	D784	HB323x.724	D785
Sierra 3500		6.0	2001-2002		HB322x.717	D784	HB252x.860	D380
Sierra 3500		6.0	2004-2005		HB322x.717	D784	HB323x.724	D785
Sierra 3500		6.6	2001-2002		HB322x.717	D784	HB252x.860	D380
Sierra 3500		6.6	2004-2005		HB322x.717	D784	HB323x.724	D785
Sierra 3500		8.1	2001-2002		HB322x.717	D784	HB252x.860	D380
Sierra 3500		8.1	2004-2005		HB322x.717	D784	HB323x.724	D785
Sierra C3		6.0	2001-2001		HB323x.724	D785		
Sierra Denali	Classic	6.0	2007-2007		HB561x.710	D1092		
Sierra Denali		6.0	2002-2002		HB323x.724	D785	HB323x.724	D785
Sierra Denali		6.0	2004-2005		HB323x.724	D785	HB323x.724	D785
Sierra Denali		6.0	2006-2006		HB323x.724	D785	HB496x.640	D975
Sierra Denali		6.2	2007-2007		HB561x.710	D1092	HB496x.640	D975
Sierra Denali		6.2	2007-2008		HB561x.710	D1092		
Sierra Denali		6.2	2008-2008		HB561x.710	D1092	HB568x.666	D1194
Sonoma		2.2	1994-1996		HB119x.594	D154		
Sonoma		2.5	1991-1993		HB119x.594	D154		
Sonoma		2.8	1991-1993		HB119x.594	D154		
Sonoma		4.3	1991-1996		HB119x.594	D154		
Sprint	Custom	4.1	1972-1972		HB103x.590	D313		
Sprint	Custom	4.1	1975-1977		HB103x.590	D313		
Sprint	Custom	5.0	1976-1977		HB103x.590	D313		
Sprint	Custom	5.7	1972-1977		HB103x.590	D313		
Sprint	Custom	6.6	1974-1976		HB103x.590	D313		
Sprint	Custom	7.4	1972-1975		HB103x.590	D313		
Sprint		4.1	1971-1972		HB103x.590	D313		
Sprint		4.1	1975-1977		HB103x.590	D313		
Sprint		5.0	1971-1973		HB103x.590	D313		
Sprint		5.0	1976-1977		HB103x.590	D313		
Sprint		5.7	1971-1977		HB103x.590	D313		
Sprint		6.6	1971-1972		HB103x.590	D313		
Sprint		6.6	1974-1976		HB103x.590	D313		
Sprint		7.4	1971-1971		HB103x.590	D313		
Sprint		7.4	1973-1974		HB103x.590	D313		
Syclone		4.3	1991-1991		HB119x.594	D154		
Topkick	C4500	6.0	1992-1996		HB251x1.14	D225	HB251x1.14	D225
Topkick	C4500	7.0	1992-1996		HB251x1.14	D225	HB251x1.14	D225
Topkick	C5500	6.0	1992-1996		HB251x1.14	D225	HB251x1.14	D225
Topkick	C5500	7.0	1992-1996		HB251x1.14	D225	HB251x1.14	D225
V1500 Suburban		5.7	1990-1991		HB131x.595	D614		
V1500 Suburban		6.2	1990-1991		HB131x.595	D614		
V2500 Pickup		4.8	1987-1987		HB131x.595	D614		
V2500 Pickup		5.7	1987-1987		HB131x.595	D614		
V2500 Pickup		6.2	1987-1987		HB131x.595	D614		

RACE COMPOUND CODES

DTC-70 - U | DTC-05 - H | MT-4 - L | DR-97 - J
 DTC-60 - G | HT-14 - V | Blue 9012 - E | HP Plus - N
 DTC-30 - W | HT-10 - S | Black - M

STREET COMPOUND CODES

HPS Performance Street - F | SuperDuty - P
 Performance Ceramic - Z
 LTS Light Truck & SUV - Y

Make/Model	Submodel	Engine (Liter)	Years	Note	FRONT		REAR	
					Hawk #	FMSI	Hawk #	FMSI
GMC CONT.								
V2500 Suburban		5.7	1987-1989		HB131x.595	D614		
V2500 Suburban		6.2	1987-1989		HB131x.595	D614		
V3500 Pickup		4.8	1987-1988		HB337x.791	D149		
V3500 Pickup		5.7	1987-1991		HB337x.791	D149		
V3500 Pickup		6.2	1987-1991		HB337x.791	D149		
V3500 Pickup		7.4	1987-1991		HB337x.791	D149		
Yukon	Denali	5.7	2000-2000		HB323x.724	D785		
Yukon	Denali	6.0	2001-2004		HB323x.724	D785	HB385x.640	D834
Yukon	Denali	6.0	2005-2006		HB323x.724	D785	HB496x.640	D975
Yukon	Denali	6.2	2007-2007		HB561x.710	D1092	HB568x.666	D1194
Yukon	Denali XL	6.0	2005-2006		HB323x.724	D785	HB496x.640	D975
Yukon	Hybrid	6.0	2008-2008		HB561x.710	D1092	HB568x.666	D1194
Yukon	SL	4.8	2006-2006	4WD	HB323x.724	D785	HB385x.640	D834
Yukon	SL	4.8	2006-2006	2WD	HB323x.724	D785	HB494x.670	D974
Yukon	SL	5.3	2006-2006	4WD	HB323x.724	D785	HB385x.640	D834
Yukon	SL	5.3	2006-2006	2WD	HB323x.724	D785	HB494x.670	D974
Yukon	SLE	4.8	2005-2005		HB323x.724	D785	HB385x.640	D834
Yukon	SLE	4.8	2006-2006	4WD	HB323x.724	D785	HB385x.640	D834
Yukon	SLE	4.8	2006-2006	2WD	HB323x.724	D785	HB494x.670	D974
Yukon	SLE	4.8	2007-2007		HB561x.710	D1092		
Yukon	SLE	4.8	2008-2008		HB561x.710	D1092	HB568x.666	D1194
Yukon	SLE	5.3	2005-2005		HB323x.724	D785	HB385x.640	D834
Yukon	SLE	5.3	2006-2006	4WD	HB323x.724	D785	HB385x.640	D834
Yukon	SLE	5.3	2006-2006	2WD	HB323x.724	D785	HB494x.670	D974
Yukon	SLE	5.3	2007-2007		HB561x.710	D1092		
Yukon	SLE	5.3	2008-2008		HB561x.710	D1092	HB568x.666	D1194
Yukon	SLT	4.8	2005-2005		HB323x.724	D785	HB385x.640	D834
Yukon	SLT	5.3	2005-2005		HB323x.724	D785	HB385x.640	D834
Yukon	SLT	5.3	2006-2006	4WD	HB323x.724	D785	HB385x.640	D834
Yukon	SLT	5.3	2006-2006	2WD	HB323x.724	D785	HB494x.670	D974
Yukon	SLT	5.3	2007-2008		HB561x.710	D1092	HB568x.666	D1194
Yukon		4.8	2001-2001		HB323x.724	D785	HB385x.640	D834
Yukon		4.8	2002-2002	4WD. w/o Limited Slip	HB323x.724	D785	HB324x.673	D792
Yukon		4.8	2002-2002	2WD. w/Limited Slip	HB323x.724	D785	HB385x.640	D834
Yukon		4.8	2003-2003		HB323x.724	D785	HB385x.640	D834
Yukon		4.8	2004-2004	2WD	HB323x.724	D785	HB494x.670	D974
Yukon		5.3	2001-2001		HB323x.724	D785	HB385x.640	D834
Yukon		5.3	2002-2002	4WD. w/o Limited Slip	HB323x.724	D785	HB324x.673	D792
Yukon		5.3	2002-2002	2WD. w/Limited Slip	HB323x.724	D785	HB385x.640	D834
Yukon		5.3	2003-2003		HB323x.724	D785	HB385x.640	D834
Yukon		5.3	2004-2004	2WD	HB323x.724	D785	HB494x.670	D974
Yukon		5.7	1992-1995		HB322x.717	D784		
Yukon		6.5	1994-1995		HB322x.717	D784		
Yukon XL 1500	Denali	6.2	2007-2007		HB561x.710	D1092	HB568x.666	D1194
Yukon XL 1500	SL	5.3	2006-2006		HB323x.724	D785	HB496x.640	D975
Yukon XL 1500	SLE	5.3	2005-2006		HB323x.724	D785	HB496x.640	D975
Yukon XL 1500	SLE	5.3	2007-2008		HB561x.710	D1092	HB568x.666	D1194
Yukon XL 1500	SLE	6.0	2007-2008		HB561x.710	D1092	HB568x.666	D1194
Yukon XL 1500	SLT	5.3	2005-2006		HB323x.724	D785	HB496x.640	D975
Yukon XL 1500	SLT	5.3	2007-2008		HB561x.710	D1092	HB568x.666	D1194
Yukon XL 1500	SLT	6.0	2007-2008		HB561x.710	D1092	HB568x.666	D1194
Yukon XL 1500		5.3	2000-2002		HB323x.724	D785	HB324x.673	D792

CODE Breakdown

HB 245 x .631

Insert Compound Code

Make/Model	Submodel	Engine (Liter)	Years	Note	FRONT		REAR	
					Hawk #	FMSI	Hawk #	FMSI
GMC CONT.								
Yukon XL 1500		5.3	2003-2003		HB323x.724	D785	HB494x.670	D974
Yukon XL 1500		5.3	2004-2004		HB323x.724	D785	HB385x.640	D834
Yukon XL 2500	SLE	6.0	2005-2008		HB322x.717	D784	HB323x.724	D785
Yukon XL 2500	SLE	8.1	2005-2006		HB322x.717	D784	HB323x.724	D785
Yukon XL 2500	SLT	6.0	2005-2008		HB322x.717	D784	HB323x.724	D785
Yukon XL 2500	SLT	8.1	2005-2006		HB322x.717	D784	HB323x.724	D785
Yukon XL 2500		6.0	2001-2004		HB322x.717	D784	HB323x.724	D785
Yukon XL 2500		8.1	2001-2004		HB322x.717	D784	HB323x.724	D785
HONDA								
Accord	10th Annual	2.2	1993-1993	Sedan (4 Door)	HB275x.620	D465	HB145x.570	D537
Accord	1800 LX	1.8	1984-1985		HB218x.583	D273		
Accord	1800 STD	1.8	1984-1985		HB218x.583	D273		
Accord	25th Edition	2.2	1996-1996	Sedan (4 Door)	HB275x.620	D465		
Accord	DX	2.0	1986-1988		HB403x.587	D334		
Accord	DX	2.2	1991-1994	Coupe (2 Door), Sedan (4 Door)	HB275x.620	D465		
Accord	DX	2.2	1994-1994	Coupe (2 Door), Sedan (4 Door)	HB275x.620	D465	HB145x.570	D537
Accord	DX	2.2	1995-1995	Sedan (4 Door)	HB275x.620	D465	HB145x.570	D537
Accord	DX	2.2	1995-1998	Sedan (4 Door)	HB275x.620	D465		
Accord	DX	2.4	2003-2004		HB447x.667	D959		
Accord	DX	2.4	2005-2005		HB447x.667	D959	HB145x.570	D537
Accord	EX	2.2	1991-1997	Station Wagon	HB143x.680	D503		
Accord	EX	2.2	1995-1998	Coupe (2 Door), Sedan (4 Door)	HB275x.620	D465	HB145x.570	D537
Accord	EX	2.4	2003-2007		HB447x.667	D959	HB145x.570	D537
Accord	EX	2.4	2008-2008		HB366x.681	D787		
Accord	EX	2.7	1995-1997	Station Wagon	HB143x.680	D503		
Accord	EX	2.7	1995-1998	Coupe (2 Door), Sedan (4 Door)	HB275x.620	D465	HB145x.570	D537
Accord	EX	3.0	2003-2007		HB447x.667	D959	HB145x.570	D537
Accord	EX	3.5	2008-2008		HB366x.681	D787		
Accord	Hybrid	3.0	2006-2007		HB447x.667	D959	HB145x.570	D537
Accord	LX	2.0	1986-1988		HB403x.587	D334		
Accord	LX	2.2	1991-1997	Station Wagon	HB143x.680	D503		
Accord	LX	2.2	1991-1993	Coupe (2 Door), Sedan (4 Door)	HB275x.620	D465		
Accord	LX	2.2	1995-1998	Coupe (2 Door), Sedan (4 Door)	HB275x.620	D465	HB145x.570	D537
Accord	LX	2.4	2003-2007		HB447x.667	D959	HB145x.570	D537
Accord	LX	2.4	2008-2008		HB393x.665	D914		
Accord	LX	2.7	1995-1997	Station Wagon	HB143x.680	D503		
Accord	LX	2.7	1995-1998	Coupe (2 Door), Sedan (4 Door)	HB275x.620	D465	HB145x.570	D537
Accord	LX	3.0	2003-2007		HB447x.667	D959	HB145x.570	D537
Accord	LX	3.0	2008-2008		HB393x.665	D914		
Accord	LX Special Edition	2.4	2006-2006		HB447x.667	D959		
Accord	LXi	2.0	1988-1989		HB242x.661	D409		
Accord	S	1.8	1985-1985		HB218x.583	D273		
Accord	SE	2.2	1991-1991	Sedan (4 Door)	HB275x.620	D465	HB145x.570	D537
Accord	SE	2.2	1993-1993	Sedan (4 Door)	HB275x.620	D465	HB145x.570	D537
Accord	SE	2.2	1995-1998	Coupe (2 Door), Sedan (4 Door)	HB275x.620	D465		
Accord	SEi	2.0	1989-1989		HB242x.661	D409	HB350x.496	D374
Accord	Special Edition	2.4	2007-2007		HB447x.667	D959	HB145x.570	D537
Accord	Special Edition	3.0	2007-2007		HB447x.667	D959	HB145x.570	D537
Accord	Value Package	2.2	1995-1998	Sedan (4 Door)	HB275x.620	D465		
Civic	1300	1.3	1987-1987		HB397x.585	D256		
Civic	1500	1.5	1985-1985		HB397x.585	D256		
Civic	1500	1.5	1987-1987		HB397x.585	D256		

RACE COMPOUND CODES

DTC-70 - U	DTC-05 - H	MT-4 - L	DR-97 - J
DTC-60 - G	HT-14 - V	Blue 9012 - E	HP Plus - N
DTC-30 - W	HT-10 - S	Black - M	

STREET COMPOUND CODES

HPS Performance Street - F	SuperDuty - P
Performance Ceramic - Z	
LTS Light Truck & SUV - Y	

Make/Model	Submodel	Engine (Liter)	Years	Note	FRONT		REAR	
					Hawk #	FMSI	Hawk #	FMSI
HONDA CONT.								
Civic	1500 DX	1.5	1984-1987		HB397x.585	D256		
Civic	1500 DX	1.5	1988-1988		HB218x.583	D273		
Civic	1500 GL	1.5	1984-1984		HB397x.585	D256		
Civic	1500 S	1.5	1984-1985		HB397x.585	D256		
Civic	4WD	1.6	1988-1991		HB113x.590	D373		
Civic	CX	1.5	1992-1995		HB218x.583	D273		
Civic	CX	1.6	1996-2000		HB218x.583	D273		
Civic	DX	1.5	1988-1995		HB218x.583	D273		
Civic	DX	1.6	1996-2000		HB218x.583	D273		
Civic	DX	1.7	2001-2005		HB275x.620	D465		
Civic	DX	1.8	2006-2006		HB275x.620	D465	HB145x.570	D537
Civic	DX	1.8	2008-2008		HB275x.620	D465	HB145x.570	D537
Civic	EX	1.6	1990-1990		HB218x.583	D273		
Civic	EX	1.6	1991-1991	Sedan (4 Door)	HB242x.661	D409		
Civic	EX	1.6	1992-1993		HB242x.661	D409	HB350x.496	D374
Civic	EX	1.6	1996-2000		HB275x.620	D465		
Civic	EX	1.7	2001-2005		HB275x.620	D465		
Civic	EX	1.8	2006-2006		HB275x.620	D465	HB145x.570	D537
Civic	EX	1.8	2008-2008		HB275x.620	D465	HB145x.570	D537
Civic	GX	1.6	1998-2000		HB218x.583	D273		
Civic	GX	1.7	2001-2005		HB275x.620	D465		
Civic	GX	1.8	2006-2006		HB275x.620	D465	HB145x.570	D537
Civic	HX	1.6	1996-2000		HB218x.583	D273		
Civic	HX	1.7	2001-2005		HB275x.620	D465		
Civic	Hybrid	1.3	2003-2008		HB418x.646	D621		
Civic	LX	1.5	1988-1993		HB218x.583	D273		
Civic	LX	1.6	1996-2000		HB218x.583	D273		
Civic	LX	1.7	2001-2005		HB275x.620	D465		
Civic	LX	1.8	2006-2006		HB275x.620	D465	HB145x.570	D537
Civic	LX	1.8	2008-2008		HB275x.620	D465	HB145x.570	D537
Civic	Mugen Si	2.0	2008-2008		HB275x.620	D465	HB145x.570	D537
Civic	Si	1.6	1989-1990		HB218x.583	D273		
Civic	Si	1.6	1992-1993		HB218x.583	D273		
Civic	Si	1.6	1999-2000		HB275x.620	D465	HB350x.496	D374
Civic	Si	2.0	2002-2002		HB275x.620	D465	HB350x.496	D374
Civic	Si	2.0	2003-2004	w/Drum Style Parking Brake	HB275x.620	D465	HB145x.570	D537
Civic	Si	2.0	2003-2004	w/Drum Style Parking Brake, w/Integrated Parking Brake	HB275x.620	D465	HB350x.496	D374
Civic	Si	2.0	2004-2004	w/Drum Style Parking Brake, w/Integrated Parking Brake	HB418x.646	D621		
Civic	Si	2.0	2005-2005		HB418x.646	D621	HB145x.570	D537
Civic	Si	2.0	2008-2008		HB275x.620	D465	HB145x.570	D537
Civic	Value Package	1.7	2004-2005		HB275x.620	D465		
Civic	VX	1.5	1992-1995		HB218x.583	D273		
Civic		1.3	1985-1987		HB397x.585	D256		
Civic		1.5	1988-1991		HB218x.583	D273		
Civic Del Sol	S	1.5	1993-1995		HB218x.583	D273		
Civic Del Sol	S	1.6	1996-1997		HB218x.583	D273		
Civic Del Sol	Si	1.6	1993-1997		HB218x.583	D273	HB350x.496	D374
Civic Del Sol	VTEC	1.6	1994-1997		HB218x.583	D273	HB350x.496	D374
CR-V	EX	2.0	1998-2001		HB143x.680	D503		
CR-V	EX	2.4	2005-2006		HB393x.665	D914		
CR-V	LX	2.0	1997-2001		HB143x.680	D503		
CR-V	LX	2.4	2002-2004	w/Drum Style Parking Brake	HB393x.665	D914	HB145x.570	D537

CODE Breakdown

HB 245 x .631

Insert Compound Code

Make/ Model	Submodel	Engine (Liter)	Years	Note	FRONT		REAR	
					Hawk #	FMSI	Hawk #	FMSI
HONDA CONT.								
CR-V	LX	2.4	2002-2004	w/Integrated Parking Brake	HB393x.665	D914	HB572x.570	D536
CR-V	LX	2.4	2005-2006		HB393x.665	D914	HB145x.570	D537
CR-V	SE	2.0	2000-2001		HB143x.680	D503		
CR-V	SE	2.4	2005-2006		HB393x.665	D914	HB145x.570	D537
CRX	1500 HF	1.5	1988-1989		HB397x.585	D256		
CRX	DX	1.5	1988-1990		HB218x.583	D273		
CRX	HF	1.5	1990-1991		HB397x.585	D256		
CRX	Si	1.6	1988-1989		HB218x.583	D273		
Element	EX	2.4	2005-2006	w/Drum Style Parking Brake	HB393x.665	D914	HB145x.570	D537
Element	EX	2.4	2005-2006	w/Integrated Parking Brake	HB393x.665	D914	HB572x.570	D536
Element	EX	2.4	2007-2007		HB393x.665	D914	HB572x.570	D536
Element	EX	2.4	2008-2008	w/Drum Style Parking Brake	HB393x.665	D914	HB145x.570	D537
Element	EX	2.4	2008-2008	w/Integrated Parking Brake	HB393x.665	D914	HB572x.570	D536
Element	LX	2.4	2004-2006	w/Drum Style Parking Brake	HB393x.665	D914	HB145x.570	D537
Element	LX	2.4	2004-2006	w/Integrated Parking Brake	HB393x.665	D914	HB572x.570	D536
Element	LX	2.4	2007-2007		HB393x.665	D914	HB572x.570	D536
Element	LX	2.4	2008-2008	w/Drum Style Parking Brake	HB393x.665	D914	HB145x.570	D537
Element	LX	2.4	2008-2008	w/Integrated Parking Brake	HB393x.665	D914	HB572x.570	D536
Element	SC	2.4	2007-2007		HB393x.665	D914	HB572x.570	D536
Element	SC	2.4	2008-2008	w/Drum Style Parking Brake	HB393x.665	D914	HB145x.570	D537
Element	SC	2.4	2008-2008	w/Integrated Parking Brake	HB393x.665	D914	HB572x.570	D536
Element		2.4	2003-2004	w/Drum Style Parking Brake	HB393x.665	D914	HB145x.570	D537
Element		2.4	2003-2004	w/Integrated Parking Brake	HB393x.665	D914	HB572x.570	D536
Fit	Sport	1.5	2008-2008		HB418x.646	D621		
Fit		1.5	2008-2008		HB418x.646	D621		
Insight	Electric	1.0	2001-2004		HB397x.585	D256		
Insight		1.0	2005-2006		HB397x.585	D256		
Odyssey	Cargo	3.5	1999-2001		HB386x.669	D793		
Odyssey	Cargo	3.5	2002-2002		HB386x.669	D793	HB506x.610	D865
Odyssey	EX	2.2	1995-1997	w/Drum Style Parking Brake	HB143x.680	D503	HB145x.570	D537
Odyssey	EX	2.2	1995-1997	w/Integrated Parking Brake	HB143x.680	D503	HB572x.570	D536
Odyssey	EX	2.3	1998-1998	w/Drum Style Parking Brake	HB143x.680	D503	HB145x.570	D537
Odyssey	EX	2.3	1998-1998	w/Integrated Parking Brake	HB143x.680	D503	HB572x.570	D536
Odyssey	EX	3.5	1999-2003		HB386x.669	D793		
Odyssey	EX	3.5	2002-2004		HB386x.669	D793	HB506x.610	D865
Odyssey	LX	2.2	1995-1997	w/Drum Style Parking Brake	HB143x.680	D503	HB145x.570	D537
Odyssey	LX	2.2	1995-1997	w/Integrated Parking Brake	HB143x.680	D503	HB572x.570	D536
Odyssey	LX	2.3	1998-1998	w/Drum Style Parking Brake	HB143x.680	D503	HB145x.570	D537
Odyssey	LX	2.3	1998-1998	w/Integrated Parking Brake	HB143x.680	D503	HB572x.570	D536
Odyssey	LX	3.5	1999-2003		HB386x.669	D793		
Odyssey	LX	3.5	2002-2004		HB386x.669	D793	HB506x.610	D865
Passport	DX	2.6	1994-1996		HB422x.610	D579		
Passport	EX	3.2	1994-2001		HB422x.610	D579		
Passport	LX	3.2	1994-2001		HB422x.610	D579		
Pilot	EX	3.5	2006-2008		HB393x.665	D914	HB506x.610	D865
Pilot	EX-L	3.5	2008-2008		HB393x.665	D914	HB506x.610	D865
Pilot	LX	3.5	2006-2007		HB393x.665	D914	HB506x.610	D865
Pilot	Special Edition	3.5	2008-2008		HB393x.665	D914	HB506x.610	D865
Pilot	Value Package	3.5	2008-2008		HB393x.665	D914	HB506x.610	D865
Pilot		3.5	2003-2005		HB393x.665	D914	HB506x.610	D865
Prelude	2.0 Si	2.0	1985-1987		HB403x.587	D334	HB350x.496	D374
Prelude	2.0 Si	2.0	1988-1991		HB242x.661	D409	HB350x.496	D374

RACE COMPOUND CODES

DTC-70 - U	DTC-05 - H	MT-4 - L	DR-97 - J
DTC-60 - G	HT-14 - V	Blue 9012 - E	HP Plus - N
DTC-30 - W	HT-10 - S	Black - M	

STREET COMPOUND CODES

HPS Performance Street - F	SuperDuty - P
Performance Ceramic - Z	
LTS Light Truck & SUV - Y	

Make/ Model	Submodel	Engine		Note	FRONT		REAR	
		(Liter)	Years		Hawk #	FMSI	Hawk #	FMSI
HONDA CONT.								
Prelude	2.0 Si 4WS	2.0	1988-1989		HB242x.661	D409	HB350x.496	D374
Prelude	4WS	2.3	1993-1994		HB144x.719	D568	HB145x.570	D537
Prelude	S	2.2	1992-1996		HB144x.719	D568	HB145x.570	D537
Prelude	SE	2.3	1995-1995		HB144x.719	D568	HB145x.570	D537
Prelude	SH	2.2	1997-2001		HB143x.680	D503	HB145x.570	D537
Prelude	Si	2.1	1990-1991		HB242x.661	D409	HB350x.496	D374
Prelude	Si	2.3	1992-1996		HB144x.719	D568	HB145x.570	D537
Prelude	Si 4WS	2.1	1990-1991		HB242x.661	D409	HB350x.496	D374
Prelude	Si 4WS	2.3	1992-1992		HB144x.719	D568	HB145x.570	D537
Prelude	Si ALB	2.1	1990-1991		HB242x.661	D409	HB350x.496	D374
Prelude	VTEC	2.2	1993-1996		HB143x.680	D503	HB145x.570	D537
Prelude		1.8	1983-1984		HB397x.585	D256		
Prelude		1.8	1985-1987		HB397x.585	D256	HB350x.496	D374
Prelude		2.2	1997-2001		HB143x.680	D503	HB145x.570	D537
S2000	CR	2.2	2008-2008		HB361x.622	D829		
S2000		2.0	2000-2003		HB361x.622	D829	HB145x.570	D537
S2000		2.2	2004-2007		HB361x.622	D829	HB145x.570	D537
S2000		2.2	2008-2008		HB361x.622	D829		
Wagovan		1.5	1986-1987		HB397x.585	D256		
HUMMER								
H1	Alpha	6.6	2006-2006		HB264x.575	D1025	HB264x.575	D1025
H2		6.0	2003-2007		HB322x.717	D784	HB323x.724	D785
H2		6.2	2008-2008		HB322x.717	D784	HB323x.724	D785
H3	Alpha	5.3	2008-2008		HB526x.665	D1119	HB527x.604	D1120
H3	X	3.7	2008-2008		HB526x.665	D1119	HB527x.604	D1120
H3		3.5	2006-2006		HB526x.665	D1119	HB527x.604	D1120
H3		3.7	2007-2008		HB526x.665	D1119	HB527x.604	D1120
HYUNDAI								
Elantra	GLS	2.0	2007-2008		HB368x.665	D924		
Elantra	Limited	2.0	2007-2007		HB368x.665	D924		
Elantra	SE	2.0	2007-2008		HB368x.665	D924		
Elantra		1.6	1992-1995		HB261x.665	D700		
Elantra		1.8	1993-1997		HB261x.665	D700		
Elantra		1.8	1998-1998		HB261x.665	D700	HB262x.540	D429
Elantra		2.0	1999-2000		HB261x.665	D700	HB262x.540	D429
Santa Fe	GLS	2.7	2006-2006		HB461x.646	D864		
Santa Fe	GLS	3.5	2006-2006		HB461x.646	D864		
Santa Fe	Limited	3.5	2006-2006		HB461x.646	D864		
Santa Fe		2.4	2001-2004		HB461x.646	D864		
Santa Fe		2.7	2001-2005		HB461x.646	D864		
Santa Fe		3.5	2003-2005		HB461x.646	D864		
Sonata	GL	2.0	1992-1997		HB261x.665	D700		
Sonata	GL	2.4	1989-1991		HB261x.665	D700		
Sonata	GL	2.4	2005-2006		HB368x.665	D924		
Sonata	GL	3.0	1990-1997		HB261x.665	D700		
Sonata	GLS	2.0	1992-1994		HB261x.665	D700		
Sonata	GLS	2.4	1989-1991		HB261x.665	D700		
Sonata	GLS	2.4	2006-2009		HB368x.665	D924		
Sonata	GLS	2.7	2002-2004		HB261x.665	D700		
Sonata	GLS	3.0	1990-1997		HB261x.665	D700		
Sonata	GLS	3.3	2008-2008		HB368x.665	D924		
Sonata	Limited	2.4	2008-2009		HB368x.665	D924		

CODE Breakdown

HB 245 x .631

Insert Compound Code

Make/Model	Submodel	Engine (Liter)	Years	Note	FRONT		REAR	
					Hawk #	FMSI	Hawk #	FMSI
HYUNDAI CONT.								
Sonata	Limited	3.3	2007-2008		HB368x.665	D924		
Sonata	LX	2.7	2005-2005		HB368x.665	D924		
Sonata	LX	3.3	2006-2006		HB368x.665	D924		
Sonata	SE	2.4	2008-2009		HB368x.665	D924		
Sonata	SE	3.3	2007-2008		HB368x.665	D924		
Sonata		2.0	1992-1998		HB261x.665	D700		
Sonata		2.4	1989-1991		HB261x.665	D700		
Sonata		2.4	1999-2001		HB261x.665	D700		
Sonata		2.4	2002-2004		HB368x.665	D924		
Sonata		2.5	1999-2001		HB261x.665	D700		
Sonata		2.7	2002-2004		HB261x.665	D700		
Sonata		3.0	1990-1994		HB261x.665	D700		
Sonata		3.0	1998-1998		HB261x.665	D700		
Tiburon	FX	2.0	1997-1998		HB261x.665	D700	HB262x.540	D429
Tiburon	GS	2.0	2005-2006		HB368x.665	D924	HB262x.540	D429
Tiburon	GS	2.0	2008-2008		HB368x.665	D924	HB262x.540	D429
Tiburon	GT	2.7	2003-2006		HB368x.665	D924	HB262x.540	D429
Tiburon	GT	2.7	2007-2007		HB368x.665	D924		
Tiburon	GT Limited	2.7	2007-2007		HB368x.665	D924		
Tiburon		1.8	1997-1997		HB261x.665	D700		
Tiburon		2.0	1998-1999		HB261x.665	D700		
Tiburon		2.0	2003-2004		HB368x.665	D924	HB262x.540	D429
Tucson	GL	2.0	2005-2006		HB368x.665	D924		
Tucson	GLS	2.0	2008-2008		HB368x.665	D924		
Tucson	GLS	2.7	2005-2006		HB368x.665	D924		
Tucson	Limited	2.0	2008-2008		HB368x.665	D924		
Tucson	Limited	2.7	2006-2006		HB368x.665	D924		
Tucson	Limited	2.7	2008-2008		HB368x.665	D924		
Tucson	LX	2.7	2005-2005		HB368x.665	D924		
Tucson	SE	2.7	2008-2008		HB368x.665	D924		
XG300		3.0	2001-2001		HB461x.646	D864		
XG350	L	3.5	2002-2004		HB461x.646	D864		
XG350		3.5	2002-2005		HB461x.646	D864		
INFINITI								
EX35	Journey	3.5	2008-2008		HB387x.547	D888		
EX35		3.5	2008-2008		HB387x.547	D888		
FX35		3.5	2003-2005		HB448x.610	D969	HB370x.559	D905
FX35		3.5	2006-2006	Made On or After 11-1-05	HB387x.547	D888	HB370x.559	D905
FX35		3.5	2006-2006	Made On or Before 10-31-05	HB448x.610	D969	HB370x.559	D905
FX35		3.5	2007-2008		HB387x.547	D888	HB370x.559	D905
FX45		4.5	2003-2005		HB448x.610	D969	HB370x.559	D905
FX45		4.5	2006-2006	Made On or After 11-1-05	HB387x.547	D888	HB370x.559	D905
FX45		4.5	2006-2006	Made On or Before 10-31-05	HB448x.610	D969	HB370x.559	D905
FX45		4.5	2007-2008		HB387x.547	D888	HB370x.559	D905
G20		2.0	1991-1996		HB235x.665	D462	HB421x.622	D540
G20		2.0	1999-2000		HB268x.665	D653	HB421x.622	D540
G20		2.0	2001-2001	Made On or After 12-1-01	HB268x.665	D653	HB378x.565	D1008
G20		2.0	2001-2001	Made On or After 12-1-01	HB268x.665	D653	HB378x.626	D1008
G20		2.0	2001-2001	Made On or Before 11-30-01	HB268x.665	D653	HB421x.622	D540
G35		3.5	2003-2004	w/o Brembo Brakes	HB268x.665	D815	HB370x.559	D905
G35		3.5	2003-2004	w/Brembo Brakes	HB545x.564	D960	HB180x.560	D961
G35		3.5	2005-2006	AWD	HB268x.665	D815	HB370x.559	D905

RACE COMPOUND CODES

DTC-70 - U	DTC-05 - H	MT-4 - L	DR-97 - J
DTC-60 - G	HT-14 - V	Blue 9012 - E	HP Plus - N
DTC-30 - W	HT-10 - S	Black - M	

STREET COMPOUND CODES

HPS Performance Street - F	SuperDuty - P
Performance Ceramic - Z	
LTS Light Truck & SUV - Y	

Make/Model	Submodel	Engine		Note	FRONT		REAR	
		(Liter)	Years		Hawk #	FMSI	Hawk #	FMSI
INFINITI CONT.								
G35		3.5	2005-2006	RWD	HB387x.547	D888	HB370x.559	D905
G35		3.5	2007-2007	Except Sport Models	HB387x.547	D888	HB370x.559	D905
G35		3.5	2007-2008	Sport Models	HB599x.616	D1287	HB600x.539	D1288
G35		3.5	2008-2008	Except Sport Models	HB387x.547	D888	HB600x.539	D1288
G37	Sport	3.7	2008-2008		HB601x.626	D1346	HB602x.545	D1347
G37		3.7	2008-2008		HB599x.616	D1287	HB600x.539	D1288
I30		3.0	1996-1999		HB412x.665	D526		
I30		3.0	2000-2000		HB268x.665	D653	HB421x.622	D540
I30		3.0	2001-2001		HB268x.665	D653		
I35		3.5	2002-2004		HB268x.665	D653		
J30		3.0	1993-1997		HB415x.583	D587	HB437x.585	D588
M30		3.0	1990-1991		HB475x.642	D266		
M35	Sport	3.5	2006-2007		HB387x.547	D888	HB370x.559	D905
M35	X	3.5	2006-2007		HB387x.547	D888	HB370x.559	D905
M35		3.5	2006-2008		HB387x.547	D888	HB370x.559	D905
M45	Sport	4.5	2006-2007		HB387x.547	D888	HB370x.559	D905
M45		4.5	2003-2004		HB387x.547	D888	HB437x.585	D588
M45		4.5	2006-2008		HB387x.547	D888	HB370x.559	D905
Q45		4.1	1997-2001		HB326x.646	D691	HB437x.585	D588
Q45		4.5	1990-1996		HB326x.646	D691	HB437x.585	D588
Q45		4.5	2002-2005		HB387x.547	D888	HB437x.585	D588
Q45		4.5	2006-2006		HB387x.547	D888		
QX4		3.3	1997-2000		HB326x.646	D691		
QX4		3.5	2001-2003		HB326x.646	D691		
QX56		5.6	2004-2006		HB567x.694	D1183	HB555x.678	D1041
INTERNATIONAL								
1600			1984-1989		HB251x1.14	D225	HB251x1.14	D225
1700			1984-1989		HB251x1.14	D225	HB251x1.14	D225
1750			1984-1989		HB251x1.14	D225	HB251x1.14	D225
1800			1984-1989		HB251x1.14	D225	HB251x1.14	D225
1850			1984-1989		HB251x1.14	D225	HB251x1.14	D225
1900			1985-1989		HB251x1.14	D225	HB251x1.14	D225
1950B			1985-1989		HB251x1.14	D225	HB251x1.14	D225
Pickup 100		4.2	1974-1974		HB292x.674	D50		
Pickup 100		5.0	1974-1974		HB292x.674	D50		
Pickup 100		5.6	1974-1974		HB292x.674	D50		
Pickup 100		6.4	1974-1974		HB292x.674	D50		
Pickup 150		5.0	1975-1975		HB292x.674	D50		
Pickup 150		5.6	1975-1975		HB292x.674	D50		
Pickup 150		6.4	1975-1975		HB292x.674	D50		
Scout II	SS2	3.2	1978-1979		HB292x.674	D50		
Scout II	SS2	5.0	1978-1979		HB292x.674	D50		
Scout II	SS2	5.6	1978-1979		HB292x.674	D50		
Scout II	Terra	3.2	1976-1980		HB292x.674	D50		
Scout II	Terra	5.0	1976-1980		HB292x.674	D50		
Scout II	Terra	5.6	1976-1980		HB292x.674	D50		
Scout II	Traveler	3.2	1976-1980		HB292x.674	D50		
Scout II	Traveler	5.0	1976-1980		HB292x.674	D50		
Scout II	Traveler	5.6	1976-1980		HB292x.674	D50		
Scout II		3.2	1974-1980		HB292x.674	D50		
Scout II		5.0	1974-1980		HB292x.674	D50		
Scout II		5.6	1975-1980		HB292x.674	D50		

CODE Breakdown

HB 245 x .631

Insert Compound Code

Make/ Model	Submodel	Engine (Liter)	Years	Note	FRONT		REAR	
					Hawk #	FMSI	Hawk #	FMSI
INTERNATIONAL CONT.								
Scout II		5.7	1974-1974		HB292x.674	D50		
Scout II		6.4	1975-1975		HB292x.674	D50		
ISUZU								
Amigo		2.2	1998-2000		HB422x.610	D579		
Amigo		3.2	1998-2000		HB422x.610	D579		
Ascender	Limited	5.3	2005-2005		HB382x.657	D882	HB383x.685	D883
Ascender	LS	4.2	2005-2006		HB382x.657	D882	HB383x.685	D883
Ascender	LS	5.3	2005-2006		HB382x.657	D882	HB383x.685	D883
Ascender	S	4.2	2005-2005		HB382x.657	D882	HB383x.685	D883
Ascender	S	5.3	2005-2005		HB382x.657	D882	HB383x.685	D883
Ascender		4.2	2003-2004		HB382x.657	D882	HB383x.685	D883
Ascender		4.2	2006-2006		HB382x.657	D882	HB383x.685	D883
Ascender		5.3	2003-2004		HB382x.657	D882	HB383x.685	D883
Axiom		3.5	2002-2004		HB422x.610	D579		
Hombre		2.2	1996-2000	2WD	HB119x.594	D154		
Hombre		2.2	1998-2000	4WD	HB304x.598	D726		
Hombre		4.3	1997-2000	2WD	HB119x.594	D154		
Hombre		4.3	1998-2000	4WD	HB304x.598	D726		
I-280		2.8	2006-2006		HB554x.643	D1039		
I-290	LS	2.9	2007-2007		HB554x.643	D1039		
I-290	S	2.9	2007-2008		HB554x.643	D1039		
I-350		3.5	2006-2006		HB554x.643	D1039		
I-370	LS	3.7	2007-2008		HB554x.643	D1039		
Impulse	RS	1.6	1991-1992		HB148x.560	D525		
Impulse	XS	1.6	1991-1991		HB148x.560	D525		
Impulse	XS	1.8	1992-1992		HB148x.560	D525		
Impulse		1.6	1990-1990		HB148x.560	D525		
Rodeo		2.2	1998-2001		HB422x.610	D579		
Rodeo		2.6	1993-1997		HB422x.610	D579		
Rodeo		3.2	1993-2001		HB422x.610	D579		
Rodeo Sport		2.2	2001-2001		HB422x.610	D579		
Rodeo Sport		3.2	2001-2001		HB422x.610	D579		
Trooper	LS	3.2	1992-1997		HB422x.610	D579		
Trooper	LTD	3.2	1997-1997		HB422x.610	D579		
Trooper	RS	3.2	1993-1995		HB422x.610	D579		
Trooper	S	3.2	1992-1997		HB422x.610	D579		
Trooper	SE	3.2	1996-1996		HB422x.610	D579		
Trooper		3.5	1998-2002		HB422x.610	D579		
Vehicross		3.5	1999-2001		HB422x.610	D579		
JAGUAR								
S-Type		3.0	2000-2004		HB376x.665	D805	HB428x.650	D806
S-Type		4.0	2000-2002		HB376x.665	D805	HB428x.650	D806
S-Type		4.2	2003-2004		HB376x.665	D805	HB428x.650	D806
Vanden Plas		4.0	1990-2003		HB135x.642	D394		
XJ12		6.0	1995-1996		HB135x.642	D394		
XJ6	L	4.0	1997-1997		HB135x.642	D394		
XJ6	Sovereign	4.0	1990-1993		HB135x.642	D394		
XJ6		4.0	1990-1997		HB135x.642	D394		
XJ8		4.0	2000-2003		HB135x.642	D394		
XJR		4.0	1995-1999		HB193x.670	D810	HB193x.670	D810
XJR		4.0	1995-2003		HB135x.642	D394		

RACE COMPOUND CODES

DTC-70 - U	DTC-05 - H	MT-4 - L	DR-97 - J
DTC-60 - G	HT-14 - V	Blue 9012 - E	HP Plus - N
DTC-30 - W	HT-10 - S	Black - M	

STREET COMPOUND CODES

HPS Performance Street - F	SuperDuty - P
Performance Ceramic - Z	
LTS Light Truck & SUV - Y	

Make/Model	Submodel	Engine		Note	FRONT		REAR	
		(Liter)	Years		Hawk #	FMSI	Hawk #	FMSI
JAGUAR CONT.								
XK8	Victory Edition	4.2	2006-2006		HB135x.642	D394		
XK8		4.0	1997-2002		HB135x.642	D394		
XK8		4.2	2003-2006		HB135x.642	D394	HB194x.570	D592
JEEP								
Cherokee	S	4.2	1974-1976		HB103x.590	D313		
Cherokee	S	5.9	1974-1976		HB103x.590	D313		
Cherokee	S	6.6	1974-1976		HB103x.590	D313		
Cherokee (XJ)	Briarwood	4.0	1991-1992		HB210x.677	D477		
Cherokee (XJ)	Classic	4.0	1996-1996		HB210x.677	D477		
Cherokee (XJ)	Country	4.0	1993-1997		HB210x.677	D477		
Cherokee (XJ)	Laredo	4.0	1990-1992		HB210x.677	D477		
Cherokee (XJ)	Limited	4.0	1990-1992		HB210x.677	D477		
Cherokee (XJ)	Pioneer	4.0	1990-1990		HB210x.677	D477		
Cherokee (XJ)	SE	2.5	1994-1997		HB210x.677	D477		
Cherokee (XJ)	SE	4.0	1994-1997		HB210x.677	D477		
Cherokee (XJ)	Sport	4.0	1990-1997		HB210x.677	D477		
Cherokee (XJ)		2.5	1990-1993		HB210x.677	D477		
Cherokee (XJ)		2.5	1998-2000		HB210x.677	D477		
Cherokee (XJ)		4.0	1990-1993		HB210x.677	D477		
Cherokee (XJ)		4.0	1998-2001		HB210x.677	D477		
CJ5		3.8	1977-1978		HB292x.674	D50		
CJ5		4.2	1977-1978		HB292x.674	D50		
CJ5		5.0	1977-1978		HB292x.674	D50		
CJ7		3.8	1977-1978		HB292x.674	D50		
CJ7		4.2	1977-1978		HB292x.674	D50		
CJ7		5.0	1977-1978		HB292x.674	D50		
Comanche	Eliminator	4.0	1990-1992		HB210x.677	D477		
Comanche		2.5	1990-1992		HB210x.677	D477		
Comanche		4.0	1990-1992		HB210x.677	D477		
Commander	Limited	4.7	2006-2008		HB558x.710	D1080		
Commander	Limited	5.7	2006-2008		HB558x.710	D1080		
Commander	Overland	5.7	2007-2008		HB558x.710	D1080		
Commander	Sport	3.7	2008-2008		HB558x.710	D1080		
Commander	Sport	4.7	2008-2008		HB558x.710	D1080		
Commander		3.7	2006-2007		HB558x.710	D1080		
Commander		4.7	2006-2007		HB558x.710	D1080		
Compass	Limited	2.4	2008-2008		HB435x.622	D866	HB457x.605	D1037
Compass	Sport	2.0	2008-2008		HB435x.622	D866	HB457x.605	D1037
Compass	Sport	2.4	2008-2008		HB435x.622	D866	HB457x.605	D1037
Compass		2.0	2007-2007		HB435x.622	D866	HB457x.605	D1037
Compass		2.4	2007-2007		HB435x.622	D866	HB457x.605	D1037
Grand Cherokee (WJ)	Laredo	4.0	1999-2002	w/ATE Front Caliper	HB380x.700	D790	HB381x.661	D791
Grand Cherokee (WJ)	Laredo	4.0	1999-2002	w/Akebono Front Caliper	HB446x.725	D945	HB381x.661	D791
Grand Cherokee (WJ)	Laredo	4.0	2003-2004		HB446x.725	D945	HB381x.661	D791
Grand Cherokee (WJ)	Laredo	4.7	1999-2002	w/ATE Front Caliper	HB380x.700	D790	HB381x.661	D791
Grand Cherokee (WJ)	Laredo	4.7	1999-2002	w/Akebono Front Caliper	HB446x.725	D945	HB381x.661	D791
Grand Cherokee (WJ)	Laredo	4.7	2003-2004		HB446x.725	D945	HB381x.661	D791
Grand Cherokee (WJ)	Limited	4.0	1999-2002	w/ATE Front Caliper	HB380x.700	D790	HB381x.661	D791
Grand Cherokee (WJ)	Limited	4.0	1999-2002	w/Akebono Front Caliper	HB446x.725	D945	HB381x.661	D791
Grand Cherokee (WJ)	Limited	4.0	2003-2004		HB446x.725	D945	HB381x.661	D791
Grand Cherokee (WJ)	Limited	4.7	1999-2002	w/ATE Front Caliper	HB380x.700	D790	HB381x.661	D791
Grand Cherokee (WJ)	Limited	4.7	1999-2002	w/Akebono Front Caliper	HB446x.725	D945	HB381x.661	D791

CODE Breakdown

HB 245 x .631

Insert Compound Code

Make/Model	Submodel	Engine (Liter)	Years	Note	FRONT		REAR	
					Hawk #	FMSI	Hawk #	FMSI
JEEP CONT.								
Grand Cherokee (WJ)	Limited	4.7	2003-2004		HB446x.725	D945	HB381x.661	D791
Grand Cherokee (WJ)	Overland	4.7	2002-2002	w/ATE Front Caliper	HB380x.700	D790	HB381x.661	D791
Grand Cherokee (WJ)	Overland	4.7	2002-2002	w/Akebono Front Caliper	HB446x.725	D945	HB381x.661	D791
Grand Cherokee (WJ)	Overland	4.7	2003-2004		HB446x.725	D945	HB381x.661	D791
Grand Cherokee (WJ)	Special Edition	4.0	2004-2004		HB446x.725	D945	HB381x.661	D791
Grand Cherokee (WJ)	Special Edition	4.7	2004-2004		HB446x.725	D945	HB381x.661	D791
Grand Cherokee (WJ)		4.0	2002-2002	w/ATE Front Caliper	HB380x.700	D790	HB381x.661	D791
Grand Cherokee (WJ)		4.0	2002-2002	w/Akebono Front Caliper	HB446x.725	D945	HB381x.661	D791
Grand Cherokee (WJ)		4.7	2002-2002	w/ATE Front Caliper	HB380x.700	D790	HB381x.661	D791
Grand Cherokee (WJ)		4.7	2002-2002	w/Akebono Front Caliper	HB446x.725	D945	HB381x.661	D791
Grand Cherokee (WK)		3.7	2006-2006		HB558x.710	D1080		
Grand Cherokee (WK)		4.7	2006-2006		HB558x.710	D1080		
Grand Cherokee (WK)		3.0	2007-2008		HB558x.710	D1080		
Grand Cherokee (WK)		3.7	2005-2008		HB558x.710	D1080		
Grand Cherokee (WK)		4.7	2005-2008		HB558x.710	D1080		
Grand Cherokee (WK)		3.0	2007-2008		HB558x.710	D1080		
Grand Cherokee (WK)		4.7	2005-2008		HB558x.710	D1080		
Grand Cherokee (WK)		5.7	2005-2008		HB558x.710	D1080		
Grand Cherokee (WK)		3.0	2007-2008		HB558x.710	D1080		
Grand Cherokee (WK)		5.7	2006-2008		HB558x.710	D1080		
Grand Cherokee (WK)		6.1	2006-2007		HB563x.656	D1149		
Grand Cherokee (WK)		6.1	2008-2008		HB563x.656	D1149	HB194x.570	D592
Grand Cherokee (ZJ)		5.9	1998-1998		HB210x.677	D477	HB286x.591	D666
Grand Cherokee (ZJ)		4.0	1994-1994		HB210x.677	D477	HB285x.595	D625
Grand Cherokee (ZJ)		4.0	1995-1998		HB210x.677	D477	HB286x.591	D666
Grand Cherokee (ZJ)		5.2	1994-1994		HB210x.677	D477	HB285x.595	D625
Grand Cherokee (ZJ)		5.2	1995-1998		HB210x.677	D477	HB286x.591	D666
Grand Cherokee (ZJ)		4.0	1994-1994		HB210x.677	D477	HB285x.595	D625
Grand Cherokee (ZJ)		4.0	1995-1998		HB210x.677	D477	HB286x.591	D666
Grand Cherokee (ZJ)		5.2	1994-1994		HB210x.677	D477	HB285x.595	D625
Grand Cherokee (ZJ)		5.2	1995-1998		HB210x.677	D477	HB286x.591	D666
Grand Cherokee (ZJ)		4.0	1995-1995		HB210x.677	D477	HB286x.591	D666
Grand Cherokee (ZJ)		4.0	1997-1997		HB210x.677	D477	HB286x.591	D666
Grand Cherokee (ZJ)		5.2	1995-1995		HB210x.677	D477	HB286x.591	D666
Grand Cherokee (ZJ)		5.2	1997-1997		HB210x.677	D477	HB286x.591	D666
Grand Cherokee (ZJ)		4.0	1994-1994		HB210x.677	D477	HB285x.595	D625
Grand Cherokee (ZJ)		4.0	1995-1995		HB210x.677	D477		
Grand Cherokee (ZJ)		5.2	1994-1994		HB210x.677	D477	HB285x.595	D625
Grand Cherokee (ZJ)		5.2	1995-1995		HB210x.677	D477		
Grand Cherokee (ZJ)		4.0	1997-1998		HB210x.677	D477	HB286x.591	D666
Grand Cherokee (ZJ)		5.2	1997-1998		HB210x.677	D477	HB286x.591	D666
Grand Wagoneer		4.2	1984-1986		HB103x.590	D313		
Grand Wagoneer		5.9	1984-1990		HB103x.590	D313		
J10		4.2	1974-1987		HB103x.590	D313		
J10		5.9	1974-1988		HB103x.590	D313		
J10		6.6	1974-1978		HB103x.590	D313		
J20		4.2	1974-1974		HB103x.590	D313		
J20		4.2	1976-1976		HB103x.590	D313		
J20		5.9	1974-1988		HB103x.590	D313		
J20		6.6	1974-1978		HB103x.590	D313		
Liberty (KJ)		3.7	2006-2006		HB373x.689	D844		
Liberty (KJ)	Limited	2.8	2005-2006		HB373x.689	D844		

RACE COMPOUND CODES

DTC-70 - U | DTC-05 - H | MT-4 - L | DR-97 - J
 DTC-60 - G | HT-14 - V | Blue 9012 - E | HP Plus - N
 DTC-30 - W | HT-10 - S | Black - M

STREET COMPOUND CODES

HPS Performance Street - F | SuperDuty - P
 Performance Ceramic - Z
 LTS Light Truck & SUV - Y

Make/Model	Submodel	Engine (Liter)	Years	Note	FRONT		REAR	
					Hawk #	FMSI	Hawk #	FMSI
JEEP CONT.								
Liberty (KJ)	Limited	3.7	2002-2007		HB373x.689	D844		
Liberty (KJ)	Limited	3.7	2008-2008		HB569x.650	D1273		
Liberty (KJ)	Renegade	3.7	2003-2006		HB373x.689	D844		
Liberty (KJ)	Rocky Mountain	3.7	2005-2005		HB373x.689	D844		
Liberty (KJ)	Sport	2.4	2005-2005		HB373x.689	D844		
Liberty (KJ)	Sport	2.8	2005-2006		HB373x.689	D844		
Liberty (KJ)	Sport	3.7	2002-2007		HB373x.689	D844		
Liberty (KJ)	Sport	3.7	2008-2008		HB569x.650	D1273		
Liberty (KJ)		2.4	2002-2004		HB373x.689	D844		
Liberty (KJ)		3.7	2004-2004		HB373x.689	D844		
Patriot	Limited	2.4	2007-2008		HB435x.622	D866	HB457x.605	D1037
Patriot	Sport	2.0	2008-2008		HB435x.622	D866	HB457x.605	D1037
Patriot	Sport	2.4	2008-2008		HB435x.622	D866	HB457x.605	D1037
Patriot		2.0	2007-2007		HB435x.622	D866	HB457x.605	D1037
Patriot		2.4	2007-2007		HB435x.622	D866	HB457x.605	D1037
Wagoneer	Custom	5.9	1974-1976		HB103x.590	D313		
Wagoneer	Custom	6.6	1974-1976		HB103x.590	D313		
Wagoneer	Limited	4.0	1990-1990		HB210x.677	D477		
Wagoneer		2.1	1985-1985		HB103x.590	D313		
Wagoneer		2.5	1984-1985		HB103x.590	D313		
Wagoneer		2.8	1984-1985		HB103x.590	D313		
Wagoneer		3.8	1971-1971		HB103x.590	D313		
Wagoneer		4.2	1972-1973		HB103x.590	D313		
Wagoneer		4.2	1980-1983		HB103x.590	D313		
Wagoneer		5.7	1971-1971		HB103x.590	D313		
Wagoneer		5.9	1972-1983		HB103x.590	D313		
Wagoneer		6.6	1974-1978		HB103x.590	D313		
Wrangler (07-08JK)	Rubicon	3.8	2007-2008		HB569x.650	D1273		
Wrangler (07-08JK)	Sahara	3.8	2007-2008		HB569x.650	D1273		
Wrangler (07-08JK)	Unlimited Rubicon	3.8	2007-2008		HB569x.650	D1273		
Wrangler (07-08JK)	Unlimited Sahara	3.8	2007-2008		HB569x.650	D1273		
Wrangler (07-08JK)	Unlimited X	3.8	2007-2008		HB569x.650	D1273		
Wrangler (07-08JK)	X	3.8	2007-2008		HB569x.650	D1273		
Wrangler (87-95YJ)	Islander	2.5	1990-1991		HB210x.677	D477		
Wrangler (87-95YJ)	Islander	4.0	1991-1992		HB210x.677	D477		
Wrangler (87-95YJ)	Islander	4.2	1990-1990		HB210x.677	D477		
Wrangler (87-95YJ)	Laredo	4.2	1990-1990		HB210x.677	D477		
Wrangler (87-95YJ)	Renegade	4.0	1991-1994		HB210x.677	D477		
Wrangler (87-95YJ)	Rio Grande	2.5	1995-1995		HB210x.677	D477		
Wrangler (87-95YJ)	S	2.5	1991-1994		HB210x.677	D477		
Wrangler (87-95YJ)	S	4.0	1992-1992		HB210x.677	D477		
Wrangler (87-95YJ)	SE	2.5	1995-1995		HB210x.677	D477		
Wrangler (87-95YJ)	SE	4.0	1994-1995		HB210x.677	D477		
Wrangler (97-06TJ)	65th Anniversary Edition	4.0	2006-2006		HB210x.677	D477		
Wrangler (97-06TJ)	Rubicon	4.0	2003-2006		HB210x.677	D477		
Wrangler (97-06TJ)	Sahara	4.0	1997-1997		HB210x.677	D477		
Wrangler (97-06TJ)	Sahara	4.0	2002-2004		HB210x.677	D477		
Wrangler (97-06TJ)	Sport	4.0	1997-1997		HB210x.677	D477		
Wrangler (97-06TJ)	Sport	4.0	2002-2006		HB210x.677	D477		
Wrangler (97-06TJ)	Unlimited	4.0	2004-2006		HB210x.677	D477		
Wrangler (97-06TJ)	Unlimited Rubicon	4.0	2005-2006		HB210x.677	D477		
Wrangler (97-06TJ)	X	4.0	2002-2006		HB210x.677	D477		

CODE Breakdown

HB 245 x .631

Insert Compound Code

Make/Model	Submodel	Engine (Liter)	Years	Note	FRONT		REAR	
					Hawk #	FMSI	Hawk #	FMSI
JEEP CONT.								
Wrangler (97-06TJ)		2.5	1998-2001		HB210x.677	D477		
Wrangler (97-06TJ)		4.0	1998-2001		HB210x.677	D477		
KIA								
Amanti		3.5	2004-2006		HB461x.646	D864		
Optima	EX	2.4	2005-2008		HB368x.665	D924		
Optima	EX	2.7	2005-2008		HB368x.665	D924		
Optima	LX	2.4	2005-2008		HB368x.665	D924		
Optima	LX	2.7	2005-2008		HB368x.665	D924		
Optima		2.4	2001-2001		HB261x.665	D700		
Optima		2.4	2003-2004		HB368x.665	D924		
Optima		2.5	2001-2001		HB261x.665	D700		
Optima		2.7	2003-2004		HB368x.665	D924		
Sedona		3.5	2002-2004		HB461x.646	D864		
Sorento	EX	3.5	2005-2006		HB461x.646	D864		
Sorento	EX	3.8	2007-2008		HB461x.646	D864		
Sorento	LX	3.3	2008-2008		HB461x.646	D864		
Sorento	LX	3.5	2005-2006		HB461x.646	D864		
Sorento	LX	3.8	2007-2007		HB461x.646	D864		
Sorento		3.5	2003-2004		HB461x.646	D864		
Sportage	EX	2.7	2005-2008		HB368x.665	D924		
Sportage	LX	2.0	2005-2008		HB368x.665	D924		
Sportage	LX	2.7	2005-2008		HB368x.665	D924		
LAND ROVER								
Discovery	Series II	4.0	1999-1999		HB469x.705	D676		
Discovery		3.9	1995-1995		HB469x.705	D676		
Discovery		4.0	1996-2002		HB469x.705	D676	HB195x.640	D278
Discovery		4.6	2003-2004		HB469x.705	D676	HB195x.640	D278
Range Rover	Classic	3.9	1995-1995		HB469x.705	D676		
Range Rover	Classic LWB	4.2	1995-1995		HB469x.705	D676		
Range Rover	HSE	4.4	2005-2005		HB454x.715	D992	HB518x.642	D683
Range Rover	HSE	4.6	1996-1998		HB469x.705	D676		
Range Rover	SE	4.0	1995-1998		HB469x.705	D676		
Range Rover		4.0	1999-2000		HB469x.705	D676		
Range Rover		4.4	2003-2004		HB454x.715	D992	HB518x.642	D683
Range Rover		4.6	1999-2002		HB469x.705	D676		
LEXUS								
ES300		3.0	1992-1996		HB318x.669	D697	HB401x.587	D325
ES300		3.0	1997-1999		HB320x.669	D707	HB401x.587	D325
ES300		3.0	2000-2001		HB320x.669	D707		
GS300		3.0	1993-2005		HB375x.669	D619		
GS300		3.0	2006-2006		HB474x.681	D908	HB562x.612	D1113
GS400		4.0	1998-2000		HB375x.669	D619	HB499x.610	D771
GS430		4.3	2001-2005		HB375x.669	D619	HB499x.610	D771
GX470		4.7	2003-2008		HB490x.665	D976	HB477x.610	D606
IS250		2.5	2006-2008		HB566x.688	D1178	HB562x.612	D1113
IS300	Sportcross	3.0	2002-2005		HB375x.669	D619	HB499x.610	D771
IS300		3.0	2001-2005		HB375x.669	D619	HB499x.610	D771
LX450		4.5	1996-1997		HB312x.591	D502	HB477x.610	D606
LX470		4.7	1998-2007		HB313x.685	D772	HB427x.685	D773
LX570		5.7	2008-2009		HB589x.704	D1303	HB590x.692	D1304
RX300		3.0	1999-2001		HB320x.669	D707	HB401x.587	D325

RACE COMPOUND CODES

DTC-70 - U	DTC-05 - H	MT-4 - L	DR-97 - J
DTC-60 - G	HT-14 - V	Blue 9012 - E	HP Plus - N
DTC-30 - W	HT-10 - S	Black - M	

STREET COMPOUND CODES

HPS Performance Street - F	SuperDuty - P
Performance Ceramic - Z	
LTS Light Truck & SUV - Y	

Make/Model	Submodel	Engine		Note	FRONT		REAR	
		(Liter)	Years		Hawk #	FMSI	Hawk #	FMSI
LEXUS CONT.								
SC300		3.0	1996-1998		HB318x.669	D697		
SC430		4.3	2002-2006		HB375x.669	D619	HB499x.610	D771
SC430		4.3	2008-2008		HB375x.669	D619	HB499x.610	D771
LINCOLN								
Blackwood		5.4	2002-2002		HB266x.650	D679	HB301x.630	D711
Continental	Executive	3.8	1991-1992		HB240x.620	D421	HB580x.627	D545
Continental	Givenchy	5.0	1987-1987		HB125x.650	D199		
Continental	Signature	3.8	1988-1992		HB240x.620	D421	HB580x.627	D545
Continental		2.4	1984-1985		HB125x.650	D199		
Continental		3.8	1982-1982		HB125x.650	D199		
Continental		3.8	1988-1990		HB240x.620	D421	HB580x.627	D545
Continental		4.6	1995-1995		HB416x.689	D598	HB417x.659	D610
Continental		4.6	1997-2002		HB416x.689	D598	HB417x.659	D610
Continental		5.0	1982-1987		HB125x.650	D199		
Continental		6.6	1977-1979		HB292x.674	D50		
Continental		7.5	1973-1978		HB292x.674	D50		
LS	Sport	3.9	2006-2006		HB376x.665	D805	HB428x.650	D806
LS		3.0	2000-2005		HB376x.665	D805	HB428x.650	D806
LS		3.9	2000-2005		HB376x.665	D805	HB428x.650	D806
Mark IV		7.5	1973-1976		HB292x.674	D50		
Mark LT		5.4	2006-2008		HB455x.785	D1083	HB456x.705	D1012
Mark V		6.6	1977-1979		HB292x.674	D50		
Mark V		7.5	1977-1978		HB292x.674	D50		
Mark VI		5.0	1982-1983		HB125x.650	D199		
Mark VII	Bill Blass	5.0	1991-1992		HB125x.650	D199	HB580x.627	D545
Mark VII	LSC	5.0	1991-1992		HB125x.650	D199	HB580x.627	D545
Mark VII		2.4	1984-1985		HB125x.650	D199		
Mark VII		5.0	1984-1987		HB125x.650	D199		
Mark VIII	LSC	4.6	1995-1998		HB416x.689	D598		
Mark VIII		4.6	1993-1995		HB416x.689	D598		
Mark VIII		4.6	1997-1998		HB416x.689	D598		
MKZ		3.5	2007-2008		HB565x.688	D1164	HB564x.567	D1161
Navigator	L	5.4	2008-2008		HB578x.735	D1278	HB579x.785	D1279
Navigator	L Luxury	5.4	2007-2007		HB578x.735	D1278	HB579x.785	D1279
Navigator	L Ultimate	5.4	2007-2007		HB578x.735	D1278	HB579x.785	D1279
Navigator	Luxury	5.4	2006-2006		HB462x.827	D934	HB463x.787	D935
Navigator	Luxury	5.4	2007-2007		HB578x.735	D1278	HB579x.785	D1279
Navigator	Ultimate	5.4	2006-2006		HB462x.827	D934	HB463x.787	D935
Navigator	Ultimate	5.4	2007-2007		HB578x.735	D1278	HB579x.785	D1279
Navigator		5.4	1998-2002		HB299x.650	D702	HB301x.630	D711
Navigator		5.4	2003-2005		HB462x.827	D934	HB463x.787	D935
Navigator		5.4	2008-2008		HB578x.735	D1278	HB579x.785	D1279
Town Car	Cartier	4.6	1991-1994		HB125x.650	D199		
Town Car	Cartier	4.6	1995-1995		HB205x.672	D659		
Town Car	Cartier	4.6	1996-1996		HB205x.672	D659	HB341x.618	D674
Town Car	Cartier	4.6	2003-2003		HB433x.654	D997	HB443x.614	D932
Town Car	Cartier	5.0	1987-1990		HB125x.650	D199		
Town Car	Designer Series	4.6	2006-2007		HB433x.654	D997	HB301x.630	D711
Town Car	Executive	4.6	1991-1994		HB125x.650	D199		
Town Car	Executive	4.6	1995-1997		HB205x.672	D659		
Town Car	Executive	4.6	2003-2004		HB433x.654	D997	HB443x.614	D932
Town Car	Executive	4.6	2005-2007		HB433x.654	D997	HB301x.630	D711

CODE Breakdown

HB 245 x .631

Insert Compound Code

Make/Model	Submodel	Engine (Liter)	Years	Note	FRONT		REAR	
					Hawk #	FMSI	Hawk #	FMSI
LINCOLN CONT.								
Town Car	Executive L	4.6	2005-2007		HB433x.654	D997	HB301x.630	D711
Town Car	Jack Nicklaus	4.6	1993-1993		HB125x.650	D199		
Town Car	Signature	4.6	1991-1994		HB125x.650	D199		
Town Car	Signature	4.6	1995-1997		HB205x.672	D659		
Town Car	Signature	4.6	2003-2004		HB433x.654	D997	HB443x.614	D932
Town Car	Signature	4.6	2005-2007		HB433x.654	D997	HB301x.630	D711
Town Car	Signature	5.0	1987-1990		HB125x.650	D199		
Town Car	Signature L	4.6	2005-2007		HB433x.654	D997	HB301x.630	D711
Town Car	Signature Limited	4.6	2005-2007		HB433x.654	D997	HB301x.630	D711
Town Car	Signature SE	5.0	1989-1989		HB125x.650	D199		
Town Car	Touring Edition	4.6	1997-1997		HB205x.672	D659		
Town Car	Tournament Edition	4.6	1994-1994		HB125x.650	D199		
Town Car	Ultimate	4.6	2004-2004		HB433x.654	D997	HB443x.614	D932
Town Car		5.0	1982-1990		HB125x.650	D199		
Zephyr		3.0	2006-2006		HB565x.688	D1164	HB564x.567	D1161
LOTUS								
Elise		1.8	2005-2005		HB180x.560	D961	HB278x.583	D491
MAZDA								
3	i	2.0	2005-2006		HB519x.682	D1044	HB478x.605	D1095
3	i	2.0	2007-2008		HB519x.682	D1044	HB571x.605	D973
3	Mazdaspeed	2.3	2007-2007		HB549x.702	D1186	HB571x.605	D973
3	Mazdaspeed	2.3	2008-2008		HB519x.682	D1044	HB571x.605	D973
3	S	2.3	2005-2006		HB519x.682	D1044	HB478x.605	D1095
3	S	2.3	2007-2008		HB519x.682	D1044	HB571x.605	D973
3	SP23	2.3	2005-2005		HB519x.682	D1044	HB478x.605	D1095
3	SP23	2.3	2005-2005		HB519x.682	D1044	HB571x.605	D973
5	Grand Touring	2.3	2008-2008		HB519x.682	D1044	HB571x.605	D973
5	Sport	2.3	2006-2006		HB519x.682	D1044		
5	Sport	2.3	2008-2008		HB519x.682	D1044	HB571x.605	D973
5	Touring	2.3	2006-2006		HB519x.682	D1044		
5	Touring	2.3	2008-2008		HB519x.682	D1044	HB571x.605	D973
6	i	2.3	2005-2005		HB459x.700	D957	HB158x.515	D482
6	i	2.3	2008-2008		HB565x.688	D1164	HB564x.567	D1161
6	Mazdaspeed	2.3	2008-2008		HB565x.688	D1164	HB564x.567	D1161
6	S	3.0	2005-2005		HB459x.700	D957		
6	S	3.0	2006-2007		HB549x.702	D1186	HB564x.567	D1161
6	S	3.0	2008-2008		HB565x.688	D1164	HB564x.567	D1161
323		1.6	1990-1991		HB246x.567	D473		
626	DX	2.0	1993-1994		HB211x.606	D637	HB212x.535	D584
626	DX	2.0	1995-1997		HB211x.606	D637		
626	DX	2.0	1998-1998	Drum	HB211x.606	D637		
626	ES	2.5	1993-1997		HB211x.606	D637	HB212x.535	D584
626	ES	2.5	1998-1998	Disc	HB489x.630	D755	HB212x.535	D584
626	ES	2.5	2002-2002	Drum	HB211x.606	D637		
626	ES	2.5	2002-2002	Disc	HB489x.630	D755	HB212x.535	D584
626	LX	2.0	1993-1997		HB211x.606	D637	HB212x.535	D584
626	LX	2.0	1998-1998	Drum	HB211x.606	D637		
626	LX	2.0	1998-1998	Disc	HB489x.630	D755	HB212x.535	D584
626	LX	2.0	2002-2002	Drum	HB211x.606	D637	HB212x.535	D584
626	LX	2.0	2002-2002	Disc	HB489x.630	D755	HB212x.535	D584
626	LX	2.5	1994-1997		HB211x.606	D637	HB212x.535	D584
626	LX	2.5	1998-1998	Drum	HB211x.606	D637		

RACE COMPOUND CODES

DTC-70 - U	DTC-05 - H	MT-4 - L	DR-97 - J
DTC-60 - G	HT-14 - V	Blue 9012 - E	HP Plus - N
DTC-30 - W	HT-10 - S	Black - M	

STREET COMPOUND CODES

HPS Performance Street - F	SuperDuty - P
Performance Ceramic - Z	
LTS Light Truck & SUV - Y	

Make/Model	Submodel	Engine (Liter)	Years	Note	FRONT		REAR	
					Hawk #	FMSI	Hawk #	FMSI
MAZDA CONT.								
626	LX	2.5	1998-1998	Disc	HB489x.630	D755	HB212x.535	D584
626	LX	2.5	2002-2002	Drum	HB211x.606	D637		
626	LX	2.5	2002-2002	Disc	HB489x.630	D755	HB212x.535	D584
626		2.0	1999-2001	Drum	HB211x.606	D637		
626		2.0	1999-2001	Disc	HB489x.630	D755	HB212x.535	D584
626		2.5	1999-2001	Drum	HB211x.606	D637		
626		2.5	1999-2001	Disc	HB489x.630	D755	HB212x.535	D584
929	S	3.0	1990-1991		HB407x.602	D389		
929		3.0	1988-1991		HB407x.602	D389		
B1800		1.8	1978-1978		HB150x.555	D76		
B2000		2.0	1979-1984		HB150x.555	D76		
B2300		2.3	1994-1994		HB279x.594	D249		
B2300		2.3	1995-1997		HB283x.650	D652		
B2300		2.3	2003-2008		HB472x.650	D833		
B2500		2.5	1998-2001		HB283x.650	D652		
B3000	DS	3.0	2006-2007		HB472x.650	D833		
B3000		3.0	1994-1994		HB279x.594	D249		
B3000		3.0	1995-1996		HB283x.650	D652		
B3000		3.0	1998-2002		HB283x.650	D652		
B3000		3.0	2003-2007		HB472x.650	D833		
B4000	SE	4.0	2006-2008		HB472x.650	D833		
B4000		4.0	1994-1994		HB279x.594	D249		
B4000		4.0	1995-2002		HB283x.650	D652		
B4000		4.0	2003-2008		HB472x.650	D833		
Cosmo		1.3	1976-1978		HB152x.540	D131		
Miata	Mazdaspeed	1.8	2004-2005		HB431x.606	D890	HB468x.492	D1002
Miata		1.6	1990-1993		HB148x.560	D525	HB157x.484	D458
Miata		1.8	1994-1997		HB149x.505	D635	HB159x.492	D636
Miata		1.8	1999-2000		HB149x.505	D635	HB159x.492	D636
Miata		1.8	2001-2003	w/o Sport Suspension	HB149x.505	D635	HB159x.492	D636
Miata		1.8	2001-2005	w/ Sport Suspension	HB431x.606	D890	HB442x.496	D891
Millenia	L	2.5	1996-1997		HB419x.634	D643		
Millenia	S	2.3	1995-1998		HB419x.634	D643		
Millenia	S	2.3	2002-2002		HB419x.634	D643		
Millenia		2.3	1999-2001		HB419x.634	D643		
Millenia		2.5	1995-2002		HB419x.634	D643		
MPV		2.5	2000-2001		HB379x.626	D551		
MPV		2.6	1992-1994		HB379x.626	D551		
MPV		3.0	1992-1998		HB379x.626	D551		
MX-3	GS	1.8	1992-1994		HB246x.567	D473		
MX-3		1.6	1992-1995		HB246x.567	D473		
MX-5 Miata	Club Spec	2.0	2006-2006		HB522x.565	D1179	HB523x.539	D1180
MX-5 Miata	Grand Touring	2.0	2006-2008		HB522x.565	D1179	HB523x.539	D1180
MX-5 Miata	Sport	2.0	2006-2008		HB522x.565	D1179	HB523x.539	D1180
MX-5 Miata	SV	2.0	2007-2008		HB522x.565	D1179	HB523x.539	D1180
MX-5 Miata	Touring	2.0	2006-2008		HB522x.565	D1179	HB523x.539	D1180
MX-5 Miata		2.0	2006-2006		HB522x.565	D1179	HB523x.539	D1180
MX-6	LS	2.5	1993-1997		HB211x.606	D637	HB212x.535	D584
MX-6	RS	2.0	1996-1997		HB211x.606	D637	HB212x.535	D584
MX-6		2.0	1993-1995		HB211x.606	D637	HB212x.535	D584
Navajo	DX	4.0	1992-1994		HB279x.594	D249		
Navajo	LX	4.0	1991-1994		HB279x.594	D249		

CODE Breakdown

HB 245 x .631

Insert Compound Code

Make/Model	Submodel	Engine (Liter)	Years	Note	FRONT		REAR	
					Hawk #	FMSI	Hawk #	FMSI
MAZDA CONT.								
Protegé	4WD	1.8	1990-1991		HB246x.567	D473	HB157x.484	D458
Protegé	DX	1.5	1996-1998		HB246x.567	D473		
Protegé	DX	1.8	1991-1994		HB246x.567	D473		
Protegé	DX	2.0	2002-2003		HB211x.606	D637		
Protegé	ES	1.8	1995-1998		HB246x.567	D473	HB159x.492	D636
Protegé	ES	2.0	2002-2003		HB211x.606	D637	HB436x.535	D892
Protegé	LX	1.5	1996-1998		HB246x.567	D473		
Protegé	LX	1.8	1990-1994		HB246x.567	D473	HB157x.484	D458
Protegé	LX	2.0	2002-2003		HB211x.606	D637		
Protegé	Mazdaspeed	2.0	2003-2003		HB489x.630	D755	HB436x.535	D892
Protegé	MP3	2.0	2001-2001		HB211x.606	D637	HB436x.535	D892
Protegé	SE	1.8	1990-1990		HB246x.567	D473		
Protegé		1.5	1995-1995		HB246x.567	D473		
Protegé		1.6	2001-2001		HB211x.606	D637		
Protegé		1.8	1994-1994		HB246x.567	D473		
Protegé		1.8	1999-2000		HB211x.606	D637		
Protegé		2.0	2001-2001		HB211x.606	D637		
Rotary Pickup		1.3	1976-1976		HB150x.555	D76		
RX-2		1.1	1971-1974		HB150x.555	D76		
RX-4		1.3	1974-1978		HB150x.555	D76		
RX-7	GXL	1.3	1990-1990	w/Standard Suspension	HB152x.540	D131	HB158x.515	D482
RX-7	GXL	1.3	1990-1990	w/Electronic Adjustable Suspension	HB155x.580	D331	HB158x.515	D482
RX-7	U	1.3	1990-1990	w/Standard Suspension	HB152x.540	D131	HB158x.515	D482
RX-7	U	1.3	1990-1990	w/Electronic Adjustable Suspension	HB155x.580	D331	HB158x.515	D482
RX-7		1.1	1979-19885		HB150x.555	D76		
RX-7		1.1	1981-1985		HB150x.555	D76	HB151x.505	D235
RX-7		1.3	1984-1985		HB152x.540	D131	HB158x.515	D482
RX-7		1.3	1986-1991	w/Standard Suspension	HB152x.540	D131	HB158x.515	D482
RX-7		1.3	1986-1991	w/Electronic Adjustable Suspension	HB155x.580	D331	HB158x.515	D482
RX-7		1.3	1993-1995	w/Electronic Adjustable Suspension	HB155x.580	D331	HB158x.515	D482
RX-8	Grand Touring	1.3	2008-2009		HB470x.643	D1009		
RX-8	Sport	1.3	2008-2009		HB470x.643	D1009		
RX-8	Touring	1.3	2008-2009		HB470x.643	D1009		
RX-8		1.3	2004-2007		HB470x.643	D1009	HB378x.565	D1008
Tribute	DX	2.0	2002-2004		HB473x.752	D843		
Tribute	DX	3.0	2002-2002		HB473x.752	D843		
Tribute	ES	3.0	2002-2004		HB473x.752	D843		
Tribute	i	2.3	2005-2006		HB473x.752	D843		
Tribute	LX	3.0	2002-2004		HB473x.752	D843		
Tribute	S	3.0	2005-2005		HB473x.752	D843		
Tribute		2.0	2001-2001		HB473x.752	D843		
Tribute		3.0	2001-2001		HB473x.752	D843		
MERCEDES-BENZ								
230		2.3	1977-1978		HB207x.580	D145	HB172x.595	D31
280		2.8	1973-1975		HB207x.580	D145	HB172x.595	D31
190D	2.2	2.2	1984-1985		HB195x.640	D278		
190D	2.5	2.5	1986-1989		HB195x.640	D278		
190DT		2.5	1987-1987		HB195x.640	D278		
190E	2.3	2.3	1984-1988		HB195x.640	D278		
190E	2.3	2.3	1991-1993		HB195x.640	D278		
190E	2.6	2.6	1987-1993		HB195x.640	D278		
190E	2.3-16	2.3	1986-1987		HB195x.640	D278		

RACE COMPOUND CODES

DTC-70 - U	DTC-05 - H	MT-4 - L	DR-97 - J
DTC-60 - G	HT-14 - V	Blue 9012 - E	HP Plus - N
DTC-30 - W	HT-10 - S	Black - M	

STREET COMPOUND CODES

HPS Performance Street - F	SuperDuty - P
Performance Ceramic - Z	
LTS Light Truck & SUV - Y	

Make/ Model	Submodel	Engine		Note	FRONT		REAR	
		(Liter)	Years		Hawk #	FMSI	Hawk #	FMSI
MERCEDES-BENZ CONT.								
240D		2.4	1974-1982		HB207x.580	D145	HB172x.595	D31
280C		2.8	1973-1974		HB207x.580	D145	HB172x.595	D31
280C		2.8	1975-1976		HB207x.580	D145		
280CE		2.8	1978-1979		HB207x.580	D145	HB172x.595	D31
280CE		2.8	1980-1981		HB207x.580	D145		
280E		2.8	1980-1981		HB207x.580	D145		
280S		2.8	1976-1976		HB207x.580	D145	HB172x.595	D31
280SE	4.5	4.5	1973-1973		HB207x.580	D145	HB172x.595	D31
280SE		2.8	1978-1979		HB207x.580	D145	HB172x.595	D31
280SEL		4.5	1973-1973		HB207x.580	D145		
300CD		3.0	1978-1981		HB207x.580	D145	HB172x.595	D31
300CDT		3.0	1982-1985		HB207x.580	D145	HB172x.595	D31
300D		3.0	1976-1981		HB207x.580	D145		
300DT		3.0	1982-1985		HB207x.580	D145	HB172x.595	D31
300SD		3.0	1978-1985		HB207x.580	D145	HB172x.595	D31
300SE		3.0	1966-1966		HB171x.590	D45	HB172x.595	D31
300SE		3.0	1990-1990		HB207x.580	D145	HB172x.595	D31
300SEL		2.8	1968-1969		HB171x.590	D45	HB172x.595	D31
300SEL		3.5	1970-1971		HB171x.590	D45	HB172x.595	D31
300SEL		4.5	1972-1972		HB171x.590	D45	HB172x.595	D31
300SEL		6.3	1970-1971		HB171x.590	D45	HB172x.595	D31
300TD		3.0	1979-1981		HB207x.580	D145		
300TDT		3.0	1982-1985		HB207x.580	D145	HB172x.595	D31
350SD		3.4	1991-1991		HB207x.580	D145	HB172x.595	D31
350SDL		3.4	1990-1991		HB207x.580	D145	HB172x.595	D31
380SE		3.8	1985-1985		HB207x.580	D145		
380SEL		3.8	1982-1982		HB207x.580	D145	HB172x.595	D31
380SL		3.8	1982-1985		HB207x.580	D145		
420SEL		4.2	1989-1990		HB207x.580	D145	HB172x.595	D31
450SE		4.5	1973-1976		HB207x.580	D145	HB172x.595	D31
450SEL	6.9	6.8	1977-1979		HB207x.580	D145	HB172x.595	D31
450SEL		4.5	1973-1980		HB207x.580	D145	HB172x.595	D31
450SL		4.5	1973-1980		HB207x.580	D145	HB172x.595	D31
450SLC		4.5	1973-1980		HB207x.580	D145	HB172x.595	D31
500SEC		5.0	1985-1985		HB207x.580	D145	HB172x.595	D31
500SEL		5.0	1985-1985		HB207x.580	D145	HB172x.595	D31
560SEC		5.6	1986-1991		HB207x.580	D145	HB172x.595	D31
560SEL		5.6	1986-1991		HB207x.580	D145	HB172x.595	D31
560SL		5.6	1986-1989		HB199x.702	D443	HB172x.595	D31
C230	Kompressor	1.8	2005-2005		HB504x.740	D872		
C230	Sport	2.5	2006-2006		HB504x.740	D872		
C240	4Matic	2.6	2003-2005		HB504x.740	D872		
C240		2.6	2001-2005		HB504x.740	D872		
C280	Luxury	3.0	2006-2007		HB504x.740	D872		
C320	4Matic	3.2	2003-2005		HB504x.740	D872		
C320		3.2	2001-2005		HB504x.740	D872		
C350	Luxury	3.5	2006-2007		HB504x.740	D872		
C350	Sport	3.5	2006-2007		HB504x.740	D872		
C43	AMG	4.3	1998-2000		HB497x.776	D682		
CL55	AMG	5.5	2001-2003		HB497x.776	D682		
CLK320		3.2	1998-2002		HB495x.756	D740		
CLK320		3.2	2003-2005		HB504x.740	D872		

CODE Breakdown

HB 245 x .631

Insert Compound Code

Make/Model	Submodel	Engine (Liter)	Years	Note	FRONT		REAR	
					Hawk #	FMSI	Hawk #	FMSI
MERCEDES-BENZ CONT.								
CLK350		3.5	2006-2008		HB504x.740	D872		
CLK430		4.3	1999-2003		HB495x.756	D740		
E300D		3.0	1998-1999		HB495x.756	D740		
E320		3.2	1996-1999		HB495x.756	D740		
E350	4Matic	3.5	2006-2006		HB497x.776	D682		
E420		4.2	1997-1997		HB495x.756	D740		
E500	4Matic	5.0	2005-2006		HB497x.776	D682		
E55	AMG	5.5	1999-2002		HB497x.776	D682		
ML320		3.2	1998-2002		HB505x.654	D760	HB176x.614	D641
ML350		3.7	2003-2005		HB505x.654	D760	HB176x.614	D641
ML430		4.3	1999-1999		HB505x.654	D760	HB176x.614	D641
S430	4Matic	4.3	2005-2006		HB497x.776	D682		
S430		4.3	2003-2004		HB497x.776	D682		
S500	4Matic	5.0	2005-2006		HB497x.776	D682		
S500		5.0	2003-2004		HB497x.776	D682		
SLK280		3.0	2006-2008		HB504x.740	D872		
SLK32	AMG	3.2	2002-2004		HB497x.776	D682		
MERCURY								
Colony Park		5.0	1981-1982		HB125x.650	D199		
Colony Park		5.0	1984-1991		HB125x.650	D199		
Colony Park		5.8	1981-1981		HB125x.650	D199		
Cougar	Brougham	5.0	1977-1977		HB292x.674	D50		
Cougar	Brougham	5.8	1977-1977		HB292x.674	D50		
Cougar	Brougham	6.6	1977-1977		HB292x.674	D50		
Cougar	Brougham Villager	5.8	1977-1977		HB292x.674	D50		
Cougar	Brougham Villager	6.6	1977-1977		HB292x.674	D50		
Cougar	LS	3.8	1989-1992		HB240x.620	D421		
Cougar	LS	5.0	1991-1992		HB240x.620	D421		
Cougar	S	2.5	2001-2001		HB420x.724	D648		
Cougar	XR-7	3.8	1989-1990		HB240x.620	D421	HB580x.627	D545
Cougar	XR-7	3.8	1993-1997		HB182x.660	D600		
Cougar	XR-7	4.6	1994-1997		HB182x.660	D600		
Cougar	XR-7	5.0	1977-1979		HB292x.674	D50		
Cougar	XR-7	5.0	1987-1988		HB263x.650	D431		
Cougar	XR-7	5.0	1991-1992		HB240x.620	D421	HB580x.627	D545
Cougar	XR-7	5.0	1993-1993		HB182x.660	D600		
Cougar	XR-7	5.8	1974-1974		HB292x.674	D50		
Cougar	XR-7	5.8	1976-1979		HB292x.674	D50		
Cougar	XR-7	6.6	1974-1974		HB292x.674	D50		
Cougar	XR-7	6.6	1976-1978		HB292x.674	D50		
Cougar	XR-7	7.5	1974-1974		HB292x.674	D50		
Cougar	XR-7	7.5	1976-1976		HB292x.674	D50		
Cougar		2.0	1999-2002		HB420x.724	D648		
Cougar		2.5	1999-2002		HB420x.724	D648		
Cougar		5.0	1977-1979		HB292x.674	D50		
Cougar		5.8	1975-1975		HB292x.674	D50		
Cougar		5.8	1977-1979		HB292x.674	D50		
Cougar		6.6	1975-1975		HB292x.674	D50		
Cougar		6.6	1977-1978		HB292x.674	D50		
Cougar		7.5	1975-1975		HB292x.674	D50		
Grand Marquis	Colony Park	5.0	1983-1983		HB125x.650	D199		
Grand Marquis	GS	4.6	2006-2008		HB433x.654	D997		

RACE COMPOUND CODES

DTC-70 - U	DTC-05 - H	MT-4 - L	DR-97 - J
DTC-60 - G	HT-14 - V	Blue 9012 - E	HP Plus - N
DTC-30 - W	HT-10 - S	Black - M	

STREET COMPOUND CODES

HPS Performance Street - F	SuperDuty - P
Performance Ceramic - Z	
LTS Light Truck & SUV - Y	

Make/Model	Submodel	Engine		Note	FRONT		REAR	
		(Liter)	Years		Hawk #	FMSI	Hawk #	FMSI
MERCURY CONT.								
Grand Marquis	LS	4.6	2006-2008		HB433x.654	D997		
Grand Marquis		4.2	1981-1982		HB125x.650	D199		
Grand Marquis		4.6	1992-1994		HB125x.650	D199		
Grand Marquis		4.6	1995-1995		HB205x.672	D659		
Grand Marquis		4.6	1996-1996	w/Steel Piston	HB205x.672	D659	HB341x.618	D674
Grand Marquis		4.6	1996-1996	w/Phenolic Piston	HB205x.672	D659	HB353x.618	D690
Grand Marquis		4.6	1997-1997		HB205x.672	D659	HB353x.618	D690
Grand Marquis		4.6	1998-2002		HB294x.646	D748	HB353x.618	D690
Grand Marquis		4.6	2003-2005		HB433x.654	D997		
Grand Marquis		5.0	1981-1991		HB125x.650	D199		
Grand Marquis		5.8	1978-1978		HB292x.674	D50		
Grand Marquis		5.8	1981-1981		HB125x.650	D199		
Grand Marquis		5.8	1986-1986		HB125x.650	D199		
Grand Marquis		6.6	1975-1978		HB292x.674	D50		
Grand Marquis		7.5	1975-1978		HB292x.674	D50		
Marauder		4.6	2003-2004		HB433x.654	D997	HB443x.614	D932
Mariner	Convenience	2.3	2006-2007		HB473x.752	D843		
Mariner	Hybrid	2.3	2007-2007		HB473x.752	D843		
Mariner	Luxury	3.0	2006-2007		HB473x.752	D843		
Mariner	Premier	3.0	2005-2007		HB473x.752	D843		
Mariner		2.3	2005-2005		HB473x.752	D843		
Marquis		5.8	1973-1973		HB292x.674	D50		
Marquis		6.6	1973-1975		HB292x.674	D50		
Marquis		7.0	1973-1973		HB292x.674	D50		
Marquis		7.5	1973-1975		HB292x.674	D50		
Milan	Premier	2.3	2006-2008		HB565x.688	D1164	HB564x.567	D1161
Milan	Premier	3.0	2006-2008		HB565x.688	D1164	HB564x.567	D1161
Milan		2.3	2006-2008		HB565x.688	D1164	HB564x.567	D1161
Milan		3.0	2006-2008		HB565x.688	D1164	HB564x.567	D1161
Montego	GT	5.0	1972-1973		HB292x.674	D50		
Montego	GT	5.8	1972-1973		HB292x.674	D50		
Montego	GT	6.6	1972-1973		HB292x.674	D50		
Montego	GT	7.0	1972-1973		HB292x.674	D50		
Montego	MX	4.1	1972-1973		HB292x.674	D50		
Montego	MX	5.0	1972-1974		HB292x.674	D50		
Montego	MX	5.8	1972-1976		HB292x.674	D50		
Montego	MX	6.6	1972-1976		HB292x.674	D50		
Montego	MX	7.0	1972-1973		HB292x.674	D50		
Montego	MX	7.5	1973-1973		HB292x.674	D50		
Montego	MX	7.5	1975-1976		HB292x.674	D50		
Montego	MX Brougham	4.1	1972-1972		HB292x.674	D50		
Montego	MX Brougham	5.0	1972-1974		HB292x.674	D50		
Montego	MX Brougham	5.8	1972-1976		HB292x.674	D50		
Montego	MX Brougham	6.6	1972-1976		HB292x.674	D50		
Montego	MX Brougham	7.0	1972-1973		HB292x.674	D50		
Montego	MX Brougham	7.5	1974-1976		HB292x.674	D50		
Montego	Villager	4.1	1972-1972		HB292x.674	D50		
Montego	Villager	5.0	1972-1974		HB292x.674	D50		
Montego	Villager	5.8	1972-1976		HB292x.674	D50		
Montego	Villager	6.6	1972-1976		HB292x.674	D50		
Montego	Villager	7.0	1972-1973		HB292x.674	D50		
Montego	Villager	7.5	1974-1976		HB292x.674	D50		

CODE Breakdown

HB 245 x .631

Insert Compound Code

Make/Model	Submodel	Engine (Liter)	Years	Note	FRONT		REAR	
					Hawk #	FMSI	Hawk #	FMSI
MERCURY CONT.								
Montego		4.1	1972-1974		HB292x.674	D50		
Montego		5.0	1972-1974		HB292x.674	D50		
Montego		5.8	1972-1976		HB292x.674	D50		
Montego		6.6	1972-1976		HB292x.674	D50		
Montego		7.0	1972-1973		HB292x.674	D50		
Montego		7.5	1976-1976		HB292x.674	D50		
Mountaineer	Premier	4.0	2004-2004		HB472x.650	D833	HB520x.575	D881
Mountaineer	Premier	4.6	2004-2004		HB472x.650	D833	HB520x.575	D881
Mountaineer		4.0	1998-2001		HB283x.650	D652	HB287x.571	D667
Mountaineer		4.0	2002-2004		HB472x.650	D833	HB520x.575	D881
Mountaineer		4.0	2005-2005		HB472x.650	D833		
Mountaineer		4.6	2002-2004		HB472x.650	D833	HB520x.575	D881
Mountaineer		4.6	2005-2005		HB472x.650	D833		
Mountaineer		5.0	1997-2001		HB283x.650	D652	HB287x.571	D667
Mystique	GS	2.0	1995-1998		HB420x.724	D648	HB510x.580	D661
Mystique	GS	2.5	1995-1997		HB420x.724	D648	HB510x.580	D661
Mystique	LS	2.0	1995-1997		HB420x.724	D648	HB510x.580	D661
Mystique	LS	2.5	1996-1998		HB420x.724	D648	HB510x.580	D661
Mystique	Young America	2.5	1995-1995		HB420x.724	D648	HB510x.580	D661
Mystique		2.0	1999-2000		HB420x.724	D648	HB510x.580	D661
Mystique		2.5	1999-2000		HB420x.724	D648	HB510x.580	D661
Sable		3.0	1989-1993		HB240x.620	D421		
Sable		3.0	1994-2000		HB347x.689	D601	HB417x.659	D610
Sable		3.0	2002-2005		HB416x.689	D598	HB417x.659	D610
Sable		3.8	1989-1993		HB240x.620	D421		
Sable		3.8	1994-1995		HB347x.689	D601	HB417x.659	D610
Tracer	LS	2.0	1997-1998		HB246x.567	D473	HB159x.492	D636
Tracer	LTS	1.8	1991-1996		HB246x.567	D473	HB157x.484	D458
Tracer	Trio	1.9	1994-1996		HB246x.567	D473		
Tracer	Trio	2.0	1997-1998		HB246x.567	D473	HB159x.492	D636
Tracer		1.9	1991-1993		HB246x.567	D473	HB157x.484	D458
Villager		3.0	1993-1998		HB414x.622	D576		
Villager		3.3	1999-2002		HB414x.622	D576		
MG								
MGB	GT	1.8	1967-1974		HB132x.580	D27		
MGB		1.8	1967-1980		HB132x.580	D27		
MGB		3.5	1975-1977		HB132x.580	D27		
Midget		1.1	1966-1966		HB123x.535	D61		
Midget		1.3	1967-1974		HB123x.535	D61		
Midget		1.5	1975-1979		HB123x.535	D61		
MINI								
Cooper	S	1.6	2005-2006	John Cooper Works	HB560x.677	D1204	HB445x.610	D1060
Cooper	S	1.6	2005-2007		HB444x.685	D939	HB445x.610	D1060
Cooper	S	1.6	2007-2007	John Cooper Works	HB560x.677	D1204	HB574x.636	D1309
Cooper	S	1.6	2008-2008		HB560x.677	D1204	HB445x.610	D1060
Cooper	S Clubman	1.6	2008-2008		HB560x.677	D1204	HB574x.636	D1309
Cooper		1.6	2002-2006		HB444x.685	D939	HB445x.610	D1060
Cooper		1.6	2007-2008		HB570x.666	D1308	HB574x.636	D1309
Cooper		1.6	2008-2008	John Cooper Works	HB444x.685	D939	HB445x.610	D1060
MITSUBISHI								
3000GT	SL	3.0	1991-1999		HB214x.618	D530	HB367x.585	D383

RACE COMPOUND CODES

DTC-70 - U	DTC-05 - H	MT-4 - L	DR-97 - J
DTC-60 - G	HT-14 - V	Blue 9012 - E	HP Plus - N
DTC-30 - W	HT-10 - S	Black - M	

STREET COMPOUND CODES

HPS Performance Street - F	SuperDuty - P
Performance Ceramic - Z	
LTS Light Truck & SUV - Y	

Make/ Model	Submodel	Engine		Note	FRONT		REAR	
		(Liter)	Years		Hawk #	FMSI	Hawk #	FMSI
MITSUBISHI CONT.								
3000GT	Spyder SL	3.0	1995-1996		HB214x.618	D530	HB367x.585	D383
3000GT	VR-4	3.0	1991-1993		HB120x.560	D531		
3000GT	VR-4	3.0	1994-1998		HB120x.560	D531	HB201x.620	D631
3000GT		3.0	1991-1999		HB214x.618	D530	HB367x.585	D383
Diamante	ES	3.0	1993-1996		HB214x.618	D530	HB367x.585	D383
Diamante	ES	3.5	1997-1998		HB214x.618	D530		
Diamante	LS	3.0	1993-1995		HB214x.618	D530	HB367x.585	D383
Diamante	LS	3.5	1997-1998		HB214x.618	D530		
Diamante		3.0	1992-1992		HB214x.618	D530		
Diamante		3.5	1999-2001		HB214x.618	D530		
Diamante		3.5	2003-2004		HB214x.618	D530		
Eclipse	GS	1.8	1990-1994		HB213x.626	D484		
Eclipse	GS	2.0	1990-1994		HB213x.626	D484		
Eclipse	GS	2.0	1995-1998		HB213x.626	D484	HB367x.585	D383
Eclipse	GS	2.4	2006-2008		HB435x.622	D866	HB367x.585	D383
Eclipse	GST	2.0	1995-1998		HB213x.626	D484	HB367x.585	D383
Eclipse	GSX	2.0	1990-1992		HB213x.626	D484		
Eclipse	GSX	2.0	1993-1994		HB214x.618	D530		
Eclipse	GSX	2.0	1995-1998		HB214x.618	D530	HB367x.585	D383
Eclipse	GT	3.0	2005-2005		HB435x.622	D866	HB367x.585	D383
Eclipse	GT	3.8	2006-2008		HB435x.622	D866	HB367x.585	D383
Eclipse	GTS	3.0	2003-2005		HB435x.622	D866	HB367x.585	D383
Eclipse	RS	2.0	1995-1998		HB213x.626	D484		
Eclipse	SE	2.4	2008-2008		HB435x.622	D866	HB367x.585	D383
Eclipse	SE	3.8	2008-2008		HB435x.622	D866	HB367x.585	D383
Eclipse	Spyder	2.4	1999-1999		HB213x.626	D484	HB367x.585	D383
Eclipse	Spyder	2.4	2001-2004		HB435x.622	D866		
Eclipse	Spyder	3.0	2001-2004		HB435x.622	D866	HB367x.585	D383
Eclipse	Spyder GS	2.4	1996-1998		HB213x.626	D484	HB367x.585	D383
Eclipse	Spyder GS	2.4	2005-2005		HB435x.622	D866		
Eclipse	Spyder GS	2.4	2007-2008		HB435x.622	D866	HB367x.585	D383
Eclipse	Spyder GST	2.0	1996-1998		HB213x.626	D484	HB367x.585	D383
Eclipse	Spyder GT	3.0	2005-2005		HB435x.622	D866	HB367x.585	D383
Eclipse	Spyder GT	3.8	2007-2008		HB435x.622	D866	HB367x.585	D383
Eclipse	Spyder GTS	3.0	2003-2005		HB435x.622	D866	HB367x.585	D383
Eclipse		1.8	1990-1994		HB213x.626	D484		
Eclipse		2.0	1996-1997		HB213x.626	D484	HB367x.585	D383
Eclipse		2.0	1999-1999		HB213x.626	D484	HB367x.585	D383
Eclipse		2.4	2000-2000		HB213x.626	D484		
Eclipse		2.4	2001-2004		HB435x.622	D866		
Eclipse		3.0	2000-2000		HB213x.626	D484	HB367x.585	D383
Eclipse		3.0	2001-2004		HB435x.622	D866	HB367x.585	D383
Expo	SP	2.4	1992-1993		HB213x.626	D484	HB367x.585	D383
Expo		2.4	1992-1995		HB213x.626	D484		
Expo LRV	Sport	1.8	1992-1992		HB213x.626	D484	HB367x.585	D383
Expo LRV	Sport	2.4	1993-1994		HB213x.626	D484	HB367x.585	D383
Expo LRV		1.8	1992-1994		HB213x.626	D484		
Expo LRV		2.4	1993-1994		HB213x.626	D484		
Galant	DE	2.4	2005-2006		HB435x.622	D866	HB367x.585	D383
Galant	DE	2.4	2008-2008		HB435x.622	D866	HB367x.585	D383
Galant	ES	2.0	1993-1993		HB213x.626	D484		
Galant	ES	2.4	1994-1998		HB213x.626	D484		

CODE Breakdown

HB 245 x .631

Insert Compound Code

Make/Model	Submodel	Engine (Liter)	Years	Note	FRONT		REAR	
					Hawk #	FMSI	Hawk #	FMSI
MITSUBISHI CONT.								
Galant	ES	2.4	2005-2006		HB435x.622	D866	HB367x.585	D383
Galant	ES	2.4	2008-2008		HB435x.622	D866	HB367x.585	D383
Galant	GS	2.0	1991-1992		HB213x.626	D484		
Galant	GS	2.4	1994-1994		HB213x.626	D484	HB367x.585	D383
Galant	GSR	2.0	1991-1992		HB213x.626	D484		
Galant	GSX	2.0	1991-1992		HB213x.626	D484		
Galant	GTS	3.8	2005-2006		HB435x.622	D866	HB367x.585	D383
Galant	GTS	3.8	2007-2007		HB435x.622	D866		
Galant	LS	2.0	1991-1993		HB213x.626	D484		
Galant	LS	2.4	1994-1998		HB213x.626	D484		
Galant	LS	3.8	2005-2006		HB435x.622	D866	HB367x.585	D383
Galant	Ralliart	3.8	2007-2008		HB435x.622	D866		
Galant	S	2.0	1993-1993		HB213x.626	D484		
Galant	S	2.4	1994-1996		HB213x.626	D484		
Galant	VR-4	2.0	1991-1992		HB214x.618	D530		
Galant		2.0	1991-1992		HB213x.626	D484		
Galant		2.4	1999-2000		HB214x.618	D530	HB367x.585	D383
Galant		2.4	2001-2004		HB435x.622	D866	HB367x.585	D383
Galant		3.0	1999-2000		HB214x.618	D530	HB367x.585	D383
Galant		3.0	2001-2003		HB435x.622	D866	HB367x.585	D383
Galant		3.8	2004-2004		HB435x.622	D866	HB367x.585	D383
Lancer	DE	2.0	2008-2008		HB435x.622	D866	HB457x.605	D1037
Lancer	ES	2.0	2005-2006		HB438x.606	D904		
Lancer	ES	2.0	2008-2008		HB435x.622	D866	HB457x.605	D1037
Lancer	Evolution	2.0	2003-2006		HB180x.560	D961	HB180x.640	D961
Lancer	Evolution	2.0	2003-2006		HB453x.585	D1001	HB180x.640	D961
Lancer	Evolution MR	2.0	2005-2006		HB180x.560	D961	HB180x.640	D961
Lancer	Evolution MR	2.0	2005-2006		HB453x.585	D1001	HB180x.640	D961
Lancer	Evolution RS	2.0	2005-2006		HB180x.560	D961	HB180x.640	D961
Lancer	Evolution RS	2.0	2005-2006		HB453x.585	D1001	HB180x.640	D961
Lancer	Evolution SE	2.0	2006-2006		HB180x.560	D961	HB180x.640	D961
Lancer	Evolution SE	2.0	2006-2006		HB453x.585	D1001	HB180x.640	D961
Lancer	GTS	2.0	2008-2008		HB435x.622	D866	HB457x.605	D1037
Lancer	OZ Rally	2.0	2005-2005		HB438x.606	D904	HB457x.605	D1037
Lancer	OZ Rally	2.0	2006-2006		HB438x.606	D904		
Lancer	Ralliart	2.4	2004-2004		HB435x.622	D866	HB457x.605	D1037
Lancer	SE	2.0	2006-2006		HB438x.606	D904		
Lancer	Sportback	2.4	2004-2004		HB435x.622	D866		
Lancer		2.0	2002-2004		HB438x.606	D904		
Mighty Max	LWB	2.4	1992-1992		HB404x.642	D349		
Mighty Max	LWB	2.6	1989-1989		HB404x.642	D349		
Mighty Max	SPX	2.6	1987-1989		HB404x.642	D349		
Mighty Max	SWB	2.0	1989-1989		HB404x.642	D349		
Mighty Max	SWB	2.4	1992-1992		HB404x.642	D349		
Mighty Max	SWB	2.4	1995-1995		HB404x.642	D349		
Mighty Max	SWB	2.6	1989-1989		HB404x.642	D349		
Mighty Max	SWB	3.0	1992-1992		HB404x.642	D349		
Mighty Max		2.0	1987-1989		HB404x.642	D349		
Mighty Max		2.4	1990-1994		HB404x.642	D349		
Mighty Max		2.6	1987-1989		HB404x.642	D349		
Mighty Max		3.0	1990-1994		HB404x.642	D349		
Mirage	DE	1.5	1997-1998		HB230x.575	D602		

RACE COMPOUND CODES

DTC-70 - U | DTC-05 - H | MT-4 - L | DR-97 - J
 DTC-60 - G | HT-14 - V | Blue 9012 - E | HP Plus - N
 DTC-30 - W | HT-10 - S | Black - M

STREET COMPOUND CODES

HPS Performance Street - F | SuperDuty - P
 Performance Ceramic - Z
 LTS Light Truck & SUV - Y

Make/ Model	Submodel	Engine		Note	FRONT		REAR	
		(Liter)	Years		Hawk #	FMSI	Hawk #	FMSI
MITSUBISHI CONT.								
Mirage	ES	1.5	1993-1995		HB230x.575	D602		
Mirage	ES	1.8	1993-1995		HB230x.575	D602		
Mirage	GS	1.6	1991-1992		HB230x.575	D602		
Mirage	LS	1.5	1991-1993		HB230x.575	D602		
Mirage	LS	1.8	1993-1998		HB230x.575	D602		
Mirage	S	1.5	1993-1996		HB230x.575	D602		
Mirage	VL	1.5	1991-1992		HB230x.575	D602		
Mirage		1.5	1991-1992		HB230x.575	D602		
Mirage		1.8	1999-1999		HB230x.575	D602		
Mirage		1.8	2000-2002		HB213x.626	D484		
Montero	LS	3.0	1989-1995		HB404x.642	D349		
Montero	RS	3.0	1991-1991		HB404x.642	D349		
Montero	Sport	2.6	1988-1988		HB404x.642	D349		
Montero	Sport	3.0	1989-1990		HB404x.642	D349		
Montero		3.5	1999-2002		HB214x.618	D530		
Montero		3.8	2003-2004		HB214x.618	D530		
Montero Sport		3.0	1999-2003		HB214x.618	D530		
Montero Sport		3.5	2000-2004		HB214x.618	D530		
Outlander	ES	3.0	2007-2008		HB435x.622	D866		
Outlander	Limited	2.4	2005-2006		HB214x.618	D530	HB457x.605	D1037
Outlander	LS	2.4	2005-2006		HB214x.618	D530	HB457x.605	D1037
Outlander	LS	3.0	2007-2008		HB435x.622	D866		
Outlander	SE	2.4	2006-2006		HB214x.618	D530	HB457x.605	D1037
Outlander	XLS	2.4	2005-2005		HB214x.618	D530	HB457x.605	D1037
Outlander	XLS	3.0	2007-2008		HB435x.622	D866		
Outlander		2.4	2003-2004		HB435x.622	D866		
Raider	Durocross	3.7	2006-2008		HB559x.695	D1084		
Raider	Durocross	4.7	2006-2006		HB559x.695	D1084		
Raider	LS	3.7	2006-2008		HB559x.695	D1084		
Raider	LS	4.7	2007-2008		HB559x.695	D1084		
Raider	SE	4.7	2007-2008		HB559x.695	D1084		
Raider	XLS	4.7	2006-2006		HB559x.695	D1084		
Van		2.4	1987-1990		HB404x.642	D349		
NISSAN								
810		2.4	1977-1980		HB169x.560	D57		
200SX	SE	1.6	1995-1998		HB236x.622	D668		
200SX	SE	2.0	1995-1995		HB236x.622	D668		
200SX	SE-R	2.0	1996-1998		HB236x.622	D668		
200SX		1.6	1995-1998		HB236x.622	D668		
200SX		2.0	1995-1995		HB236x.622	D668		
200SX		2.0	1998-1998		HB236x.622	D668		
200SX		3.0	1987-1988		HB475x.642	D266	HB262x.540	D429
240SX	LE	2.4	1991-1992	Non-ABS	HB231x.625	D422	HB262x.540	D429
240SX	LE	2.4	1991-1992	4-Wheel ABS	HB235x.665	D462	HB262x.540	D429
240SX	LE	2.4	1997-1997		HB235x.665	D462	HB262x.540	D429
240SX	SE	2.4	1989-1993	Non-ABS	HB231x.625	D422	HB262x.540	D429
240SX	SE	2.4	1989-1993	4-Wheel ABS	HB235x.665	D462	HB262x.540	D429
240SX	SE	2.4	1994-1996		HB231x.625	D422	HB262x.540	D429
240SX	SE	2.4	1997-1997		HB235x.665	D462	HB262x.540	D429
240SX		2.4	1991-1993		HB231x.625	D422	HB262x.540	D429
240SX		2.4	1995-1996		HB231x.625	D422	HB262x.540	D429
240SX		2.4	1997-1998		HB235x.665	D462	HB262x.540	D429

CODE Breakdown

HB 245 x .631

Insert Compound Code

Make/Model	Submodel	Engine (Liter)	Years	Note	FRONT		REAR	
					Hawk #	FMSI	Hawk #	FMSI
NISSAN CONT.								
240Z		2.4	1970-1973		HB169x.560	D57		
260Z	2+2	2.6	1974-1975		HB169x.560	D57		
260Z		2.6	1974-1975		HB169x.560	D57		
280Z	2+2	2.8	1975-1978		HB169x.560	D57		
280Z		2.8	1975-1978		HB169x.560	D57		
300ZX	2+2	3.0	1984-1987		HB475x.642	D266		
300ZX	2+2	3.0	1989-1996		HB178x.564	D460		
300ZX		3.0	1984-1989		HB475x.642	D266	HB262x.540	D429
300ZX		3.0	1989-1993		HB178x.564	D460	HB179x.630	D461
300ZX		3.0	1994-1996		HB178x.564	D460		
350Z	Enthusiast	3.5	2004-2008	w/o Brembo brakes. w/o 18 in. Wheels	HB387x.547	D888	HB370x.559	D905
350Z	Enthusiast	3.5	2004-2008	w/Brembo Brakes and 18 in. Wheels	HB545x.564	D960	HB180x.560	D961
350Z	Grand Touring	3.5	2004-2008	w/o Brembo brakes. w/o 18 in. Wheels	HB387x.547	D888	HB370x.559	D905
350Z	Grand Touring	3.5	2004-2008	w/Brembo Brakes and 18 in. Wheels	HB545x.564	D960	HB180x.560	D961
350Z	Touring	3.5	2004-2008	w/o Brembo brakes. w/o 18 in. Wheels	HB387x.547	D888	HB370x.559	D905
350Z	Touring	3.5	2004-2008	w/Brembo Brakes and 18 in. Wheels	HB545x.564	D960	HB180x.560	D961
350Z	Track	3.5	2004-2008	w/o Brembo brakes. w/o 18 in. Wheels	HB387x.547	D888	HB370x.559	D905
350Z	Track	3.5	2004-2008	w/Brembo Brakes and 18 in. Wheels	HB545x.564	D960	HB180x.560	D961
350Z		3.5	2003-2003		HB268x.665	D653	HB370x.559	D905
620 Pickup		2.0	1978-1979		HB169x.560	D57		
Altima	GLE	2.4	1993-1997		HB412x.665	D526	HB421x.622	D540
Altima	GXE	2.4	1993-1997		HB412x.665	D526	HB421x.622	D540
Altima	Hybrid	2.5	2007-2007		HB268x.665	D653		
Altima	Hybrid	2.5	2008-2008		HB268x.665	D653	HB600x.539	D1288
Altima	S	2.5	2006-2006		HB268x.665	D653	HB370x.559	D905
Altima	S	2.5	2008-2008		HB268x.665	D653	HB600x.539	D1288
Altima	SE	2.4	1993-1997		HB412x.665	D526	HB421x.622	D540
Altima	SE	3.5	2006-2006		HB268x.665	D653	HB370x.559	D905
Altima	SE	3.5	2008-2008		HB268x.665	D653	HB600x.539	D1288
Altima	SE-R	3.5	2006-2006		HB448x.610	D969	HB370x.559	D905
Altima	SL	2.5	2006-2006		HB268x.665	D653	HB370x.559	D905
Altima	SL	3.5	2006-2006		HB268x.665	D653	HB370x.559	D905
Altima	SL	3.5	2008-2008		HB268x.665	D653	HB600x.539	D1288
Altima	XE	2.4	1993-1997		HB412x.665	D526	HB421x.622	D540
Altima		2.4	1998-2001		HB268x.665	D653	HB421x.622	D540
Altima		2.5	2002-2006		HB268x.665	D653	HB370x.559	D905
Altima		2.5	2008-2008		HB268x.665	D653	HB600x.539	D1288
Altima		3.5	2002-2005		HB268x.665	D653	HB370x.559	D905
Armada	LE	5.6	2005-2006		HB567x.694	D1183	HB555x.678	D1041
Armada	SE	5.6	2005-2006		HB567x.694	D1183		
Armada	SE Off-Road	5.6	2005-2006		HB567x.694	D1183	HB555x.678	D1041
Axxess		2.4	1990-1990		HB235x.665	D462		
Frontier		2.4	2003-2004	4WD	HB488x.629	D830		
Frontier		3.3	2003-2004	4WD	HB488x.629	D830		
Maxima	GLE	3.0	1995-1998		HB412x.665	D526	HB421x.622	D540
Maxima	GXE	3.0	1992-1994		HB412x.665	D526		
Maxima	GXE	3.0	1995-1998		HB412x.665	D526	HB421x.622	D540
Maxima	SE	3.0	1992-1998		HB412x.665	D526	HB421x.622	D540
Maxima	SE	3.5	2005-2008		HB448x.610	D969	HB370x.559	D905
Maxima	SL	3.5	2005-2008		HB448x.610	D969	HB370x.559	D905
Maxima		3.0	1985-1988		HB475x.642	D266	HB262x.540	D429
Maxima		3.0	1989-1990		HB268x.665	D653	HB262x.540	D429

RACE COMPOUND CODES

DTC-70 - U	DTC-05 - H	MT-4 - L	DR-97 - J
DTC-60 - G	HT-14 - V	Blue 9012 - E	HP Plus - N
DTC-30 - W	HT-10 - S	Black - M	

STREET COMPOUND CODES

HPS Performance Street - F	SuperDuty - P
Performance Ceramic - Z	
LTS Light Truck & SUV - Y	

Make/ Model	Submodel	Engine		Note	FRONT		REAR	
		(Liter)	Years		Hawk #	FMSI	Hawk #	FMSI
NISSAN CONT.								
Maxima		3.0	2000-2001		HB268x.665	D653		
Maxima		3.5	2002-2003		HB268x.665	D653	HB378x.626	D1008
Maxima		3.5	2004-2004		HB448x.610	D969		
Murano	LE	3.5	2009-2009		HB448x.610	D969	HB370x.559	D905
Murano	S	3.5	2005-2007		HB448x.610	D969	HB370x.559	D905
Murano	S	3.5	2009-2009		HB448x.610	D969	HB370x.559	D905
Murano	SE	3.5	2005-2007		HB448x.610	D969	HB370x.559	D905
Murano	SL	3.5	2005-2007		HB448x.610	D969	HB370x.559	D905
Murano	SL	3.5	2009-2009		HB448x.610	D969	HB370x.559	D905
Murano		3.5	2003-2004		HB448x.610	D969	HB370x.559	D905
Pathfinder	Armada	5.6	2004-2004		HB567x.694	D1183	HB555x.678	D1041
Pathfinder	LE	3.0	1994-1995		HB402x.669	D333		
Pathfinder	LE	3.3	1996-1997		HB326x.646	D691		
Pathfinder	LE	4.0	2008-2008		HB387x.547	D888		
Pathfinder	LE	5.6	2008-2008		HB387x.547	D888		
Pathfinder	S	4.0	2008-2008		HB387x.547	D888		
Pathfinder	SE	3.0	1990-1995		HB402x.669	D333		
Pathfinder	SE	3.3	1996-1997		HB326x.646	D691		
Pathfinder	SE	4.0	2008-2008		HB387x.547	D888		
Pathfinder	SE	5.6	2008-2008		HB387x.547	D888		
Pathfinder	SE Off-Road	4.0	2008-2008		HB387x.547	D888		
Pathfinder	XE	3.0	1990-1995		HB402x.669	D333		
Pathfinder	XE	3.3	1996-1997		HB326x.646	D691		
Pathfinder		2.4	1987-1987		HB402x.669	D333		
Pathfinder		3.0	1987-1989		HB402x.669	D333		
Pathfinder		3.3	1998-2000		HB326x.646	D691		
Pathfinder		3.5	2001-2004		HB326x.646	D691		
Pickup D21	SE	2.4	1996-1997	4WD	HB402x.669	D333		
Pickup D21	SE	2.4	1996-1997	2WD	HB475x.642	D266		
Pickup D21	SE	3.0	1991-1994		HB402x.669	D333		
Pickup D21	SE	3.0	1995-1995	4WD	HB402x.669	D333		
Pickup D21	Short Bed XE	2.4	1995-1997		HB402x.669	D333		
Pickup D21	Short Bed XE	2.4	1996-1997		HB475x.642	D266		
Pickup D21	XE	2.4	1994-1997	4WD	HB402x.669	D333		
Pickup D21	XE	2.4	1996-1997	2WD	HB475x.642	D266		
Pickup D21	XE	3.0	1994-1995	4WD	HB402x.669	D333		
Pickup D21		2.4	1986-1993	4WD	HB402x.669	D333		
Pickup D21		2.4	1994-1995		HB402x.669	D333		
Pickup D21		2.4	1997-1997		HB402x.669	D333		
Pickup D21		3.0	1986-1994		HB402x.669	D333		
Pulsar NX		1.5	1984-1984		HB475x.642	D266		
Pulsar NX		1.6	1983-1986		HB475x.642	D266		
Quest	GXE	3.0	1993-1998		HB414x.622	D576		
Quest	S	3.5	2005-2008		HB326x.646	D691	HB370x.559	D905
Quest	SE	3.5	2005-2008		HB326x.646	D691	HB370x.559	D905
Quest	SL	3.5	2005-2008		HB326x.646	D691	HB370x.559	D905
Quest	XE	3.0	1993-1998		HB414x.622	D576		
Quest		3.3	1999-2002		HB414x.622	D576		
Quest		3.5	2004-2008		HB326x.646	D691	HB370x.559	D905
Sentra	CA	1.8	2002-2002		HB235x.665	D462		
Sentra	E	1.6	1996-1996		HB236x.622	D668		
Sentra	GLE	1.6	1995-1997		HB236x.622	D668		

CODE Breakdown

HB 245 x .631

Insert Compound Code

Make/Model	Submodel	Engine (Liter)	Years	Note	FRONT		REAR	
					Hawk #	FMSI	Hawk #	FMSI
NISSAN CONT.								
Sentra	GXE	1.6	1995-1997		HB236x.622	D668		
Sentra	GXE	1.8	2002-2003		HB235x.665	D462		
Sentra	Limited Edition	2.5	2003-2003		HB268x.665	D653	HB378x.626	D1008
Sentra	S	1.8	2005-2006		HB235x.665	D462		
Sentra	S	2.0	2007-2007		HB268x.665	D653		
Sentra	SE-R	2.5	2002-2006		HB268x.665	D653	HB378x.626	D1008
Sentra	SE-R	2.5	2007-2008		HB268x.665	D653		
Sentra	SE-R SPEC V	2.5	2003-2006		HB545x.564	D960	HB378x.626	D1008
Sentra	SE-R SPEC V	2.5	2007-2007		HB545x.564	D960		
Sentra	SE-R SPEC V	2.5	2008-2008		HB545x.564	D960	HB600x.539	D1288
Sentra	SL	2.0	2007-2007		HB268x.665	D653		
Sentra	XE	1.6	1995-1997		HB236x.622	D668		
Sentra	XE	1.8	2002-2003		HB235x.665	D462		
Sentra		1.6	1995-1995		HB236x.622	D668		
Sentra		1.6	1998-1999		HB236x.622	D668		
Sentra		1.8	2000-2001		HB235x.665	D462		
Sentra		1.8	2004-2004	Drum	HB235x.665	D462		
Sentra		1.8	2004-2004	Disc	HB268x.665	D653	HB378x.626	D1008
Sentra		1.8	2005-2006		HB235x.665	D462		
Sentra		2.0	2001-2001	Drum	HB235x.665	D462		
Sentra		2.0	2001-2001	Disc	HB268x.665	D653		
Sentra		2.0	2007-2008		HB268x.665	D653		
Sentra		2.5	2004-2004	Drum	HB235x.665	D462		
Sentra		2.5	2004-2004	Disc	HB268x.665	D653	HB378x.626	D1008
Stanza	GL	2.0	1984-1985		HB475x.642	D266		
Stanza	XE	2.0	1984-1985		HB475x.642	D266		
Stanza		2.0	1986-1988		HB475x.642	D266		
Stanza		2.0	1989-1989	Sedan (4 Door)	HB235x.665	D462		
Stanza		2.0	1989-1989	Sedan (4 Door)	HB475x.642	D266		
Stanza		2.4	1990-1992		HB235x.665	D462	HB262x.540	D429
Skyline	GT-R	2.6	1993-1993		HB181x.660	D639	HB180x.640	D961
Titan	LE	5.6	2005-2007		HB567x.694	D1183	HB555x.678	D1041
Titan	SE	5.6	2005-2007		HB567x.694	D1183	HB555x.678	D1041
Titan	XE	5.6	2005-2007		HB567x.694	D1183	HB555x.678	D1041
Titan		5.6	2004-2004		HB567x.694	D1183	HB555x.678	D1041
Versa	S	1.8	2007-2007		HB268x.665	D653		
Versa	S	1.8	2008-2008	Non-ABS	HB268x.665	D653		
Versa	SL	1.8	2007-2007		HB268x.665	D653		
Versa	SL	1.8	2008-2008	Non-ABS	HB268x.665	D653		
XTerra		2.4	2000-2004		HB488x.629	D830		
XTerra		2.4	2003-2003		HB402x.669	D333		
XTerra		3.3	2000-2004		HB488x.629	D830		
XTerra		3.3	2003-2003		HB402x.669	D333		
OLDSMOBILE								
98	Regency	3.0	1985-1985		HB396x.630	D215		
98	Regency	3.8	1985-1990		HB396x.630	D215		
98	Regency	3.8	1992-1993		HB129x.681	D505		
98	Regency	3.8	1994-1994		HB217x.681	D623		
98	Regency	4.1	1981-1983		HB103x.590	D313		
98	Regency	4.3	1985-1985		HB396x.630	D215		
98	Regency	5.0	1980-1984		HB103x.590	D313		
98	Regency	5.7	1973-1973		HB103x.590	D313		

RACE COMPOUND CODES

DTC-70 - U | DTC-05 - H | MT-4 - L | DR-97 - J
 DTC-60 - G | HT-14 - V | Blue 9012 - E | HP Plus - N
 DTC-30 - W | HT-10 - S | Black - M

STREET COMPOUND CODES

HPS Performance Street - F | SuperDuty - P
 Performance Ceramic - Z
 LTS Light Truck & SUV - Y

Make/Model	Submodel	Engine		Note	FRONT		REAR	
		(Liter)	Years		Hawk #	FMSI	Hawk #	FMSI
OLDSMOBILE CONT.								
98	Regency	5.7	1977-1984		HB103x.590	D313		
98	Regency	6.6	1975-1975		HB103x.590	D313		
98	Regency	6.6	1977-1979		HB103x.590	D313		
98	Regency	7.5	1973-1976		HB103x.590	D313		
98	Regency Brougham	3.8	1985-1990		HB396x.630	D215		
98	Regency Brougham	4.1	1982-1983		HB103x.590	D313		
98	Regency Brougham	4.3	1985-1985		HB396x.630	D215		
98	Regency Brougham	5.0	1982-1984		HB103x.590	D313		
98	Regency Brougham	5.7	1982-1984		HB103x.590	D313		
98	Regency Elite	3.8	1991-1993		HB129x.681	D505		
98	Regency Elite	3.8	1994-1996		HB217x.681	D623		
98	Regency Touring	3.8	1988-1990		HB396x.630	D215		
98	Regency Touring	3.8	1991-1993		HB129x.681	D505		
98		4.1	1981-1981		HB103x.590	D313		
98		5.0	1980-1981		HB103x.590	D313		
98		5.7	1972-1973		HB103x.590	D313		
98		5.7	1977-1981		HB103x.590	D313		
98		6.6	1975-1975		HB103x.590	D313		
98		6.6	1977-1979		HB103x.590	D313		
98		7.5	1968-1976		HB103x.590	D313		
442		5.7	1968-1970		HB103x.590	D313		
442		6.6	1968-1969		HB103x.590	D313		
442		7.5	1968-1971		HB103x.590	D313		
Achieva	S	2.3	1992-1995		HB390x.602	D506		
Achieva	S	3.1	1994-1995		HB390x.602	D506		
Achieva	S	3.3	1992-1993		HB390x.602	D506		
Achieva	SC	2.3	1994-1994		HB390x.602	D506		
Achieva	SC	2.4	1996-1997		HB390x.602	D506		
Achieva	SC	3.1	1994-1994		HB390x.602	D506		
Achieva	SC	3.1	1996-1997		HB390x.602	D506		
Achieva	SL	2.3	1992-1995		HB390x.602	D506		
Achieva	SL	2.4	1996-1997		HB390x.602	D506		
Achieva	SL	3.1	1994-1997		HB390x.602	D506		
Achieva	SL	3.3	1992-1993		HB390x.602	D506		
Achieva		2.4	1996-1996		HB390x.602	D506		
Achieva		3.1	1996-1996		HB390x.602	D506		
Alero		2.2	2002-2004		HB425x.661	D727	HB359x.543	D814
Alero		2.4	1999-2001		HB425x.661	D727	HB359x.543	D814
Alero		3.4	1999-2004		HB425x.661	D727	HB359x.543	D814
Aurora		3.5	2001-2002		HB360x.670	D699	HB359x.543	D814
Aurora		4.0	1995-1996		HB217x.681	D623	HB359x.543	D814
Aurora		4.0	1997-1999		HB360x.670	D699	HB359x.543	D814
Aurora		4.0	2001-2002		HB360x.670	D699	HB359x.543	D814
Bravada		4.2	2002-2004		HB382x.657	D882	HB383x.685	D883
Bravada		4.3	1991-1994		HB119x.594	D154		
Bravada		4.3	1996-1996		HB119x.594	D154		
Bravada		4.3	1997-2001		HB304x.598	D726	HB305x.610	D729
Calais	Supreme	2.5	1986-1987		HB400x.630	D159		
Calais	Supreme	3.0	1986-1987		HB400x.630	D159		
Calais		2.3	1987-1987		HB400x.630	D159		
Calais		2.5	1985-1987		HB400x.630	D159		
Calais		3.0	1985-1987		HB400x.630	D159		

CODE Breakdown

HB 245 x .631

Insert Compound Code

Make/Model	Submodel	Engine (Liter)	Years	Note	FRONT		REAR	
					Hawk #	FMSI	Hawk #	FMSI
OLDSMOBILE CONT.								
Cutlass	Brougham	3.8	1980-1981		HB119x.594	D154		
Cutlass	Brougham	4.3	1980-1981		HB119x.594	D154		
Cutlass	Brougham	5.0	1980-1980		HB119x.594	D154		
Cutlass	Brougham	5.7	1980-1981		HB119x.594	D154		
Cutlass	GLS	3.1	1997-1997		HB425x.661	D727		
Cutlass	LS	3.8	1980-1981		HB119x.594	D154		
Cutlass	LS	4.3	1980-1981		HB119x.594	D154		
Cutlass	LS	5.0	1980-1980		HB119x.594	D154		
Cutlass	LS	5.7	1980-1981		HB119x.594	D154		
Cutlass	S	3.8	1977-1977		HB103x.590	D313		
Cutlass	S	4.1	1971-1971		HB103x.590	D313		
Cutlass	S	4.1	1975-1976		HB103x.590	D313		
Cutlass	S	4.3	1975-1977		HB103x.590	D313		
Cutlass	S	5.7	1971-1977		HB103x.590	D313		
Cutlass	S	6.6	1977-1977		HB103x.590	D313		
Cutlass	S	7.5	1971-1976		HB103x.590	D313		
Cutlass	Salon	3.8	1978-1980		HB119x.594	D154		
Cutlass	Salon	3.8	1985-1987		HB119x.594	D154		
Cutlass	Salon	4.3	1975-1977		HB103x.590	D313		
Cutlass	Salon	4.3	1978-1980		HB119x.594	D154		
Cutlass	Salon	5.0	1978-1980		HB119x.594	D154		
Cutlass	Salon	5.0	1985-1987		HB119x.594	D154		
Cutlass	Salon	5.7	1975-1977		HB103x.590	D313		
Cutlass	Salon	5.7	1979-1980		HB119x.594	D154		
Cutlass	Salon	5.7	1985-1985		HB119x.594	D154		
Cutlass	Salon	6.6	1977-1977		HB103x.590	D313		
Cutlass	Salon	7.5	1975-1976		HB103x.590	D313		
Cutlass	Salon Brougham	3.8	1978-1980		HB119x.594	D154		
Cutlass	Salon Brougham	4.3	1978-1980		HB119x.594	D154		
Cutlass	Salon Brougham	5.0	1978-1980		HB119x.594	D154		
Cutlass	Salon Brougham	5.7	1980-1980		HB119x.594	D154		
Cutlass		3.1	1997-1999		HB425x.661	D727		
Cutlass		3.8	1977-1977		HB103x.590	D313		
Cutlass		3.8	1980-1980		HB119x.594	D154		
Cutlass		4.1	1968-1971		HB103x.590	D313		
Cutlass		4.1	1975-1975		HB103x.590	D313		
Cutlass		4.3	1975-1975		HB103x.590	D313		
Cutlass		4.3	1977-1977		HB103x.590	D313		
Cutlass		4.3	1980-1980		HB119x.594	D154		
Cutlass		5.0	1980-1980		HB119x.594	D154		
Cutlass		5.0	1985-1986		HB119x.594	D154		
Cutlass		5.7	1968-1975		HB103x.590	D313		
Cutlass		5.7	1977-1977		HB103x.590	D313		
Cutlass		5.7	1979-1980		HB119x.594	D154		
Cutlass		6.6	1968-1968		HB103x.590	D313		
Cutlass		6.6	1977-1977		HB103x.590	D313		
Cutlass		7.5	1970-1970		HB103x.590	D313		
Cutlass		7.5	1972-1975		HB103x.590	D313		
Cutlass Calais	International	2.3	1988-1989		HB400x.630	D159		
Cutlass Calais	International	2.3	1990-1990	w/Performance Package	HB390x.602	D506		
Cutlass Calais	International	2.3	1990-1990	w/o Performance Package	HB400x.630	D159		
Cutlass Calais	International	2.3	1991-1991		HB390x.602	D506		

RACE COMPOUND CODES

DTC-70 - U | DTC-05 - H | MT-4 - L | DR-97 - J
 DTC-60 - G | HT-14 - V | Blue 9012 - E | HP Plus - N
 DTC-30 - W | HT-10 - S | Black - M

STREET COMPOUND CODES

HPS Performance Street - F | SuperDuty - P
 Performance Ceramic - Z
 LTS Light Truck & SUV - Y

Make/ Model	Submodel	Engine (Liter)	Years	Note	FRONT		REAR	
					Hawk #	FMSI	Hawk #	FMSI
OLDSMOBILE CONT.								
Cutlass Calais	S	2.3	1989-1989		HB400x.630	D159		
Cutlass Calais	S	2.3	1990-1990	w/Performance Package	HB390x.602	D506		
Cutlass Calais	S	2.3	1990-1990	w/o Performance Package	HB400x.630	D159		
Cutlass Calais	S	2.3	1991-1991		HB390x.602	D506		
Cutlass Calais	S	2.5	1989-1989		HB400x.630	D159		
Cutlass Calais	S	2.5	1990-1990	w/Performance Package	HB390x.602	D506		
Cutlass Calais	S	2.5	1990-1990	w/o Performance Package	HB400x.630	D159		
Cutlass Calais	S	2.5	1991-1991		HB390x.602	D506		
Cutlass Calais	S	3.3	1989-1989		HB400x.630	D159		
Cutlass Calais	SL	2.3	1988-1989		HB400x.630	D159		
Cutlass Calais	SL	2.3	1990-1991		HB390x.602	D506		
Cutlass Calais	SL	2.5	1988-1989		HB400x.630	D159		
Cutlass Calais	SL	3.0	1988-1988		HB400x.630	D159		
Cutlass Calais	SL	3.3	1989-1989		HB400x.630	D159		
Cutlass Calais	SL	3.3	1990-1991		HB390x.602	D506		
Cutlass Calais		2.3	1988-1988		HB400x.630	D159		
Cutlass Calais		2.3	1991-1991		HB390x.602	D506		
Cutlass Calais		2.5	1988-1989		HB400x.630	D159		
Cutlass Calais		2.5	1990-1990	w/Performance Package	HB390x.602	D506		
Cutlass Calais		2.5	1990-1990	w/o Performance Package	HB400x.630	D159		
Cutlass Calais		2.5	1991-1991		HB390x.602	D506		
Cutlass Calais		3.0	1988-1988		HB400x.630	D159		
Cutlass Calais		3.8	1982-1984		HB119x.594	D154		
Cutlass Calais		3.8	1985-1985		HB400x.630	D159		
Cutlass Calais		4.3	1982-1984		HB119x.594	D154		
Cutlass Calais		5.0	1982-1984		HB119x.594	D154		
Cutlass Calais		5.0	1985-1985		HB400x.630	D159		
Cutlass Calais		5.7	1982-1984		HB119x.594	D154		
Cutlass Calais		5.7	1985-1985		HB400x.630	D159		
Cutlass Ciera	Brougham	2.5	1982-1982		HB400x.630	D159		
Cutlass Ciera	Brougham	2.5	1983-1988	w/Heavy Duty Brakes	HB396x.630	D215		
Cutlass Ciera	Brougham	2.5	1983-1988	w/Standard Brakes	HB400x.630	D159		
Cutlass Ciera	Brougham	2.8	1982-1982		HB400x.630	D159		
Cutlass Ciera	Brougham	2.8	1986-1988	w/Heavy Duty Brakes	HB396x.630	D215		
Cutlass Ciera	Brougham	2.8	1986-1988	w/Standard Brakes	HB400x.630	D159		
Cutlass Ciera	Brougham	3.0	1982-1982		HB400x.630	D159		
Cutlass Ciera	Brougham	3.0	1983-1985	w/Heavy Duty Brakes	HB396x.630	D215		
Cutlass Ciera	Brougham	3.0	1983-1985	w/Standard Brakes	HB400x.630	D159		
Cutlass Ciera	Brougham	3.8	1984-1985	w/Heavy Duty Brakes	HB396x.630	D215		
Cutlass Ciera	Brougham	3.8	1984-1985	w/Standard Brakes	HB400x.630	D159		
Cutlass Ciera	Brougham	3.8	1987-1988	w/Heavy Duty Brakes	HB396x.630	D215		
Cutlass Ciera	Brougham	3.8	1987-1988	w/Standard Brakes	HB400x.630	D159		
Cutlass Ciera	Brougham	4.3	1982-1982		HB400x.630	D159		
Cutlass Ciera	Brougham	4.3	1983-1985	w/Heavy Duty Brakes	HB396x.630	D215		
Cutlass Ciera	Brougham	4.3	1983-1985	w/Standard Brakes	HB400x.630	D159		
Cutlass Ciera	Cruiser	2.5	1984-1985	w/Heavy Duty Brakes	HB396x.630	D215		
Cutlass Ciera	Cruiser	2.5	1984-1985	w/Standard Brakes	HB400x.630	D159		
Cutlass Ciera	Cruiser	2.5	1987-1989	w/Heavy Duty Brakes	HB396x.630	D215		
Cutlass Ciera	Cruiser	2.5	1987-1989	w/Standard Brakes	HB400x.630	D159		
Cutlass Ciera	Cruiser	2.5	1990-1990		HB396x.630	D215		
Cutlass Ciera	Cruiser	2.8	1987-1989	w/Heavy Duty Brakes	HB396x.630	D215		
Cutlass Ciera	Cruiser	2.8	1987-1989	w/Standard Brakes	HB400x.630	D159		

CODE Breakdown

HB 245 x .631

Insert Compound Code

Make/Model	Submodel	Engine (Liter)	Years	Note	FRONT		REAR	
					Hawk #	FMSI	Hawk #	FMSI
OLDSMOBILE CONT.								
Cutlass Ciera	Cruiser	3.0	1984-1985	w/Heavy Duty Brakes	HB396x.630	D215		
Cutlass Ciera	Cruiser	3.0	1984-1985	w/Standard Brakes	HB400x.630	D159		
Cutlass Ciera	Cruiser	3.3	1989-1989	w/Heavy Duty Brakes	HB396x.630	D215		
Cutlass Ciera	Cruiser	3.3	1989-1989	w/Standard Brakes	HB400x.630	D159		
Cutlass Ciera	Cruiser	3.3	1990-1990		HB396x.630	D215		
Cutlass Ciera	Cruiser	3.8	1984-1985	w/Heavy Duty Brakes	HB396x.630	D215		
Cutlass Ciera	Cruiser	3.8	1984-1985	w/Standard Brakes	HB400x.630	D159		
Cutlass Ciera	Cruiser	3.8	1987-1988	w/Heavy Duty Brakes	HB396x.630	D215		
Cutlass Ciera	Cruiser	3.8	1987-1988	w/Standard Brakes	HB400x.630	D159		
Cutlass Ciera	Cruiser	4.3	1984-1985	w/Heavy Duty Brakes	HB396x.630	D215		
Cutlass Ciera	Cruiser	4.3	1984-1985	w/Standard Brakes	HB400x.630	D159		
Cutlass Ciera	Cruiser Brougham	2.5	1987-1988	w/Heavy Duty Brakes	HB396x.630	D215		
Cutlass Ciera	Cruiser Brougham	2.5	1987-1988	w/Standard Brakes	HB400x.630	D159		
Cutlass Ciera	Cruiser Brougham	2.8	1987-1988	w/Heavy Duty Brakes	HB396x.630	D215		
Cutlass Ciera	Cruiser Brougham	2.8	1987-1988	w/Standard Brakes	HB400x.630	D159		
Cutlass Ciera	Cruiser Brougham	3.8	1987-1988	w/Heavy Duty Brakes	HB396x.630	D215		
Cutlass Ciera	Cruiser Brougham	3.8	1987-1988	w/Standard Brakes	HB400x.630	D159		
Cutlass Ciera	Cruiser S	2.2	1993-1993		HB396x.630	D215		
Cutlass Ciera	Cruiser S	2.5	1991-1992		HB396x.630	D215		
Cutlass Ciera	Cruiser S	3.1	1994-1994		HB396x.630	D215		
Cutlass Ciera	Cruiser S	3.3	1991-1993		HB396x.630	D215		
Cutlass Ciera	Cruiser SL	2.5	1989-1989	w/Heavy Duty Brakes	HB396x.630	D215		
Cutlass Ciera	Cruiser SL	2.5	1989-1989	w/Standard Brakes	HB400x.630	D159		
Cutlass Ciera	Cruiser SL	2.8	1989-1989	w/Heavy Duty Brakes	HB396x.630	D215		
Cutlass Ciera	Cruiser SL	2.8	1989-1989	w/Standard Brakes	HB400x.630	D159		
Cutlass Ciera	Cruiser SL	3.3	1989-1989	w/Heavy Duty Brakes	HB396x.630	D215		
Cutlass Ciera	Cruiser SL	3.3	1989-1989	w/Standard Brakes	HB400x.630	D159		
Cutlass Ciera	Cruiser SL	3.3	1990-1993		HB396x.630	D215		
Cutlass Ciera	International	3.3	1989-1989	w/Heavy Duty Brakes	HB396x.630	D215		
Cutlass Ciera	International	3.3	1989-1989	w/Standard Brakes	HB400x.630	D159		
Cutlass Ciera	International	3.3	1990-1990		HB396x.630	D215		
Cutlass Ciera	International	3.8	1988-1988	w/Heavy Duty Brakes	HB396x.630	D215		
Cutlass Ciera	International	3.8	1988-1988	w/Standard Brakes	HB400x.630	D159		
Cutlass Ciera	LS	2.5	1983-1985	w/Heavy Duty Brakes	HB396x.630	D215		
Cutlass Ciera	LS	2.5	1983-1985	w/Standard Brakes	HB400x.630	D159		
Cutlass Ciera	LS	3.0	1983-1985	w/Heavy Duty Brakes	HB396x.630	D215		
Cutlass Ciera	LS	3.0	1983-1985	w/Standard Brakes	HB400x.630	D159		
Cutlass Ciera	LS	3.8	1984-1985	w/Heavy Duty Brakes	HB396x.630	D215		
Cutlass Ciera	LS	3.8	1984-1985	w/Standard Brakes	HB400x.630	D159		
Cutlass Ciera	LS	4.3	1983-1985	w/Heavy Duty Brakes	HB396x.630	D215		
Cutlass Ciera	LS	4.3	1983-1985	w/Standard Brakes	HB400x.630	D159		
Cutlass Ciera	S	2.2	1993-1994		HB396x.630	D215		
Cutlass Ciera	S	2.5	1987-1987	w/Heavy Duty Brakes	HB396x.630	D215		
Cutlass Ciera	S	2.5	1987-1987	w/Standard Brakes	HB400x.630	D159		
Cutlass Ciera	S	2.5	1990-1991		HB396x.630	D215		
Cutlass Ciera	S	2.8	1987-1987	w/Heavy Duty Brakes	HB396x.630	D215		
Cutlass Ciera	S	2.8	1987-1987	w/Standard Brakes	HB400x.630	D159		
Cutlass Ciera	S	3.1	1994-1994		HB396x.630	D215		
Cutlass Ciera	S	3.3	1990-1993		HB396x.630	D215		
Cutlass Ciera	S	3.8	1987-1987	w/Heavy Duty Brakes	HB396x.630	D215		
Cutlass Ciera	S	3.8	1987-1987	w/Standard Brakes	HB400x.630	D159		
Cutlass Ciera	SL	2.5	1987-1989	w/Heavy Duty Brakes	HB396x.630	D215		

RACE COMPOUND CODES

DTC-70 - U | DTC-05 - H | MT-4 - L | DR-97 - J
 DTC-60 - G | HT-14 - V | Blue 9012 - E | HP Plus - N
 DTC-30 - W | HT-10 - S | Black - M

STREET COMPOUND CODES

HPS Performance Street - F | SuperDuty - P
 Performance Ceramic - Z
 LTS Light Truck & SUV - Y

Make/ Model	Submodel	Engine		Note	FRONT		REAR	
		(Liter)	Years		Hawk #	FMSI	Hawk #	FMSI
OLDSMOBILE CONT.								
Cutlass Ciera	SL	2.5	1987-1989	w/Standard Brakes	HB400x.630	D159		
Cutlass Ciera	SL	2.8	1987-1989	w/Heavy Duty Brakes	HB396x.630	D215		
Cutlass Ciera	SL	2.8	1987-1989	w/Standard Brakes	HB400x.630	D159		
Cutlass Ciera	SL	3.1	1994-1994		HB396x.630	D215		
Cutlass Ciera	SL	3.3	1989-1989	w/Heavy Duty Brakes	HB396x.630	D215		
Cutlass Ciera	SL	3.3	1989-1989	w/Standard Brakes	HB400x.630	D159		
Cutlass Ciera	SL	3.3	1990-1993		HB396x.630	D215		
Cutlass Ciera	SL	3.8	1987-1988	w/Heavy Duty Brakes	HB396x.630	D215		
Cutlass Ciera	SL	3.8	1987-1988	w/Standard Brakes	HB400x.630	D159		
Cutlass Ciera	Special Edition	3.1	1994-1994		HB396x.630	D215		
Cutlass Ciera		2.5	1982-1982		HB400x.630	D159		
Cutlass Ciera		2.5	1983-1983	w/Heavy Duty Brakes	HB396x.630	D215		
Cutlass Ciera		2.5	1983-1983	w/Standard Brakes	HB400x.630	D159		
Cutlass Ciera		2.5	1985-1989	w/Heavy Duty Brakes	HB396x.630	D215		
Cutlass Ciera		2.5	1985-1989	w/Standard Brakes	HB400x.630	D159		
Cutlass Ciera		2.5	1990-1992		HB396x.630	D215		
Cutlass Ciera		2.8	1982-1982		HB400x.630	D159		
Cutlass Ciera		2.8	1986-1989	w/Heavy Duty Brakes	HB396x.630	D215		
Cutlass Ciera		2.8	1986-1989	w/Standard Brakes	HB400x.630	D159		
Cutlass Ciera		3.0	1982-1982		HB400x.630	D159		
Cutlass Ciera		3.0	1983-1983	w/Heavy Duty Brakes	HB396x.630	D215		
Cutlass Ciera		3.0	1983-1983	w/Standard Brakes	HB400x.630	D159		
Cutlass Ciera		3.0	1985-1985	w/Heavy Duty Brakes	HB396x.630	D215		
Cutlass Ciera		3.0	1985-1985	w/Standard Brakes	HB400x.630	D159		
Cutlass Ciera		3.3	1989-1989	w/Heavy Duty Brakes	HB396x.630	D215		
Cutlass Ciera		3.3	1989-1989	w/Standard Brakes	HB400x.630	D159		
Cutlass Ciera		3.3	1990-1992		HB396x.630	D215		
Cutlass Ciera		3.8	1985-1988	w/Heavy Duty Brakes	HB396x.630	D215		
Cutlass Ciera		3.8	1985-1988	w/Standard Brakes	HB400x.630	D159		
Cutlass Ciera		4.3	1982-1982		HB400x.630	D159		
Cutlass Supreme	Brougham	3.8	1977-1977		HB103x.590	D313		
Cutlass Supreme	Brougham	3.8	1978-1987		HB119x.594	D154		
Cutlass Supreme	Brougham	4.1	1976-1976		HB103x.590	D313		
Cutlass Supreme	Brougham	4.3	1976-1977		HB103x.590	D313		
Cutlass Supreme	Brougham	4.3	1978-1984		HB119x.594	D154		
Cutlass Supreme	Brougham	5.0	1978-1980		HB119x.594	D154		
Cutlass Supreme	Brougham	5.0	1982-1987		HB119x.594	D154		
Cutlass Supreme	Brougham	5.7	1976-1977		HB103x.590	D313		
Cutlass Supreme	Brougham	5.7	1979-1985		HB119x.594	D154		
Cutlass Supreme	Brougham	6.6	1977-1977		HB103x.590	D313		
Cutlass Supreme	Brougham	7.5	1976-1976		HB103x.590	D313		
Cutlass Supreme	Classic	5.0	1988-1988		HB119x.594	D154		
Cutlass Supreme	Classic Brougham	5.0	1988-1988		HB119x.594	D154		
Cutlass Supreme	Cruiser	5.7	1974-1975		HB103x.590	D313		
Cutlass Supreme	Cruiser	7.5	1974-1975		HB103x.590	D313		
Cutlass Supreme	International	2.3	1990-1990		HB232x.681	D376	HB405x.543	D377
Cutlass Supreme	International	2.8	1988-1989		HB232x.681	D376	HB405x.543	D377
Cutlass Supreme	International	3.1	1989-1993		HB232x.681	D376	HB405x.543	D377
Cutlass Supreme	International	3.4	1991-1993		HB232x.681	D376	HB405x.543	D377
Cutlass Supreme	S	3.1	1992-1993		HB232x.681	D376	HB405x.543	D377
Cutlass Supreme	S	3.1	1994-1994		HB232x.681	D376	HB359x.543	D814
Cutlass Supreme	S	3.4	1992-1993		HB232x.681	D376	HB405x.543	D377

CODE Breakdown

HB 245 x .631

Insert Compound Code

Make/Model	Submodel	Engine (Liter)	Years	Note	FRONT		REAR	
					Hawk #	FMSI	Hawk #	FMSI
OLDSMOBILE CONT.								
Cutlass Supreme	S	3.4	1994-1994		HB232x.681	D376	HB359x.543	D814
Cutlass Supreme	SL	2.8	1989-1989		HB232x.681	D376	HB405x.543	D377
Cutlass Supreme	SL	3.1	1989-1991		HB232x.681	D376	HB405x.543	D377
Cutlass Supreme	SL	3.1	1995-1997		HB232x.681	D376	HB359x.543	D814
Cutlass Supreme	SL	3.4	1991-1991		HB232x.681	D376	HB405x.543	D377
Cutlass Supreme	SL	3.4	1995-1996		HB232x.681	D376	HB359x.543	D814
Cutlass Supreme		2.3	1990-1991		HB232x.681	D376	HB405x.543	D377
Cutlass Supreme		2.8	1988-1989		HB232x.681	D376	HB405x.543	D377
Cutlass Supreme		3.1	1989-1993		HB232x.681	D376	HB405x.543	D377
Cutlass Supreme		3.1	1994-1995		HB232x.681	D376	HB359x.543	D814
Cutlass Supreme		3.1	1997-1997		HB232x.681	D376	HB359x.543	D814
Cutlass Supreme		3.4	1991-1991		HB232x.681	D376	HB405x.543	D377
Cutlass Supreme		3.4	1993-1993		HB232x.681	D376	HB405x.543	D377
Cutlass Supreme		3.4	1994-1995		HB232x.681	D376	HB359x.543	D814
Cutlass Supreme		3.8	1977-1977		HB103x.590	D313		
Cutlass Supreme		3.8	1978-1982		HB119x.594	D154		
Cutlass Supreme		3.8	1984-1987		HB119x.594	D154		
Cutlass Supreme		4.1	1975-1976		HB103x.590	D313		
Cutlass Supreme		4.3	1975-1977		HB103x.590	D313		
Cutlass Supreme		4.3	1978-1984		HB119x.594	D154		
Cutlass Supreme		5.0	1978-1980		HB119x.594	D154		
Cutlass Supreme		5.0	1982-1987		HB119x.594	D154		
Cutlass Supreme		5.7	1971-1977		HB103x.590	D313		
Cutlass Supreme		5.7	1978-1985		HB119x.594	D154		
Cutlass Supreme		6.6	1977-1977		HB103x.590	D313		
Cutlass Supreme		7.5	1971-1976		HB103x.590	D313		
Delmont 88		5.7	1968-1968		HB103x.590	D313		
Delta 88	Custom	5.7	1968-1970		HB103x.590	D313		
Delta 88	Custom	7.5	1968-1971		HB103x.590	D313		
Delta 88	Royale	3.0	1986-1986		HB396x.630	D215		
Delta 88	Royale	3.8	1977-1985		HB103x.590	D313		
Delta 88	Royale	3.8	1986-1991		HB396x.630	D215		
Delta 88	Royale	3.8	1992-1993		HB129x.681	D505		
Delta 88	Royale	3.8	1994-1998		HB217x.681	D623		
Delta 88	Royale	4.3	1977-1982		HB103x.590	D313		
Delta 88	Royale	4.9	1979-1979		HB103x.590	D313		
Delta 88	Royale	5.0	1980-1985		HB103x.590	D313		
Delta 88	Royale	5.7	1970-1970		HB103x.590	D313		
Delta 88	Royale	5.7	1972-1985		HB103x.590	D313		
Delta 88	Royale	6.6	1975-1975		HB103x.590	D313		
Delta 88	Royale	6.6	1977-1979		HB103x.590	D313		
Delta 88	Royale	7.5	1970-1976		HB103x.590	D313		
Delta 88	Royale Brougham	3.0	1986-1986		HB396x.630	D215		
Delta 88	Royale Brougham	3.8	1980-1985		HB103x.590	D313		
Delta 88	Royale Brougham	3.8	1986-1991		HB396x.630	D215		
Delta 88	Royale Brougham	4.3	1980-1982		HB103x.590	D313		
Delta 88	Royale Brougham	5.0	1980-1985		HB103x.590	D313		
Delta 88	Royale Brougham	5.7	1980-1985		HB103x.590	D313		
Delta 88	Royale Brougham LS	3.8	1984-1984		HB103x.590	D313		
Delta 88	Royale Brougham LS	5.0	1984-1985		HB103x.590	D313		
Delta 88	Royale Brougham LS	5.7	1984-1985		HB103x.590	D313		
Delta 88	Royale LS	3.8	1992-1993		HB129x.681	D505		

RACE COMPOUND CODES

DTC-70 - U | DTC-05 - H | MT-4 - L | DR-97 - J
 DTC-60 - G | HT-14 - V | Blue 9012 - E | HP Plus - N
 DTC-30 - W | HT-10 - S | Black - M

STREET COMPOUND CODES

HPS Performance Street - F | SuperDuty - P
 Performance Ceramic - Z
 LTS Light Truck & SUV - Y

Make/ Model	Submodel	Engine		Note	FRONT		REAR	
		(Liter)	Years		Hawk #	FMSI	Hawk #	FMSI
OLDSMOBILE CONT.								
Delta 88	Royale LS	3.8	1994-1998		HB217x.681	D623		
Delta 88	Royale LSS	3.8	1995-1995		HB217x.681	D623		
Delta 88		3.8	1977-1983		HB103x.590	D313		
Delta 88		3.8	1999-1999		HB217x.681	D623		
Delta 88		4.3	1977-1982		HB103x.590	D313		
Delta 88		4.9	1979-1979		HB103x.590	D313		
Delta 88		5.0	1980-1983		HB103x.590	D313		
Delta 88		5.7	1968-1983		HB103x.590	D313		
Delta 88		6.6	1975-1975		HB103x.590	D313		
Delta 88		6.6	1977-1979		HB103x.590	D313		
Delta 88		7.5	1968-1976		HB103x.590	D313		
F85		4.1	1968-1971		HB103x.590	D313		
F85		5.7	1968-1972		HB103x.590	D313		
F85		7.5	1970-1970		HB103x.590	D313		
F85		7.5	1972-1972		HB103x.590	D313		
Firenza	GT	2.8	1986-1987		HB400x.630	D159		
Firenza	LC	1.8	1986-1986		HB400x.630	D159		
Firenza	LC	2.0	1986-1987		HB400x.630	D159		
Firenza	LX	1.8	1982-1986		HB400x.630	D159		
Firenza	LX	2.0	1983-1987		HB400x.630	D159		
Firenza	LX	2.8	1985-1985		HB400x.630	D159		
Firenza	S	1.8	1982-1986		HB400x.630	D159		
Firenza	S	2.0	1983-1987		HB400x.630	D159		
Firenza	S	2.8	1985-1985		HB400x.630	D159		
Firenza	SX	1.8	1982-1985		HB400x.630	D159		
Firenza	SX	2.0	1983-1985		HB400x.630	D159		
Firenza	SX	2.8	1985-1985		HB400x.630	D159		
Firenza		1.8	1982-1986		HB400x.630	D159		
Firenza		2.0	1983-1988		HB400x.630	D159		
Firenza		2.8	1985-1985		HB400x.630	D159		
Intrigue		3.5	1999-2002		HB360x.670	D699	HB359x.543	D814
Intrigue		3.8	1998-1999		HB360x.670	D699	HB359x.543	D814
LSS		3.8	1997-1999		HB217x.681	D623		
Omega	Brougham	2.5	1980-1984		HB400x.630	D159		
Omega	Brougham	2.8	1980-1984		HB400x.630	D159		
Omega	Brougham	3.8	1977-1979		HB103x.590	D313		
Omega	Brougham	4.1	1976-1976		HB103x.590	D313		
Omega	Brougham	4.3	1976-1977		HB103x.590	D313		
Omega	Brougham	5.0	1977-1979		HB103x.590	D313		
Omega	Brougham	5.7	1976-1979		HB103x.590	D313		
Omega	F85	3.8	1977-1977		HB103x.590	D313		
Omega	F85	4.1	1976-1976		HB103x.590	D313		
Omega	F85	4.3	1976-1977		HB103x.590	D313		
Omega	F85	5.0	1977-1977		HB103x.590	D313		
Omega	F85	5.7	1976-1977		HB103x.590	D313		
Omega	Salon	4.1	1975-1975		HB103x.590	D313		
Omega	Salon	4.3	1975-1975		HB103x.590	D313		
Omega	Salon	5.7	1975-1975		HB103x.590	D313		
Omega		2.5	1980-1984		HB400x.630	D159		
Omega		2.8	1980-1984		HB400x.630	D159		
Omega		3.8	1977-1979		HB103x.590	D313		
Omega		4.1	1973-1976		HB103x.590	D313		

CODE Breakdown

HB 245 x .631

Insert Compound Code

Make/Model	Submodel	Engine (Liter)	Years	Note	FRONT		REAR	
					Hawk #	FMSI	Hawk #	FMSI
OLDSMOBILE CONT.								
Omega		4.3	1975-1977		HB103x.590	D313		
Omega		5.0	1977-1979		HB103x.590	D313		
Omega		5.7	1973-1979		HB103x.590	D313		
Regency		3.8	1997-1998		HB217x.681	D623		
Silhouette		3.1	1990-1991		HB396x.630	D215		
Silhouette		3.1	1992-1993		HB129x.681	D505		
Silhouette		3.1	1994-1994		HB217x.681	D623		
Silhouette		3.4	1996-1996		HB217x.681	D623		
Silhouette		3.4	1997-2001		HB360x.670	D699		
Silhouette		3.4	2002-2003	Drum	HB360x.670	D699		
Silhouette		3.4	2004-2004		HB360x.670	D699		
Silhouette		3.8	1992-1993		HB129x.681	D505		
Silhouette		3.8	1994-1995		HB217x.681	D623		
Toronado	Brougham	4.1	1981-1984		HB119x.594	D154	HB119x.594	D154
Toronado	Brougham	5.0	1980-1985		HB119x.594	D154	HB119x.594	D154
Toronado	Brougham	5.7	1979-1985		HB119x.594	D154	HB119x.594	D154
Toronado	Brougham	6.6	1977-1978		HB103x.590	D313		
Toronado	Brougham	7.5	1975-1976		HB103x.590	D313		
Toronado	XSR	5.7	1977-1977		HB103x.590	D313		
Toronado	XSR	6.6	1977-1977		HB103x.590	D313		
Toronado		4.1	1984-1984		HB119x.594	D154	HB119x.594	D154
Toronado		5.0	1980-1981		HB119x.594	D154	HB119x.594	D154
Toronado		5.0	1984-1985		HB119x.594	D154	HB119x.594	D154
Toronado		5.7	1979-1981		HB119x.594	D154	HB119x.594	D154
Toronado		5.7	1984-1985		HB119x.594	D154	HB119x.594	D154
Toronado		6.6	1978-1978		HB103x.590	D313		
Toronado		7.5	1968-1976		HB103x.590	D313		
Vista Cruiser		5.7	1968-1977		HB103x.590	D313		
Vista Cruiser		6.6	1968-1969		HB103x.590	D313		
Vista Cruiser		6.6	1977-1977		HB103x.590	D313		
Vista Cruiser		7.5	1970-1976		HB103x.590	D313		
OPEL								
1900	Rallye	1.9	1971-1972		HB172x.595	D31		
1900		1.9	1973-1974		HB172x.595	D31		
Manta		1.9	1971-1974		HB172x.595	D31		
Manta		1.9	1975-1975		HB180x.560	D961		
PEUGEOT								
405	DL	1.9	1989-1989		HB195x.640	D278	HB364x.642	D340
405	Mi16	1.9	1989-1989		HB195x.640	D278	HB364x.642	D340
405	S	1.9	1989-1989		HB195x.640	D278	HB364x.642	D340
504		2.0	1979-1979		HB199x.702	D443		
504		2.3	1979-1982		HB199x.702	D443		
505	DL	2.2	1988-1989		HB199x.702	D443		
505	GL	2.0	1984-1986		HB199x.702	D443		
505	GL	2.2	1986-1987		HB199x.702	D443		
505	GL	2.3	1984-1985		HB199x.702	D443		
505	GL	2.5	1986-1986		HB199x.702	D443		
505	GLS	2.2	1987-1988		HB199x.702	D443		
505	GLS	2.5	1987-1987		HB199x.702	D443		
505	GLX	2.8	1988-1988		HB199x.702	D443		
505	Liberte	2.0	1987-1987		HB199x.702	D443		

RACE COMPOUND CODES

DTC-70 - U | DTC-05 - H | MT-4 - L | DR-97 - J
 DTC-60 - G | HT-14 - V | Blue 9012 - E | HP Plus - N
 DTC-30 - W | HT-10 - S | Black - M

STREET COMPOUND CODES

HPS Performance Street - F | SuperDuty - P
 Performance Ceramic - Z
 LTS Light Truck & SUV - Y

Make/ Model	Submodel	Engine		Note	FRONT		REAR	
		(Liter)	Years		Hawk #	FMSI	Hawk #	FMSI
PEUGEOT CONT.								
505	S	2.0	1986-1986		HB199x.702	D443		
505	S	2.2	1987-1989		HB199x.702	D443		
505	S	2.3	1986-1986		HB199x.702	D443		
505	S	2.5	1986-1986		HB199x.702	D443		
505	S	2.8	1989-1989		HB199x.702	D443		
505	STi	2.0	1986-1986		HB199x.702	D443		
505	STi	2.2	1987-1988		HB199x.702	D443		
505	STi	2.8	1987-1987		HB199x.702	D443		
505	STX	2.8	1987-1989		HB199x.702	D443		
505	SW8	2.2	1989-1989		HB199x.702	D443		
505	Turbo	2.2	1989-1989		HB199x.702	D443		
505		2.0	1980-1985		HB199x.702	D443		
505		2.2	1985-1987		HB199x.702	D443		
505		2.3	1980-1985		HB199x.702	D443		
505		2.5	1985-1987		HB199x.702	D443		
604		2.3	1982-1982		HB199x.702	D443		
604		2.7	1977-1978		HB199x.702	D443		
604		2.8	1979-1980		HB199x.702	D443		
PLYMOUTH								
Acclaim	LE	2.5	1991-1991	Disc	HB410x.721	D522	HB176x.614	D641
Acclaim	LE	2.5	1991-1991	Drum	HB411x.717	D521		
Acclaim	LE	3.0	1991-1991	Disc	HB410x.721	D522	HB176x.614	D641
Acclaim	LE	3.0	1991-1991	Drum	HB411x.717	D521		
Acclaim	LX	3.0	1991-1991	Disc	HB410x.721	D522	HB176x.614	D641
Acclaim	LX	3.0	1991-1991	Drum	HB411x.717	D521		
Acclaim		2.5	1991-1994	Disc	HB410x.721	D522	HB176x.614	D641
Acclaim		2.5	1991-1994	Drum	HB411x.717	D521		
Acclaim		2.5	1995-1995		HB411x.717	D521		
Acclaim		3.0	1991-1994	Disc	HB410x.721	D522	HB176x.614	D641
Acclaim		3.0	1991-1994	Drum	HB411x.717	D521		
Acclaim		3.0	1995-1995		HB411x.717	D521		
Breeze		2.0	1996-2000		HB233x.635	D650		
Breeze		2.4	1997-2000		HB233x.635	D650		
Colt	GL	1.5	1991-1994		HB230x.575	D602		
Colt	GL	1.8	1993-1994		HB230x.575	D602		
Colt	Vista	1.8	1992-1994		HB213x.626	D484		
Colt	Vista	2.4	1992-1994		HB213x.626	D484		
Colt	Vista SE	1.8	1992-1992		HB213x.626	D484		
Colt	Vista SE	2.4	1992-1994		HB213x.626	D484		
Colt		1.5	1991-1994		HB230x.575	D602		
Colt		1.8	1992-1994		HB230x.575	D602		
Colt		2.4	1993-1994		HB230x.575	D602		
Grand Voyager	LE	3.0	1993-1993		HB410x.721	D522		
Grand Voyager	LE	3.3	1991-1994		HB410x.721	D522		
Grand Voyager	LE	3.8	1994-1994		HB410x.721	D522		
Grand Voyager	SE	2.4	1996-1997		HB177x.710	D642		
Grand Voyager	SE	3.0	1992-1993		HB410x.721	D522		
Grand Voyager	SE	3.0	1996-1997		HB177x.710	D642		
Grand Voyager	SE	3.3	1991-1994		HB410x.721	D522		
Grand Voyager	SE	3.3	1996-1997		HB177x.710	D642		
Grand Voyager		2.4	1996-1997		HB177x.710	D642		
Grand Voyager		3.0	1992-1994		HB410x.721	D522		

CODE Breakdown

HB 245 x .631

Insert Compound Code

Make/Model	Submodel	Engine (Liter)	Years	Note	FRONT		REAR	
					Hawk #	FMSI	Hawk #	FMSI
PLYMOUTH CONT.								
Grand Voyager		3.0	1996-2000		HB177x.710	D642		
Grand Voyager		3.3	1997-2000		HB177x.710	D642		
Grand Voyager		3.8	1999-1999		HB177x.710	D642		
Laser	RS	1.8	1990-1990		HB213x.626	D484		
Laser	RS	2.0	1990-1992		HB213x.626	D484		
Laser	RS	2.0	1993-1994		HB214x.618	D530		
Laser		1.8	1990-1992		HB213x.626	D484		
Laser		1.8	1993-1994		HB214x.618	D530		
Neon	Highline	2.0	1995-1997		HB177x.630	D642	HB176x.614	D641
Neon	Sport	2.0	1995-1996		HB177x.630	D642	HB176x.614	D641
Neon		2.0	1995-1999		HB177x.630	D642	HB176x.614	D641
Prowler		3.5	1997-1997		HB260x.670	D730	HB260x.670	D730
Prowler		3.5	1999-2001		HB260x.670	D730	HB260x.670	D730
Sundance	America	2.2	1991-1992		HB411x.717	D521		
Sundance	America	2.5	1992-1992		HB411x.717	D521		
Sundance	Duster	2.5	1992-1994		HB411x.717	D521		
Sundance	Duster	3.0	1992-1994		HB411x.717	D521		
Sundance	RS	2.5	1991-1991		HB411x.717	D521		
Sundance		2.2	1991-1994		HB411x.717	D521		
Sundance		2.5	1991-1994		HB411x.717	D521		
Valiant		3.2	1971-1972		HB471x.510	D11		
Valiant		3.7	1971-1972		HB471x.510	D11		
Valiant		5.2	1971-1972		HB471x.510	D11		
Voyager	LE	2.5	1991-1991	15 in. Wheel	HB410x.721	D522		
Voyager	LE	2.5	1991-1991	14 in. Wheel	HB411x.717	D521		
Voyager	LE	3.0	1991-1994	15 in. Wheel	HB410x.721	D522		
Voyager	LE	3.0	1991-1994	14 in. Wheel	HB411x.717	D521		
Voyager	LE	3.0	1995-1995		HB411x.717	D521		
Voyager	LE	3.3	1991-1994	15 in. Wheel	HB410x.721	D522		
Voyager	LE	3.3	1991-1994	14 in. Wheel	HB411x.717	D521		
Voyager	LE	3.3	1995-1995		HB411x.717	D521		
Voyager	LX	3.0	1994-1994	15 in. Wheel	HB410x.721	D522		
Voyager	LX	3.0	1994-1994	14 in. Wheel	HB411x.717	D521		
Voyager	LX	3.3	1994-1994	15 in. Wheel	HB410x.721	D522		
Voyager	LX	3.3	1994-1994	14 in. Wheel	HB411x.717	D521		
Voyager	SE	2.4	1996-1997		HB177x.710	D642		
Voyager	SE	2.5	1991-1993	15 in. Wheel	HB410x.721	D522		
Voyager	SE	2.5	1991-1993	14 in. Wheel	HB411x.717	D521		
Voyager	SE	3.0	1991-1994	15 in. Wheel	HB410x.721	D522		
Voyager	SE	3.0	1991-1994	14 in. Wheel	HB411x.717	D521		
Voyager	SE	3.0	1995-1995		HB411x.717	D521		
Voyager	SE	3.0	1996-1997		HB177x.710	D642		
Voyager	SE	3.3	1991-1994	15 in. Wheel	HB410x.721	D522		
Voyager	SE	3.3	1991-1994	14 in. Wheel	HB411x.717	D521		
Voyager	SE	3.3	1995-1995		HB411x.717	D521		
Voyager	SE	3.3	1996-1997		HB177x.710	D642		
Voyager		2.4	1996-2000		HB177x.710	D642		
Voyager		2.5	1991-1994	15 in. Wheel	HB410x.721	D522		
Voyager		2.5	1991-1994	14 in. Wheel	HB411x.717	D521		
Voyager		2.5	1995-1995		HB411x.717	D521		
Voyager		3.0	1991-1994	15 in. Wheel	HB410x.721	D522		
Voyager		3.0	1991-1994	14 in. Wheel	HB411x.717	D521		

RACE COMPOUND CODES

DTC-70 - U	DTC-05 - H	MT-4 - L	DR-97 - J
DTC-60 - G	HT-14 - V	Blue 9012 - E	HP Plus - N
DTC-30 - W	HT-10 - S	Black - M	

STREET COMPOUND CODES

HPS Performance Street - F	SuperDuty - P
Performance Ceramic - Z	
LTS Light Truck & SUV - Y	

Make/Model	Submodel	Engine		Note	FRONT		REAR	
		(Liter)	Years		Hawk #	FMSI	Hawk #	FMSI
PLYMOUTH CONT.								
Voyager		3.0	1995-1995		HB411x.717	D521		
Voyager		3.0	1996-2000		HB177x.710	D642		
Voyager		3.3	1994-1994	15 in. Wheel	HB410x.721	D522		
Voyager		3.3	1994-1994	14 in. Wheel	HB411x.717	D521		
Voyager		3.3	1995-1995		HB411x.717	D521		
Voyager		3.3	1997-2000		HB177x.710	D642		
Voyager		3.8	1999-1999		HB177x.710	D642		
Voyager			1994-1994	15 in. Wheel	HB410x.721	D522		
Voyager			1994-1994	14 in. Wheel	HB411x.717	D521		
Voyager			1995-1995		HB411x.717	D521		
Voyager			1998-1999		HB177x.710	D642		
PONTIAC								
6000	LE	2.5	1982-1982		HB400x.630	D159		
6000	LE	2.5	1983-1989	w/Heavy Duty Brakes	HB396x.630	D215		
6000	LE	2.5	1983-1989	w/Standard Brakes	HB400x.630	D159		
6000	LE	2.5	1990-1991		HB396x.630	D215		
6000	LE	2.8	1982-1982		HB400x.630	D159		
6000	LE	2.8	1983-1989	w/Heavy Duty Brakes	HB396x.630	D215		
6000	LE	2.8	1983-1989	w/Standard Brakes	HB400x.630	D159		
6000	LE	3.1	1990-1991		HB396x.630	D215		
6000	LE	4.3	1982-1982		HB400x.630	D159		
6000	LE	4.3	1983-1985	w/Heavy Duty Brakes	HB396x.630	D215		
6000	LE	4.3	1983-1985	w/Standard Brakes	HB400x.630	D159		
6000	SE	2.8	1986-1989	w/Heavy Duty Brakes	HB396x.630	D215		
6000	SE	2.8	1986-1989	w/Standard Brakes	HB400x.630	D159		
6000	SE	3.1	1990-1991		HB396x.630	D215		
6000	STE	2.8	1983-1988		HB396x.630	D215		
6000	STE	3.1	1988-1989		HB396x.630	D215		
6000		2.5	1982-1982		HB400x.630	D159		
6000		2.5	1983-1989	w/Heavy Duty Brakes	HB396x.630	D215		
6000		2.5	1983-1989	w/Standard Brakes	HB400x.630	D159		
6000		2.8	1982-1982		HB400x.630	D159		
6000		2.8	1983-1988	w/Heavy Duty Brakes	HB396x.630	D215		
6000		2.8	1983-1988	w/Standard Brakes	HB400x.630	D159		
6000		4.3	1982-1982		HB400x.630	D159		
6000		4.3	1983-1985	w/Heavy Duty Brakes	HB396x.630	D215		
6000		4.3	1983-1985	w/Standard Brakes	HB400x.630	D159		
Aztek	GT	3.4	2001-2001		HB373x.689	D844	HB359x.543	D814
Aztek	Rally	3.4	2004-2004		HB373x.689	D844	HB359x.543	D814
Aztek		3.4	2001-2005		HB373x.689	D844	HB359x.543	D814
Bonneville	Brougham	3.8	1981-1981		HB103x.590	D313		
Bonneville	Brougham	3.8	1982-1986		HB119x.594	D154		
Bonneville	Brougham	4.1	1982-1982		HB119x.594	D154		
Bonneville	Brougham	4.3	1980-1981		HB103x.590	D313		
Bonneville	Brougham	4.3	1986-1986		HB119x.594	D154		
Bonneville	Brougham	4.9	1977-1980		HB103x.590	D313		
Bonneville	Brougham	5.0	1981-1981		HB103x.590	D313		
Bonneville	Brougham	5.0	1983-1986		HB119x.594	D154		
Bonneville	Brougham	5.7	1977-1981		HB103x.590	D313		
Bonneville	Brougham	5.7	1982-1984		HB119x.594	D154		
Bonneville	Brougham	6.6	1976-1979		HB103x.590	D313		
Bonneville	Brougham	7.5	1976-1976		HB103x.590	D313		

CODE Breakdown

HB 245 x .631

Insert Compound Code

Make/Model	Submodel	Engine (Liter)	Years	Note	FRONT		REAR	
					Hawk #	FMSI	Hawk #	FMSI
PONTIAC CONT.								
Bonneville	GXP	4.6	2004-2005		HB467x.540	D1019	HB359x.543	D814
Bonneville	LE	3.8	1984-1986		HB119x.594	D154		
Bonneville	LE	3.8	1987-1991		HB396x.630	D215		
Bonneville	LE	4.3	1986-1986		HB119x.594	D154		
Bonneville	LE	5.0	1984-1986		HB119x.594	D154		
Bonneville	LE	5.7	1984-1984		HB119x.594	D154		
Bonneville	Safari	4.9	1979-1980		HB103x.590	D313		
Bonneville	Safari	5.0	1981-1981		HB103x.590	D313		
Bonneville	Safari	5.7	1979-1981		HB103x.590	D313		
Bonneville	Safari	6.6	1979-1979		HB103x.590	D313		
Bonneville	SE	3.8	1988-1991		HB396x.630	D215		
Bonneville	SE	3.8	1992-1993		HB129x.681	D505		
Bonneville	SE	3.8	1994-1998		HB217x.681	D623		
Bonneville	SE	3.8	2004-2005		HB360x.670	D699	HB359x.543	D814
Bonneville	SLE	3.8	2004-2005		HB360x.670	D699	HB359x.543	D814
Bonneville	SSE	3.8	1988-1991		HB396x.630	D215		
Bonneville	SSE	3.8	1992-1993		HB129x.681	D505		
Bonneville	SSE	3.8	1994-1998		HB217x.681	D623		
Bonneville	SSEi	3.8	1992-1993		HB129x.681	D505		
Bonneville		3.8	1980-1981		HB103x.590	D313		
Bonneville		3.8	1982-1986		HB119x.594	D154		
Bonneville		3.8	1987-1987		HB396x.630	D215		
Bonneville		3.8	1999-1999		HB217x.681	D623		
Bonneville		3.8	2000-2003		HB360x.670	D699	HB359x.543	D814
Bonneville		4.1	1982-1982		HB119x.594	D154		
Bonneville		4.3	1980-1981		HB103x.590	D313		
Bonneville		4.3	1986-1986		HB119x.594	D154		
Bonneville		4.9	1977-1980		HB103x.590	D313		
Bonneville		5.0	1981-1981		HB103x.590	D313		
Bonneville		5.0	1983-1986		HB119x.594	D154		
Bonneville		5.7	1977-1981		HB103x.590	D313		
Bonneville		5.7	1982-1984		HB119x.594	D154		
Bonneville		6.6	1973-1979		HB103x.590	D313		
Bonneville		7.5	1973-1976		HB103x.590	D313		
Catalina	Safari	4.9	1977-1980		HB103x.590	D313		
Catalina	Safari	5.0	1981-1981		HB103x.590	D313		
Catalina	Safari	5.7	1973-1973		HB103x.590	D313		
Catalina	Safari	5.7	1977-1981		HB103x.590	D313		
Catalina	Safari	6.6	1973-1979		HB103x.590	D313		
Catalina	Safari	7.5	1973-1976		HB103x.590	D313		
Catalina		3.8	1977-1981		HB103x.590	D313		
Catalina		4.3	1980-1981		HB103x.590	D313		
Catalina		4.9	1977-1980		HB103x.590	D313		
Catalina		5.0	1981-1981		HB103x.590	D313		
Catalina		5.7	1973-1973		HB103x.590	D313		
Catalina		5.7	1976-1981		HB103x.590	D313		
Catalina		6.6	1973-1978		HB103x.590	D313		
Catalina		7.5	1973-1976		HB103x.590	D313		
Firebird	Esprit	3.8	1977-1978		HB103x.590	D313		
Firebird	Esprit	3.8	1979-1981		HB103x.590	D313	HB119x.594	D154
Firebird	Esprit	4.1	1975-1976		HB103x.590	D313		
Firebird	Esprit	4.3	1981-1981		HB103x.590	D313	HB119x.594	D154

RACE COMPOUND CODES

DTC-70 - U | DTC-05 - H | MT-4 - L | DR-97 - J
 DTC-60 - G | HT-14 - V | Blue 9012 - E | HP Plus - N
 DTC-30 - W | HT-10 - S | Black - M

STREET COMPOUND CODES

HPS Performance Street - F | SuperDuty - P
 Performance Ceramic - Z
 LTS Light Truck & SUV - Y

Make/ Model	Submodel	Engine (Liter)	Years	Note	FRONT		REAR	
					Hawk #	FMSI	Hawk #	FMSI
PONTIAC CONT.								
Firebird	Esprit	4.9	1977-1977		HB103x.590	D313		
Firebird	Esprit	4.9	1979-1981		HB103x.590	D313	HB119x.594	D154
Firebird	Esprit	5.0	1977-1978		HB103x.590	D313		
Firebird	Esprit	5.0	1979-1980		HB103x.590	D313	HB119x.594	D154
Firebird	Esprit	5.7	1973-1978		HB103x.590	D313		
Firebird	Esprit	5.7	1979-1979		HB103x.590	D313	HB119x.594	D154
Firebird	Esprit	6.6	1973-1974		HB103x.590	D313		
Firebird	Esprit	6.6	1976-1976		HB103x.590	D313		
Firebird	Firehawk	5.7	1998-1998		HB249x.575	D749	HB250x.653	D750
Firebird	Formula	3.8	1981-1981		HB103x.590	D313	HB119x.594	D154
Firebird	Formula	4.3	1981-1981		HB103x.590	D313	HB119x.594	D154
Firebird	Formula	4.9	1977-1977		HB103x.590	D313		
Firebird	Formula	4.9	1979-1981		HB103x.590	D313	HB119x.594	D154
Firebird	Formula	5.0	1977-1978		HB103x.590	D313		
Firebird	Formula	5.0	1979-1981		HB103x.590	D313	HB119x.594	D154
Firebird	Formula	5.0	1989-1992	w/Performance Package	HB111x.610	D412	HB112x.540	D413
Firebird	Formula	5.0	1989-1992	w/o Performance Package	HB119x.594	D154	HB112x.540	D413
Firebird	Formula	5.7	1973-1978		HB103x.590	D313		
Firebird	Formula	5.7	1979-1979		HB103x.590	D313	HB119x.594	D154
Firebird	Formula	5.7	1989-1992	w/Performance Package	HB111x.610	D412	HB112x.540	D413
Firebird	Formula	5.7	1989-1992	w/o Performance Package	HB119x.594	D154	HB112x.540	D413
Firebird	Formula	5.7	1993-1993		HB129x.681	D505	HB112x.540	D413
Firebird	Formula	5.7	1994-1997		HB217x.681	D623	HB112x.540	D413
Firebird	Formula	5.7	1998-2002		HB249x.575	D749	HB250x.653	D750
Firebird	Formula	6.6	1973-1978		HB103x.590	D313		
Firebird	Formula	6.6	1979-1979		HB103x.590	D313	HB119x.594	D154
Firebird	Formula	7.5	1973-1974		HB103x.590	D313		
Firebird	Trans Am	3.8	1989-1989	w/Performance Package	HB111x.610	D412	HB112x.540	D413
Firebird	Trans Am	3.8	1989-1989	w/o Performance Package	HB119x.594	D154	HB112x.540	D413
Firebird	Trans Am	4.9	1979-1981		HB103x.590	D313	HB119x.594	D154
Firebird	Trans Am	5.0	1980-1981		HB103x.590	D313	HB119x.594	D154
Firebird	Trans Am	5.0	1988-1992	w/Performance Package	HB111x.610	D412	HB112x.540	D413
Firebird	Trans Am	5.0	1989-1992	w/o Performance Package	HB119x.594	D154		
Firebird	Trans Am	5.7	1973-1975		HB103x.590	D313		
Firebird	Trans Am	5.7	1988-1992	w/Performance Package	HB111x.610	D412	HB112x.540	D413
Firebird	Trans Am	5.7	1989-1992	w/o Performance Package	HB119x.594	D154		
Firebird	Trans Am	5.7	1993-1993		HB129x.681	D505	HB112x.540	D413
Firebird	Trans Am	5.7	1994-1997		HB217x.681	D623	HB112x.540	D413
Firebird	Trans Am	5.7	1998-2002		HB249x.575	D749	HB250x.653	D750
Firebird	Trans Am	6.6	1973-1978		HB103x.590	D313		
Firebird	Trans Am	6.6	1979-1979		HB103x.590	D313	HB119x.594	D154
Firebird	Trans Am	7.5	1973-1976		HB103x.590	D313		
Firebird	Trans Am GT	5.7	1994-1994		HB217x.681	D623	HB112x.540	D413
Firebird	Trans Am GTA	5.0	1989-1992	w/Performance Package	HB111x.610	D412	HB112x.540	D413
Firebird	Trans Am GTA	5.7	1989-1992	w/Performance Package	HB111x.610	D412	HB112x.540	D413
Firebird	Trans Am GTA SE	3.8	1989-1989	w/Performance Package	HB111x.610	D412	HB112x.540	D413
Firebird		2.8	1988-1989	w/Performance Package	HB111x.610	D412	HB112x.540	D413
Firebird		2.8	1989-1989	w/o Performance Package	HB119x.594	D154		
Firebird		3.1	1990-1992	w/Performance Package	HB111x.610	D412	HB112x.540	D413
Firebird		3.1	1990-1992	w/o Performance Package	HB119x.594	D154	HB112x.540	D413
Firebird		3.4	1993-1993		HB129x.681	D505	HB112x.540	D413
Firebird		3.4	1994-1995		HB217x.681	D623	HB112x.540	D413

CODE Breakdown

HB 245 x .631

Insert Compound Code

Make/Model	Submodel	Engine (Liter)	Years	Note	FRONT		REAR	
					Hawk #	FMSI	Hawk #	FMSI
PONTIAC CONT.								
Firebird		3.8	1977-1978		HB103x.590	D313		
Firebird		3.8	1979-1981		HB103x.590	D313	HB119x.594	D154
Firebird		3.8	1995-1997		HB217x.681	D623	HB112x.540	D413
Firebird		3.8	1998-2002		HB249x.575	D749	HB250x.653	D750
Firebird		4.1	1973-1976		HB103x.590	D313		
Firebird		4.3	1981-1981		HB103x.590	D313	HB119x.594	D154
Firebird		4.9	1977-1977		HB103x.590	D313		
Firebird		4.9	1979-1981		HB103x.590	D313	HB119x.594	D154
Firebird		5.0	1977-1978		HB103x.590	D313		
Firebird		5.0	1979-1980		HB103x.590	D313	HB119x.594	D154
Firebird		5.0	1988-1992	w/Performance Package	HB111x.610	D412	HB112x.540	D413
Firebird		5.0	1989-1992	w/o Performance Package	HB119x.594	D154		
Firebird		5.7	1973-1978		HB103x.590	D313		
Firebird		5.7	1979-1979		HB103x.590	D313	HB119x.594	D154
Firebird		5.7	1988-1988	w/Performance Package	HB111x.610	D412	HB112x.540	D413
Firebird		6.6	1974-1977		HB103x.590	D313		
G5	GT	2.4	2007-2007		HB524x.740	D1028	HB525x.540	D1033
G5		2.2	2007-2008		HB517x.690	D956		
G6	GT	3.5	2006-2007		HB524x.740	D1028	HB525x.540	D1033
G6	GT	3.9	2007-2007		HB524x.740	D1028	HB525x.540	D1033
G6	GTP	3.6	2007-2007		HB524x.740	D1028	HB525x.540	D1033
G6	GTP	3.9	2006-2006		HB524x.740	D1028	HB525x.540	D1033
G6		2.4	2006-2007		HB524x.740	D1028	HB525x.540	D1033
G6		3.5	2005-2005		HB554x.643	D1039		
G6		3.5	2005-2007		HB524x.740	D1028	HB525x.540	D1033
Grand Am	GT	2.3	1992-1995		HB390x.602	D506		
Grand Am	GT	2.4	1996-1997		HB390x.602	D506		
Grand Am	GT	3.1	1994-1997		HB390x.602	D506		
Grand Am	GT	3.3	1992-1993		HB390x.602	D506		
Grand Am	GT	3.4	2005-2005		HB425x.661	D727	HB359x.543	D814
Grand Am	GT1	3.4	2005-2005		HB425x.661	D727	HB359x.543	D814
Grand Am	LE	2.0	1987-1988		HB400x.630	D159		
Grand Am	LE	2.3	1988-1989		HB400x.630	D159		
Grand Am	LE	2.3	1990-1990	w/Performance Package	HB390x.602	D506		
Grand Am	LE	2.3	1990-1990	w/o Performance Package	HB400x.630	D159		
Grand Am	LE	2.3	1991-1991		HB390x.602	D506		
Grand Am	LE	2.5	1985-1989		HB400x.630	D159		
Grand Am	LE	2.5	1990-1990	w/Performance Package	HB390x.602	D506		
Grand Am	LE	2.5	1990-1990	w/o Performance Package	HB400x.630	D159		
Grand Am	LE	2.5	1991-1991		HB390x.602	D506		
Grand Am	LE	3.0	1985-1987		HB400x.630	D159		
Grand Am	SE	2.0	1987-1989		HB400x.630	D159		
Grand Am	SE	2.2	2005-2005		HB425x.661	D727	HB359x.543	D814
Grand Am	SE	2.3	1988-1989		HB400x.630	D159		
Grand Am	SE	2.3	1990-1990	w/Performance Package	HB390x.602	D506		
Grand Am	SE	2.3	1990-1990	w/o Performance Package	HB400x.630	D159		
Grand Am	SE	2.3	1991-1995		HB390x.602	D506		
Grand Am	SE	2.4	1996-1997		HB390x.602	D506		
Grand Am	SE	2.5	1987-1987		HB400x.630	D159		
Grand Am	SE	3.0	1986-1987		HB400x.630	D159		
Grand Am	SE	3.1	1994-1997		HB390x.602	D506		
Grand Am	SE	3.3	1992-1993		HB390x.602	D506		

RACE COMPOUND CODES

DTC-70 - U	DTC-05 - H	MT-4 - L	DR-97 - J
DTC-60 - G	HT-14 - V	Blue 9012 - E	HP Plus - N
DTC-30 - W	HT-10 - S	Black - M	

STREET COMPOUND CODES

HPS Performance Street - F	SuperDuty - P
Performance Ceramic - Z	
LTS Light Truck & SUV - Y	

Make/Model	Submodel	Engine		Note	FRONT		REAR	
		(Liter)	Years		Hawk #	FMSI	Hawk #	FMSI
PONTIAC CONT.								
Grand Am	SE	3.4	2005-2005		HB425x.661	D727	HB359x.543	D814
Grand Am		2.2	2002-2004		HB425x.661	D727	HB359x.543	D814
Grand Am		2.3	1988-1988		HB400x.630	D159		
Grand Am		2.4	1999-2001		HB425x.661	D727	HB359x.543	D814
Grand Am		2.5	1985-1988		HB400x.630	D159		
Grand Am		2.5	1991-1991		HB390x.602	D506		
Grand Am		3.0	1985-1987		HB400x.630	D159		
Grand Am		3.4	1999-2004		HB425x.661	D727	HB359x.543	D814
Grand Am		5.7	1973-1973		HB103x.590	D313		
Grand Am		5.7	1975-1975		HB103x.590	D313		
Grand Am		6.6	1973-1975		HB103x.590	D313		
Grand Am		7.5	1973-1975		HB103x.590	D313		
Grand LeMans	Safari	4.9	1977-1977		HB103x.590	D313		
Grand LeMans	Safari	5.7	1977-1977		HB103x.590	D313		
Grand LeMans	Safari	6.6	1975-1975		HB103x.590	D313		
Grand LeMans	Safari	6.6	1977-1977		HB103x.590	D313		
Grand LeMans		3.8	1977-1977		HB103x.590	D313		
Grand LeMans		4.1	1975-1976		HB103x.590	D313		
Grand LeMans		4.3	1976-1976		HB103x.590	D313		
Grand LeMans		4.9	1977-1977		HB103x.590	D313		
Grand LeMans		5.0	1977-1977		HB103x.590	D313		
Grand LeMans		5.7	1975-1977		HB103x.590	D313		
Grand LeMans		6.6	1975-1977		HB103x.590	D313		
Grand LeMans		7.5	1975-1976		HB103x.590	D313		
Grand Prix	Brougham	3.8	1981-1987		HB119x.594	D154		
Grand Prix	Brougham	4.1	1982-1982		HB119x.594	D154		
Grand Prix	Brougham	4.3	1981-1981		HB119x.594	D154		
Grand Prix	Brougham	4.3	1986-1987		HB119x.594	D154		
Grand Prix	Brougham	5.0	1983-1987		HB119x.594	D154		
Grand Prix	Brougham	5.7	1981-1984		HB119x.594	D154		
Grand Prix	GT	3.1	1991-1993		HB232x.681	D376	HB405x.543	D377
Grand Prix	GT	3.4	1991-1993		HB232x.681	D376	HB405x.543	D377
Grand Prix	GT	3.4	1995-1996		HB232x.681	D376	HB359x.543	D814
Grand Prix	GT	3.8	1997-1998		HB360x.670	D699	HB359x.543	D814
Grand Prix	GT	3.8	2006-2007		HB360x.670	D699	HB440x.606	D922
Grand Prix	GTP	3.4	1995-1996		HB232x.681	D376	HB359x.543	D814
Grand Prix	GTP	3.8	1997-1998		HB360x.670	D699	HB359x.543	D814
Grand Prix	GTP	3.8	2005-2005		HB360x.670	D699	HB440x.606	D922
Grand Prix	GTP	3.8	2005-2005		HB439x.555	D921	HB440x.606	D922
Grand Prix	GXP	5.3	2005-2008		HB439x.555	D921	HB440x.606	D922
Grand Prix	LE	2.3	1990-1991		HB232x.681	D376	HB405x.543	D377
Grand Prix	LE	2.8	1988-1989		HB232x.681	D376	HB405x.543	D377
Grand Prix	LE	3.1	1989-1993		HB232x.681	D376	HB405x.543	D377
Grand Prix	LE	3.4	1992-1993		HB232x.681	D376	HB405x.543	D377
Grand Prix	LE	3.8	1984-1987		HB119x.594	D154		
Grand Prix	LE	4.3	1986-1987		HB119x.594	D154		
Grand Prix	LE	5.0	1984-1987		HB119x.594	D154		
Grand Prix	LE	5.7	1984-1984		HB119x.594	D154		
Grand Prix	LJ	3.8	1979-1983		HB119x.594	D154		
Grand Prix	LJ	4.1	1982-1982		HB119x.594	D154		
Grand Prix	LJ	4.3	1980-1981		HB119x.594	D154		
Grand Prix	LJ	4.9	1977-1977		HB103x.590	D313		
Grand Prix	LJ	4.9	1978-1980		HB119x.594	D154		

CODE Breakdown

HB 245 x .631

Insert Compound Code

Make/Model	Submodel	Engine (Liter)	Years	Note	FRONT		REAR	
					Hawk #	FMSI	Hawk #	FMSI
PONTIAC CONT.								
Grand Prix	LJ	5.0	1978-1980		HB119x.594	D154		
Grand Prix	LJ	5.0	1983-1983		HB119x.594	D154		
Grand Prix	LJ	5.7	1977-1977		HB103x.590	D313		
Grand Prix	LJ	5.7	1981-1983		HB119x.594	D154		
Grand Prix	LJ	6.6	1977-1977		HB103x.590	D313		
Grand Prix	McLaren	3.1	1990-1990		HB232x.681	D376	HB405x.543	D377
Grand Prix	SE	2.3	1991-1991		HB232x.681	D376	HB405x.543	D377
Grand Prix	SE	2.8	1988-1989		HB232x.681	D376	HB405x.543	D377
Grand Prix	SE	3.1	1989-1993		HB232x.681	D376	HB405x.543	D377
Grand Prix	SE	3.1	1994-1994	Disc	HB232x.681	D376	HB359x.543	D814
Grand Prix	SE	3.1	1995-1996		HB232x.681	D376	HB359x.543	D814
Grand Prix	SE	3.1	1997-1998		HB360x.670	D699	HB359x.543	D814
Grand Prix	SE	3.4	1991-1993		HB232x.681	D376	HB405x.543	D377
Grand Prix	SE	3.4	1994-1994	Disc	HB232x.681	D376	HB359x.543	D814
Grand Prix	SE	3.8	1997-1997		HB360x.670	D699	HB359x.543	D814
Grand Prix	SJ	3.8	1979-1979		HB119x.594	D154		
Grand Prix	SJ	4.9	1978-1980		HB119x.594	D154		
Grand Prix	SJ	5.0	1978-1980		HB119x.594	D154		
Grand Prix	SJ	6.6	1977-1977		HB103x.590	D313		
Grand Prix	STE	3.1	1990-1993		HB232x.681	D376	HB405x.543	D377
Grand Prix	STE	3.4	1991-1993		HB232x.681	D376	HB405x.543	D377
Grand Prix		2.8	1988-1989		HB232x.681	D376	HB405x.543	D377
Grand Prix		3.1	1989-1989		HB232x.681	D376	HB405x.543	D377
Grand Prix		3.1	1996-1996		HB232x.681	D376	HB359x.543	D814
Grand Prix		3.1	1998-2003		HB360x.670	D699	HB359x.543	D814
Grand Prix		3.4	1992-1993		HB232x.681	D376	HB405x.543	D377
Grand Prix		3.8	1978-1987		HB119x.594	D154		
Grand Prix		3.8	1998-2003		HB360x.670	D699	HB359x.543	D814
Grand Prix		3.8	2004-2004		HB451x.668	D1000	HB450x.555	D999
Grand Prix		3.8	2005-2005		HB360x.670	D699	HB440x.606	D922
Grand Prix		3.8	2008-2008		HB360x.670	D699	HB450x.555	D999
Grand Prix		4.1	1982-1982		HB119x.594	D154		
Grand Prix		4.3	1980-1981		HB119x.594	D154		
Grand Prix		4.3	1986-1987		HB119x.594	D154		
Grand Prix		4.9	1977-1977		HB103x.590	D313		
Grand Prix		4.9	1978-1980		HB119x.594	D154		
Grand Prix		5.0	1978-1980		HB119x.594	D154		
Grand Prix		5.0	1983-1987		HB119x.594	D154		
Grand Prix		5.7	1976-1977		HB103x.590	D313		
Grand Prix		5.7	1981-1984		HB119x.594	D154		
Grand Prix		6.6	1973-1977		HB103x.590	D313		
Grand Prix		7.5	1973-1976		HB103x.590	D313		
Grand Safari		4.9	1977-1977		HB103x.590	D313		
Grand Safari		5.7	1977-1977		HB103x.590	D313		
Grand Safari		6.6	1973-1977		HB103x.590	D313		
Grand Safari		7.5	1973-1976		HB103x.590	D313		
Grandville	Brougham	6.6	1975-1975		HB103x.590	D313		
Grandville	Brougham	7.5	1975-1975		HB103x.590	D313		
Grandville		6.6	1973-1973		HB103x.590	D313		
Grandville		7.5	1973-1974		HB103x.590	D313		
GTO		5.7	2004-2004		HB460x.580	D1043	HB573x.615	D1048
GTO		6.0	2005-2006		HB247x.575	D731	HB573x.615	D1048

RACE COMPOUND CODES

DTC-70 - U | DTC-05 - H | MT-4 - L | DR-97 - J
 DTC-60 - G | HT-14 - V | Blue 9012 - E | HP Plus - N
 DTC-30 - W | HT-10 - S | Black - M

STREET COMPOUND CODES

HPS Performance Street - F | SuperDuty - P
 Performance Ceramic - Z
 LTS Light Truck & SUV - Y

Make/Model	Submodel	Engine (Liter)	Years	Note	FRONT		REAR	
					Hawk #	FMSI	Hawk #	FMSI
PONTIAC CONT.								
GTO		6.6	1973-1973		HB103x.590	D313		
GTO		7.5	1973-1973		HB103x.590	D313		
J2000	Sunbird	1.8	1984-1984		HB400x.630	D159		
J2000	Sunbird	2.0	1984-1984		HB400x.630	D159		
J2000	Sunbird LE	1.8	1984-1984		HB400x.630	D159		
J2000	Sunbird LE	2.0	1984-1984		HB400x.630	D159		
J2000	Sunbird SE	1.8	1984-1984		HB400x.630	D159		
J2000		1.8	1982-1983		HB400x.630	D159		
J2000		2.0	1983-1983		HB400x.630	D159		
LeMans	Safari	4.1	1973-1973		HB103x.590	D313		
LeMans	Safari	4.9	1977-1977		HB103x.590	D313		
LeMans	Safari	5.7	1973-1974		HB103x.590	D313		
LeMans	Safari	5.7	1976-1977		HB103x.590	D313		
LeMans	Safari	6.6	1973-1977		HB103x.590	D313		
LeMans	Safari	7.5	1973-1973		HB103x.590	D313		
LeMans	Safari	7.5	1976-1976		HB103x.590	D313		
LeMans	Sport	3.8	1977-1977		HB103x.590	D313		
LeMans	Sport	4.1	1973-1976		HB103x.590	D313		
LeMans	Sport	4.3	1976-1976		HB103x.590	D313		
LeMans	Sport	4.9	1977-1977		HB103x.590	D313		
LeMans	Sport	5.0	1977-1977		HB103x.590	D313		
LeMans	Sport	5.7	1973-1977		HB103x.590	D313		
LeMans	Sport	6.6	1973-1977		HB103x.590	D313		
LeMans	Sport	7.5	1973-1974		HB103x.590	D313		
LeMans	Sport	7.5	1976-1976		HB103x.590	D313		
LeMans		3.8	1977-1977		HB103x.590	D313		
LeMans		4.1	1973-1976		HB103x.590	D313		
LeMans		4.3	1976-1976		HB103x.590	D313		
LeMans		4.9	1977-1977		HB103x.590	D313		
LeMans		5.0	1977-1977		HB103x.590	D313		
LeMans		5.7	1973-1977		HB103x.590	D313		
LeMans		6.6	1973-1977		HB103x.590	D313		
LeMans		7.5	1973-1974		HB103x.590	D313		
LeMans		7.5	1976-1976		HB103x.590	D313		
Montana	SV6	3.5	2005-2005	FWD	HB360x.670	D699	HB359x.543	D814
Montana	SV6	3.5	2005-2005	AWD	HB373x.689	D844	HB359x.543	D814
Montana	SV6	3.5	2006-2006		HB360x.670	D699		
Montana	SV6	3.9	2006-2006		HB360x.670	D699		
Montana		3.4	1999-2001		HB360x.670	D699		
Montana		3.4	2002-2004	FWD	HB360x.670	D699	HB359x.543	D814
Montana		3.4	2002-2004	AWD	HB373x.689	D844	HB359x.543	D814
Montana		3.4	2005-2005		HB360x.670	D699		
Parisienne	Brougham	3.8	1983-1984		HB103x.590	D313		
Parisienne	Brougham	4.3	1985-1986		HB103x.590	D313		
Parisienne	Brougham	5.0	1983-1986		HB103x.590	D313		
Parisienne	Brougham	5.7	1983-1985		HB103x.590	D313		
Parisienne		3.8	1984-1984		HB103x.590	D313		
Parisienne		4.3	1985-1986		HB103x.590	D313		
Parisienne		5.0	1983-1986		HB103x.590	D313		
Parisienne		5.7	1983-1985		HB103x.590	D313		
Phoenix	LJ	2.5	1981-1983		HB400x.630	D159		
Phoenix	LJ	2.8	1981-1983		HB400x.630	D159		
Phoenix	SJ	2.8	1982-1983		HB400x.630	D159		

CODE Breakdown

HB 245 x .631

Insert Compound Code

Make/Model	Submodel	Engine (Liter)	Years	Note	FRONT		REAR	
					Hawk #	FMSI	Hawk #	FMSI
PONTIAC CONT.								
Phoenix		2.5	1981-1984		HB400x.630	D159		
Phoenix		2.8	1981-1984		HB400x.630	D159		
Safari		5.0	1987-1989		HB103x.590	D313		
Solstice	GXP	2.0	2007-2007		HB524x.740	D1028	HB478x.605	D1095
Solstice		2.4	2006-2008		HB524x.740	D1028	HB478x.605	D1095
Sunbird	GT	1.8	1986-1986		HB400x.630	D159		
Sunbird	GT	2.0	1987-1990		HB400x.630	D159		
Sunbird	GT	3.1	1991-1991		HB400x.630	D159		
Sunbird	GT	3.1	1992-1993		HB390x.602	D506		
Sunbird	LE	1.8	1985-1985		HB400x.630	D159		
Sunbird	LE	2.0	1985-1985		HB400x.630	D159		
Sunbird	LE	2.0	1989-1991		HB400x.630	D159		
Sunbird	LE	2.0	1992-1994		HB390x.602	D506		
Sunbird	LE	3.1	1991-1991		HB400x.630	D159		
Sunbird	LE	3.1	1993-1994		HB390x.602	D506		
Sunbird	SE	1.8	1985-1986		HB400x.630	D159		
Sunbird	SE	2.0	1986-1991		HB400x.630	D159		
Sunbird	SE	2.0	1992-1993		HB390x.602	D506		
Sunbird	SE	3.1	1991-1991		HB400x.630	D159		
Sunbird	SE	3.1	1992-1994		HB390x.602	D506		
Sunbird		1.8	1985-1986		HB400x.630	D159		
Sunbird		2.0	1985-1988		HB400x.630	D159		
Sunbird		2.0	1991-1991		HB400x.630	D159		
Sunfire	GT	2.4	1996-1997		HB393x.665	D914		
Sunfire	SE	2.2	1996-1997		HB393x.665	D914		
Sunfire	SE	2.4	1996-1997		HB393x.665	D914		
Sunfire		2.2	1998-2005		HB390x.602	D506		
Sunfire		2.4	1998-2002		HB390x.602	D506		
Torrent		3.4	2006-2006		HB472x.650	D833		
Trans Sport		3.1	1990-1991		HB396x.630	D215		
Trans Sport		3.1	1992-1993		HB129x.681	D505		
Trans Sport		3.1	1994-1995		HB217x.681	D623		
Trans Sport		3.4	1996-1996		HB217x.681	D623		
Trans Sport		3.4	1997-1998		HB360x.670	D699		
Trans Sport		3.8	1992-1993		HB129x.681	D505		
Trans Sport		3.8	1994-1995		HB217x.681	D623		
Ventura	Custom	4.1	1973-1975		HB103x.590	D313		
Ventura	Custom	4.3	1975-1975		HB103x.590	D313		
Ventura	Custom	5.7	1973-1975		HB103x.590	D313		
Ventura	S	4.1	1975-1975		HB103x.590	D313		
Ventura	S	4.3	1975-1975		HB103x.590	D313		
Ventura	S	5.7	1975-1975		HB103x.590	D313		
Ventura	SJ	3.8	1977-1977		HB103x.590	D313		
Ventura	SJ	4.1	1975-1976		HB103x.590	D313		
Ventura	SJ	4.3	1975-1976		HB103x.590	D313		
Ventura	SJ	4.9	1977-1977		HB103x.590	D313		
Ventura	SJ	5.0	1977-1977		HB103x.590	D313		
Ventura	SJ	5.7	1975-1977		HB103x.590	D313		
Ventura		2.5	1977-1977		HB103x.590	D313		
Ventura		3.8	1977-1977		HB103x.590	D313		
Ventura		4.1	1973-1976		HB103x.590	D313		
Ventura		4.3	1975-1976		HB103x.590	D313		
Ventura		4.9	1977-1977		HB103x.590	D313		

RACE COMPOUND CODES

DTC-70 - U	DTC-05 - H	MT-4 - L	DR-97 - J
DTC-60 - G	HT-14 - V	Blue 9012 - E	HP Plus - N
DTC-30 - W	HT-10 - S	Black - M	

STREET COMPOUND CODES

HPS Performance Street - F	SuperDuty - P
Performance Ceramic - Z	
LTS Light Truck & SUV - Y	

Make/Model	Submodel	Engine (Liter)	Years	Note	FRONT		REAR	
					Hawk #	FMSI	Hawk #	FMSI
PONTIAC CONT.								
Ventura		5.0	1977-1977		HB103x.590	D313		
Ventura		5.7	1973-1977		HB103x.590	D313		
Vibe	GT	1.8	2003-2005		HB441x.661	D923	HB329x.543	D823
Vibe	GT	1.8	2006-2006		HB441x.661	D923		
Vibe		1.8	2003-2008		HB441x.661	D923		
PORSCHE								
911	Carrera	2.7	1974-1974		HB171x.590	D45	HB172x.595	D31
911	Carrera	2.7	1975-1975		HB171x.590	D45		
911	Carrera	3.2	1984-1989		HB171x.590	D45		
911	Carrera	3.6	1991-1991		HB170x.650	D345		
911	Carrera	3.6	2008-2008		HB483x.635	D991		
911	Carrera 2	3.6	1993-1993		HB184x.650	D594		
911	Carrera 2	3.6	1994-1994		HB170x.650	D345	HB170x.650	D345
911	Carrera 2	3.6	1995-1996		HB170x.650	D345		
911	Carrera 2	3.6	1998-1998		HB170x.650	D345		
911	Carrera 2	3.6	2003-2003		HB550x.634	D917	HB290x.583	D738
911	Carrera 4	3.6	1989-1992		HB170x.650	D345		
911	Carrera 4	3.6	1993-1994		HB170x.650	D345	HB170x.650	D345
911	Carrera 4	3.6	1995-1995		HB550x.634	D917	HB170x.650	D345
911	Carrera 4	3.6	1996-1996		HB170x.650	D345	HB290x.606	D738
911	Carrera 4	3.6	1998-1998		HB170x.650	D345	HB290x.606	D738
911	Carrera 4	3.6	2002-2004		HB483x.635	D991		
911	Carrera 4	3.6	2006-2006		HB483x.635	D991	HB290x.583	D738
911	Carrera 4	3.6	2008-2008		HB483x.635	D991		
911	Carrera 4 Turbo Look	3.6	1993-1993		HB170x.650	D345		
911	Carrera 4S	3.6	1996-1998		HB141x.650	D372	HB290x.606	D738
911	Carrera 4S	3.6	2005-2005		HB483x.635	D991		
911	Carrera 4S	3.8	2008-2008		HB483x.635	D991		
911	Carrera S	3.8	2008-2008		HB483x.635	D991		
911	E	2.2	1970-1971		HB171x.590	D45	HB172x.595	D31
911	E	2.4	1972-1973		HB171x.590	D45	HB172x.595	D31
911	GT2	3.6	2002-2005		HB483x.635	D991		
911	GT2	3.6	2008-2008		HB483x.635	D991		
911	GT3	3.6	2004-2005		HB483x.635	D991		
911	GT3	3.6	2008-2008		HB483x.635	D991		
911	GT3 RS	3.6	2008-2008		HB483x.635	D991		
911	S	2.2	1970-1971		HB171x.590	D45	HB172x.595	D31
911	S	2.4	1972-1973		HB171x.590	D45	HB172x.595	D31
911	S	2.7	1974-1977		HB171x.590	D45		
911	SC	3.0	1978-1978		HB171x.590	D45	HB172x.595	D31
911	SC	3.0	1979-1983		HB170x.650	D345		
911	Targa	3.6	1998-1998		HB291x.642	D776	HB290x.606	D738
911	Targa 4	3.6	2008-2008		HB483x.635	D991		
911	Targa 4S	3.8	2008-2008		HB483x.635	D991		
911	Turbo	3.3	1991-1991		HB141x.650	D372	HB170x.650	D345
911	Turbo	3.6	1996-1997		HB184x.650	D594		
911	Turbo	3.6	2002-2005	w/Standard Brakes	HB483x.635	D991		
911	Turbo	3.6	2002-2005	w/Standard Brakes	HB550x.634	D917		
911	Turbo	3.6	2008-2008		HB483x.635	D991		
911	Turbo 3.6	3.6	1993-1994		HB184x.650	D594		
911	Turbo Look	3.6	1992-1994		HB170x.650	D345		
911	Turbo S	3.6	2005-2005		HB483x.635	D991		

CODE Breakdown

HB 245 x .631

Insert Compound Code

Make/Model	Submodel	Engine (Liter)	Years	Note	FRONT		REAR	
					Hawk #	FMSI	Hawk #	FMSI
PORSCHE CONT.								
911	Turbo S	3.6	2005-2005		HB550x.634	D917		
911		2.7	1974-1974		HB171x.590	D45	HB172x.595	D31
911		3.3	1987-1989		HB170x.650	D345		
911		3.4	1999-2001		HB550x.634	D917	HB290x.606	D738
911		3.6	2001-2001		HB483x.635	D991		
914	4	1.7	1970-1971		HB172x.595	D31		
914	6	2.0	1970-1971		HB172x.595	D31		
914		1.7	1972-1973		HB172x.595	D31		
914		1.8	1974-1975		HB172x.595	D31		
914		2.0	1972-1975		HB172x.595	D31		
924	S	2.5	1987-1987		HB199x.702	D443	HB198x.685	D445
924		2.0	1977-1978		HB198x.685	D445		
924		2.0	1979-1982		HB199x.702	D443	HB198x.685	D445
928	GT	5.0	1990-1991		HB141x.650	D372	HB170x.650	D345
928	GTS	5.4	1993-1994		HB184x.650	D594	HB170x.650	D345
928	GTS	5.4	1995-1995		HB184x.650	D594		
928	S	4.7	1983-1984		HB137x.690	D395	HB198x.685	D445
928	S	5.0	1985-1985		HB137x.690	D395	HB198x.685	D445
928	S	5.0	1986-1986		HB141x.650	D372	HB170x.650	D345
928	S4	5.0	1987-1991		HB141x.650	D372	HB170x.650	D345
928		4.5	1978-1980		HB199x.702	D443		
928		4.5	1981-1982		HB137x.690	D395	HB198x.685	D445
944	S2	3.0	1989-1989		HB170x.650	D345	HB198x.685	D445
944	S2	3.0	1990-1991		HB170x.650	D345	HB170x.650	D345
944		2.5	1985-1987		HB199x.702	D443	HB198x.685	D445
944		2.5	1985-1988		HB170x.650	D345		
944		2.7	1989-1989		HB170x.650	D345	HB198x.685	D445
944		2.7	1989-1989		HB199x.702	D443	HB198x.685	D445
968		3.0	1992-1992	w/o Sport Suspension	HB170x.650	D345		
968		3.0	1992-1995	w/Sport Suspension	HB141x.650	D372		
968		3.0	1993-1993	w/o Sport Suspension	HB170x.650	D345	HB170x.650	D345
968		3.0	1994-1994	w/o Sport Suspension	HB170x.650	D345		
968		3.0	1995-1995	w/o Sport Suspension	HB170x.650	D345	HB170x.650	D345
Boxster	Limited Edition	2.7	2008-2008		HB289x.610	D737	HB290x.583	D738
Boxster	RS 60 Spyder	3.4	2008-2008		HB289x.610	D737	HB290x.583	D738
Boxster	S	3.2	2001-2006		HB550x.634	D917	HB290x.606	D738
Boxster	S	3.4	2007-2007		HB550x.634	D917	HB290x.583	D738
Boxster	S	3.4	2008-2008		HB289x.610	D737		
Boxster	S Limited Edition	3.4	2008-2008		HB289x.610	D737		
Boxster		2.5	1997-1999		HB289x.610	D737	HB290x.606	D738
Boxster		2.7	2000-2004		HB289x.610	D737	HB290x.606	D738
Boxster		2.7	2005-2005		HB289x.610	D737		
Boxster		2.7	2008-2008		HB289x.610	D737		
Boxster		2.7	2008-2008		HB483x.635	D991		
Boxster		3.2	2000-2000		HB289x.610	D737	HB290x.606	D738
Cayenne	GTS	4.8	2008-2008		HB512x.605	D1007	HB502x.606	D978
Cayenne	S	4.5	2003-2006		HB501x.625	D1014	HB502x.606	D978
Cayenne	S	4.8	2008-2008		HB501x.625	D1014	HB502x.606	D978
Cayenne	Turbo	4.8	2008-2008		HB512x.605	D1007	HB502x.606	D978
Cayenne		3.2	2004-2006	18 in. Wheel	HB501x.625	D1014		
Cayenne		3.2	2005-2006	17 in. Wheel	HB512x.605	D1007		
Cayenne		3.6	2008-2008		HB512x.605	D1007	HB502x.606	D978
Cayman	S	3.4	2007-2007		HB550x.634	D917		

RACE COMPOUND CODES

DTC-70 - U	DTC-05 - H	MT-4 - L	DR-97 - J
DTC-60 - G	HT-14 - V	Blue 9012 - E	HP Plus - N
DTC-30 - W	HT-10 - S	Black - M	

STREET COMPOUND CODES

HPS Performance Street - F	SuperDuty - P
Performance Ceramic - Z	
LTS Light Truck & SUV - Y	

Make/Model	Submodel	Engine		Note	FRONT		REAR	
		(Liter)	Years		Hawk #	FMSI	Hawk #	FMSI
PORSCHE CONT.								
Cayman	S	3.4	2008-2008		HB289x.610	D737	HB290x.583	D738
Cayman		2.7	2007-2007		HB550x.634	D917	HB290x.583	D738
Cayman		2.7	2008-2008		HB289x.610	D737	HB290x.583	D738
ROLLS ROYCE								
Corniche		6.7	2000-2000		HB207x.580	D145		
Corniche		6.8	2001-2002		HB207x.580	D145		
SAAB								
99		1.7	1969-1971		HB172x.595	D31		
99		1.9	1971-1972		HB172x.595	D31		
99		2.0	1972-1974		HB172x.595	D31		
900	S	2.0	1988-1988		HB195x.640	D278		
900		2.0	1988-1988		HB195x.640	D278		
9000		2.0	1989-1989		HB195x.640	D278		
9-3	Aero	2.0	2004-2004		HB388x.756	D819	HB478x.605	D1095
9-3	Arc	2.0	2003-2004		HB388x.756	D819	HB478x.605	D1095
9-3	SE	2.0	1999-1999		HB388x.756	D819	HB389x.583	D709
9-3	SE	2.0	2001-2002		HB388x.756	D819	HB389x.583	D709
9-3	SE	2.0	2003-2003		HB388x.756	D819	HB478x.605	D1095
9-3	Viggen	2.3	1999-2002		HB388x.756	D819	HB389x.583	D709
9-3		2.0	1999-2001		HB388x.756	D819	HB389x.583	D709
9-5	2.3T	2.3	2008-2008		HB354x.756	D840	HB227x.630	D692
9-5	2.3T	2.3	2008-2008	w/Wear Sensor	HB354x.756A	D840	HB227x.630	D692
9-5	Aero	2.3	2000-2005		HB388x.756	D819	HB227x.630	D692
9-5	Aero	2.3	2008-2008		HB354x.756	D840	HB227x.630	D692
9-5	Aero	2.3	2008-2008	w/Wear Sensor	HB354x.756A	D840	HB227x.630	D692
9-5	Arc	2.3	2004-2005		HB388x.756	D819	HB227x.630	D692
9-5	Arc	3.0	2002-2003		HB388x.756	D819	HB227x.630	D692
9-5	Linear	2.3	2002-2005		HB388x.756	D819	HB227x.630	D692
9-5		2.3	1999-1999	From Serial Number X3025752	HB388x.756	D819	HB227x.630	D692
9-5		2.3	1999-1999	To Serial Number X3025751	HB388x.756	D819	HB389x.583	D709
9-5		2.3	2000-2000		HB388x.756	D819	HB389x.583	D709
9-5		2.3	2000-2001		HB388x.756	D819	HB227x.630	D692
9-5		3.0	1999-1999	From Serial Number X3025752	HB388x.756	D819	HB227x.630	D692
9-5		3.0	1999-1999	To Serial Number X3025751	HB388x.756	D819	HB389x.583	D709
9-5		3.0	2000-2001		HB388x.756	D819	HB227x.630	D692
9-2X	2.5i	2.5	2006-2006		HB432x.661	D929	HB452x.545	D1004
9-2X	Aero	2.0	2005-2005		HB432x.661	D929	HB452x.545	D1004
9-2X	Aero	2.5	2006-2006		HB432x.661	D929	HB452x.545	D1004
9-2X	Linear	2.5	2005-2005		HB432x.661	D929	HB452x.545	D1004
9-7X	Arc	5.3	2005-2005		HB382x.657	D882	HB383x.685	D883
9-7X	Linear	4.2	2005-2005		HB382x.657	D882	HB383x.685	D883
SATURN								
Ion	Red Line	2.0	2004-2007		HB524x.740	D1028	HB525x.540	D1033
Ion		2.2	2003-2004		HB517x.690	D956		
Ion-1		2.2	2005-2005		HB517x.690	D956		
Ion-2		2.2	2005-2007		HB517x.690	D956		
Ion-3		2.2	2005-2007		HB517x.690	D956		
Ion-3		2.4	2006-2007		HB517x.690	D956		
L Series		2.2	2002-2004		HB388x.756	D819	HB389x.583	D709
L Series		3.0	2002-2004		HB388x.756	D819	HB389x.583	D709
L300		3.0	2005-2005		HB388x.756	D819	HB389x.583	D709
LS1		2.2	2001-2001		HB388x.756	D819	HB389x.583	D709

CODE Breakdown

HB 245 x .631

Insert Compound Code

Make/Model	Submodel	Engine		Note	FRONT		REAR	
		(Liter)	Years		Hawk #	FMSI	Hawk #	FMSI
SATURN CONT.								
LS2		3.0	2001-2001		HB388x.756	D819	HB389x.583	D709
LW Series		2.2	2001-2003		HB388x.756	D819	HB389x.583	D709
LW Series		3.0	2001-2003		HB388x.756	D819	HB389x.583	D709
Relay-1		3.9	2007-2007		HB360x.670	D699		
Relay-2		3.5	2005-2006		HB360x.670	D699		
Relay-2		3.9	2007-2007		HB360x.670	D699		
Relay-3		3.5	2005-2006		HB360x.670	D699		
Relay-3		3.9	2006-2007		HB360x.670	D699		
SC2		1.9	1991-1992		HB409x.661	D507	HB359x.543	D814
Sky	Red Line	2.0	2007-2008		HB524x.740	D1028	HB478x.605	D1095
Sky		2.4	2007-2008		HB524x.740	D1028	HB478x.605	D1095
SL1		1.9	1991-1998		HB409x.661	D507	HB359x.543	D814
SL1		1.9	1999-2002		HB409x.661	D507		
SL2		1.9	1991-1998		HB409x.661	D507	HB359x.543	D814
SL2		1.9	1999-2002		HB409x.661	D507		
SW1		1.9	1993-1998		HB409x.661	D507	HB359x.543	D814
SW1		1.9	1999-1999		HB409x.661	D507		
SW2		1.9	1993-1998		HB409x.661	D507	HB359x.543	D814
SW2		1.9	1999-2001		HB409x.661	D507		
Vue	Green Line	2.4	2007-2007		HB472x.650	D833		
Vue	Red Line	3.5	2004-2004		HB472x.650	D833		
Vue	Red Line	3.5	2006-2006		HB472x.650	D833		
Vue		2.2	2002-2007		HB472x.650	D833		
Vue		3.0	2002-2003		HB472x.650	D833		
Vue		3.5	2004-2007		HB472x.650	D833		
SCION								
tC	Spec	2.4	2007-2008		HB328x.685	D817		
tC		2.4	2005-2009		HB328x.685	D817		
xA		1.5	2004-2004		HB493x.650	D990		
xB		1.5	2004-2004		HB493x.650	D990		
SUBARU								
B9 Tribeca	Limited	3.0	2006-2007		HB533x.668	D1078		
B9 Tribeca		3.0	2006-2007		HB533x.668	D1078		
Baja	Sport	2.5	2005-2006		HB432x.661	D929	HB434x.543	D770
Baja	Turbo	2.5	2005-2006		HB432x.661	D929	HB434x.543	D770
Baja		2.5	2003-2004		HB432x.661	D929	HB434x.543	D770
Brat	DL	1.8	1982-1982		HB202x.580	D282		
DL		1.6	1981-1983		HB202x.580	D282		
DL		1.8	1981-1983		HB202x.580	D282		
Forester	L	2.5	1998-1998		HB352x.665	D721	HB434x.543	D770
Forester	S	2.5	1998-1998		HB352x.665	D721	HB434x.543	D770
Forester	Sports 2.5 X	2.5	2008-2008		HB432x.661	D929		
Forester	Sports 2.5 XT	2.5	2008-2008		HB432x.661	D929	HB452x.545	D1004
Forester	X	2.5	2003-2005		HB432x.661	D929		
Forester	X	2.5	2006-2008		HB432x.661	D929	HB452x.545	D1004
Forester	X L.L. Bean	2.5	2006-2008		HB432x.661	D929	HB452x.545	D1004
Forester	XS	2.5	2003-2003		HB432x.661	D929	HB434x.543	D770
Forester	XS	2.5	2004-2005		HB432x.661	D929	HB452x.545	D1004
Forester	XT	2.5	2004-2005		HB432x.661	D929	HB452x.545	D1004
Forester	XT Limited	2.5	2006-2008		HB432x.661	D929	HB452x.545	D1004
Forester		2.5	1998-1998		HB352x.665	D721		
Forester		2.5	1999-2002		HB352x.665	D721	HB434x.543	D770

RACE COMPOUND CODES

DTC-70 - U	DTC-05 - H	MT-4 - L	DR-97 - J
DTC-60 - G	HT-14 - V	Blue 9012 - E	HP Plus - N
DTC-30 - W	HT-10 - S	Black - M	

STREET COMPOUND CODES

HPS Performance Street - F	SuperDuty - P
Performance Ceramic - Z	
LTS Light Truck & SUV - Y	

Make/ Model	Submodel	Engine		Note	FRONT		REAR	
		(Liter)	Years		Hawk #	FMSI	Hawk #	FMSI
SUBARU CONT.								
GL		1.8	1981-1983		HB202x.580	D282		
Impreza	2.5i	2.5	2006-2007		HB432x.661	D929	HB452x.545	D1004
Impreza	2.5i	2.5	2008-2008		HB432x.661	D929	HB557x.545	D1114
Impreza	Brighton	1.8	1997-1997		HB424x.665	D722		
Impreza	Brighton	2.2	1997-1997		HB424x.665	D722		
Impreza	L	1.8	1993-1996		HB408x.665	D470		
Impreza	L	1.8	1995-1994		HB408x.665	D470	HB367x.585	D383
Impreza	L	2.2	1995-1996		HB408x.665	D470	HB367x.585	D383
Impreza	L	2.2	1997-1997		HB424x.665	D722		
Impreza	LS	1.8	1993-1994		HB408x.665	D470	HB367x.585	D383
Impreza	LX	2.2	1995-1996		HB408x.665	D470	HB367x.585	D383
Impreza	Outback	1.8	1995-1995		HB408x.665	D470	HB367x.585	D383
Impreza	Outback	2.2	1996-1996		HB408x.665	D470	HB367x.585	D383
Impreza	Outback	2.2	1997-1999		HB424x.665	D722		
Impreza	Outback	2.2	2000-2001		HB424x.665	D722	HB434x.543	D770
Impreza	Outback	2.5	2002-2002	Drum	HB352x.665	D721		
Impreza	Outback	2.5	2002-2002	Disc	HB432x.661	D929		
Impreza	Outback	2.5	2003-2003		HB432x.661	D929	HB434x.543	D770
Impreza	Outback	2.5	2004-2004		HB432x.661	D929	HB452x.545	D1004
Impreza	Outback Sport	2.5	2005-2007		HB432x.661	D929	HB452x.545	D1004
Impreza	Outback Sport	2.5	2008-2008		HB432x.661	D929	HB557x.545	D1114
Impreza	RS	2.5	1998-1999		HB424x.665	D722	HB367x.585	D383
Impreza	RS	2.5	2000-2001		HB424x.665	D722	HB434x.543	D770
Impreza	RS	2.5	2002-2003		HB432x.661	D929	HB434x.543	D770
Impreza	RS	2.5	2004-2005		HB432x.661	D929	HB452x.545	D1004
Impreza	TS	2.5	2002-2003		HB432x.661	D929	HB434x.543	D770
Impreza	TS	2.5	2004-2004		HB432x.661	D929	HB452x.545	D1004
Impreza	WRX	2.0	2002-2002		HB352x.665	D721	HB434x.543	D770
Impreza	WRX	2.5	2006-2007		HB178x.564	D460	HB179x.630	D461
Impreza	WRX STi	2.5	2004-2009		HB453x.585	D1001	HB180x.560	D961
Impreza	WRX STi Limited	2.5	2007-2007		HB453x.585	D1001	HB180x.560	D961
Impreza		1.8	1993-1995		HB408x.665	D470		
Impreza		2.2	1998-2001	15 in. Wheel	HB352x.665	D721		
Impreza		2.2	1998-2001	16 in. Wheel	HB424x.665	D722		
Legacy	2.5i	2.5	2006-2006		HB432x.661	D929	HB557x.545	D1114
Legacy	2.5i	2.5	2008-2008		HB432x.661	D929	HB557x.545	D1114
Legacy	2.5i Limited	2.5	2007-2008		HB432x.661	D929	HB557x.545	D1114
Legacy	2.5i Special Edition	2.5	2008-2008		HB432x.661	D929		
Legacy	3.0 R Limited	3.0	2008-2008		HB533x.668	D1078	HB434x.543	D770
Legacy	Brighton	2.2	1995-1998		HB408x.665	D470		
Legacy	GT	2.2	1994-1994		HB408x.665	D470	HB367x.585	D383
Legacy	GT	2.5	1996-1996		HB408x.665	D470	HB367x.585	D383
Legacy	GT	2.5	1997-1998		HB352x.665	D721	HB367x.585	D383
Legacy	GT	2.5	2006-2006		HB533x.668	D1078	HB434x.543	D770
Legacy	GT Limited	2.5	2007-2008		HB533x.668	D1078	HB434x.543	D770
Legacy	GT Spec.B	2.5	2006-2008		HB533x.668	D1078	HB434x.543	D770
Legacy	L	2.2	1990-1996		HB408x.665	D470	HB367x.585	D383
Legacy	L	2.2	1997-1998	15 or 16 in. Wheels	HB352x.665	D721	HB367x.585	D383
Legacy	L	2.2	1997-1998	14 in. Wheel	HB424x.665	D722	HB367x.585	D383
Legacy	L Alpine	2.2	1994-1994		HB408x.665	D470	HB367x.585	D383
Legacy	L OutDoor	2.2	1994-1994		HB408x.665	D470	HB367x.585	D383
Legacy	L SunSport	2.2	1994-1994		HB408x.665	D470	HB367x.585	D383
Legacy	Limited	2.5	1997-1998		HB352x.665	D721	HB367x.585	D383

CODE Breakdown

HB 245 x .631

Insert Compound Code

Make/Model	Submodel	Engine (Liter)	Years	Note	FRONT		REAR	
					Hawk #	FMSI	Hawk #	FMSI
SUBARU CONT.								
Legacy	LS	2.2	1990-1990		HB408x.665	D470	HB367x.585	D383
Legacy	LS	2.2	1994-1996		HB408x.665	D470	HB367x.585	D383
Legacy	LS SP	2.2	1991-1993		HB408x.665	D470	HB367x.585	D383
Legacy	LSi	2.2	1991-1995		HB408x.665	D470	HB367x.585	D383
Legacy	LSi	2.5	1996-1996		HB408x.665	D470	HB367x.585	D383
Legacy	LSi	2.5	1997-1997	15 or 16 in. Wheels	HB352x.665	D721	HB367x.585	D383
Legacy	LSi	2.5	1997-1997	14 in. Wheel	HB424x.665	D722	HB367x.585	D383
Legacy	Outback	2.2	1995-1996		HB408x.665	D470	HB367x.585	D383
Legacy	Outback	2.5	1996-1996		HB408x.665	D470	HB367x.585	D383
Legacy	Outback	2.5	1997-1998	15 or 16 in. Wheels	HB352x.665	D721	HB367x.585	D383
Legacy	Outback	2.5	1997-1998	14 in. Wheel	HB424x.665	D722	HB367x.585	D383
Legacy	Outback	2.5	1999-1999		HB352x.665	D721	HB367x.585	D383
Legacy	Postal	2.2	1995-1996		HB408x.665	D470		
Legacy	Postal	2.2	1997-1998	15 or 16 in. Wheels	HB352x.665	D721		
Legacy	Postal	2.2	1997-1998	14 in. Wheel	HB424x.665	D722		
Legacy	Sport	2.2	1991-1994		HB408x.665	D470	HB367x.585	D383
Legacy		2.2	1990-1990		HB408x.665	D470	HB367x.585	D383
Legacy		2.2	1994-1994		HB408x.665	D470	HB367x.585	D383
Legacy		2.2	1995-1995		HB408x.665	D470		
Legacy		2.2	1999-1999		HB424x.665	D722	HB367x.585	D383
Legacy		2.5	1999-1999		HB424x.665	D722	HB367x.585	D383
Legacy		2.5	2000-2001	Disc	HB352x.665	D721	HB434x.543	D770
Legacy		2.5	2000-2001	Drum	HB424x.665	D722		
Legacy		2.5	2002-2002		HB352x.665	D721	HB434x.543	D770
Legacy		2.5	2002-2005				HB434x.543	D770
Legacy		2.5	2003-2005		HB432x.661	D929	HB434x.543	D770
Outback	2.5i	2.5	2006-2008		HB432x.661	D929	HB557x.545	D1114
Outback	2.5i Basic	2.5	2007-2007		HB432x.661	D929	HB557x.545	D1114
Outback	2.5i L.L. Bean	2.5	2008-2008		HB432x.661	D929	HB557x.545	D1114
Outback	2.5i Limited	2.5	2007-2007		HB432x.661	D929	HB557x.545	D1114
Outback	R	3.0	2006-2006		HB432x.661	D929	HB557x.545	D1114
Outback	R L.L. Bean	3.0	2006-2008		HB432x.661	D929	HB557x.545	D1114
Outback	R VDC Limited	3.0	2006-2006		HB432x.661	D929	HB557x.545	D1114
Outback	XT	2.5	2006-2006		HB432x.661	D929	HB557x.545	D1114
Outback	XT Limited	2.5	2007-2008		HB432x.661	D929	HB557x.545	D1114
Outback		2.5	2001-2001		HB424x.665	D722	HB434x.543	D770
Outback		2.5	2002-2004		HB432x.661	D929	HB434x.543	D770
Outback		2.5	2005-2005		HB432x.661	D929	HB557x.545	D1114
Outback		2.5	2008-2008		HB432x.661	D929	HB557x.545	D1114
Outback		3.0	2001-2001		HB424x.665	D722		
Outback		3.0	2002-2004		HB432x.661	D929	HB434x.543	D770
Outback		3.0	2005-2005		HB432x.661	D929	HB557x.545	D1114
Tribeca	Limited	3.6	2008-2008		HB533x.668	D1078		
Tribeca	Sport	3.6	2008-2008		HB533x.668	D1078		
Tribeca		3.6	2008-2008		HB533x.668	D1078		
SUZUKI								
Sidekick	JLX	1.6	1992-1995		HB384x.587	D556		
Sidekick	JS	1.6	1992-1998		HB384x.587	D556		
Sidekick	JX	1.6	1992-1998		HB384x.587	D556		
Sidekick	Sport	1.8	1996-1998		HB384x.587	D556		
Vitara		1.6	2000-2001		HB384x.587	D556		
Vitara		2.0	2000-2003		HB384x.587	D556		
Vitara		2.5	2004-2004		HB384x.587	D556		

RACE COMPOUND CODES

DTC-70 - U | DTC-05 - H | MT-4 - L | DR-97 - J
 DTC-60 - G | HT-14 - V | Blue 9012 - E | HP Plus - N
 DTC-30 - W | HT-10 - S | Black - M

STREET COMPOUND CODES

HPS Performance Street - F | SuperDuty - P
 Performance Ceramic - Z
 LTS Light Truck & SUV - Y

Make/ Model	Submodel	Engine		Note	FRONT		REAR	
		(Liter)	Years		Hawk #	FMSI	Hawk #	FMSI
TOYOTA								
4Runner	DLX	2.4	1989-1989		HB317x.591	D410		
4Runner	DLX	3.0	1989-1989		HB317x.591	D410		
4Runner	Limited	3.4	1996-1997		HB311x.591	D611		
4Runner	Limited	4.0	2005-2008		HB490x.665	D976	HB477x.610	D606
4Runner	Limited	4.7	2005-2008		HB490x.665	D976	HB477x.610	D606
4Runner	Sport	4.0	2005-2008		HB490x.665	D976	HB477x.610	D606
4Runner	Sport	4.7	2005-2008		HB490x.665	D976	HB477x.610	D606
4Runner	SR5	2.4	1989-1989		HB317x.591	D410		
4Runner	SR5	2.4	1990-1991		HB315x.669	D436		
4Runner	SR5	2.4	1992-1995		HB311x.591	D611		
4Runner	SR5	3.0	1989-1989		HB317x.591	D410		
4Runner	SR5	3.0	1990-1991		HB315x.669	D436		
4Runner	SR5	3.0	1992-1995		HB311x.591	D611		
4Runner	SR5	3.4	1996-1997		HB311x.591	D611		
4Runner	SR5	4.0	2005-2006		HB490x.665	D976	HB477x.610	D606
4Runner	SR5	4.0	2008-2008		HB490x.665	D976	HB477x.610	D606
4Runner	SR5	4.7	2005-2006		HB490x.665	D976	HB477x.610	D606
4Runner	SR5	4.7	2008-2008		HB490x.665	D976	HB477x.610	D606
4Runner		2.7	1996-2000		HB311x.591	D611		
4Runner		3.4	1998-2001		HB311x.591	D611		
4Runner		4.0	2003-2004		HB490x.665	D976	HB477x.610	D606
4Runner		4.7	2003-2004		HB490x.665	D976	HB477x.610	D606
Avalon	XL	3.0	1995-1997		HB318x.669	D697		
Avalon	XL	3.0	2002-2003		HB320x.669	D707		
Avalon	XLS	3.0	1995-1995		HB318x.669	D697		
Avalon	XLS	3.0	1997-1997		HB318x.669	D697		
Avalon	XLS	3.0	2002-2003		HB320x.669	D707		
Avalon		3.0	1998-2001		HB320x.669	D707		
Camry	DLX	1.8	1984-1986		HB191x.590	D242		
Camry	DLX	2.0	1984-1988		HB191x.590	D242		
Camry	DLX	2.0	1989-1991		HB191x.590	D242	HB401x.587	D325
Camry	DLX	2.5	1988-1988		HB191x.590	D242		
Camry	DLX	2.5	1989-1991		HB191x.590	D242	HB401x.587	D325
Camry	DLX All Trac	2.0	1988-1988		HB191x.590	D242		
Camry	DLX All Trac	2.0	1989-1991		HB191x.590	D242	HB401x.587	D325
Camry	LE	2.0	1984-1988		HB191x.590	D242		
Camry	LE	2.0	1989-1991		HB191x.590	D242	HB401x.587	D325
Camry	LE	2.5	1988-1988		HB191x.590	D242		
Camry	LE	2.5	1989-1991		HB191x.590	D242	HB401x.587	D325
Camry	LE	3.0	2006-2006		HB474x.681	D908		
Camry	LE All Trac	2.0	1988-1988		HB191x.590	D242		
Camry	LE All Trac	2.0	1989-1991		HB191x.590	D242	HB401x.587	D325
Camry	SE	3.3	2006-2006		HB474x.681	D908		
Camry	XLE	3.0	2006-2006		HB474x.681	D908		
Camry		2.0	1988-1991		HB191x.590	D242		
Camry		2.2	1998-1999		HB310x.689	D562		
Camry		2.2	2000-2000	14 in. Wheel	HB310x.689	D562		
Camry		2.2	2000-2000	15 in. Wheel	HB318x.669	D697		
Camry		2.2	2001-2001		HB318x.669	D697		
Camry		2.4	2002-2006		HB474x.681	D908		
Camry		3.0	2000-2001		HB320x.669	D707		
Camry		3.0	2002-2005		HB474x.681	D908		
Camry		3.3	2004-2005		HB474x.681	D908		

CODE Breakdown

HB 245 x .631

Insert Compound Code

Make/Model	Submodel	Engine (Liter)	Years	Note	FRONT		REAR	
					Hawk #	FMSI	Hawk #	FMSI
TOYOTA CONT.								
Celica	GT	1.8	2002-2005		HB328x.685	D817	HB329x.543	D823
Celica	GT	2.0	1986-1989		HB191x.590	D242		
Celica	GT	2.2	1990-1993		HB191x.590	D242		
Celica	GT	2.2	1994-1998		HB318x.669	D697	HB401x.587	D325
Celica	GTS	1.8	2001-2005		HB328x.685	D817	HB329x.543	D823
Celica	GTS Sport	2.0	1986-1989		HB191x.590	D242		
Celica	GTS Sport	2.2	1990-1993		HB191x.590	D242		
Celica	ST	1.6	1990-1993		HB191x.590	D242		
Celica	ST	1.8	1994-1997		HB310x.689	D562		
Celica	ST	2.0	1987-1989		HB191x.590	D242		
Celica	ST Sport	2.0	1986-1986		HB191x.590	D242		
Celica		1.8	2000-2000		HB493x.650	D990		
Corolla	CE	1.8	2006-2008		HB441x.661	D923		
Corolla	DLX	1.6	1984-1992		HB191x.590	D242		
Corolla	DLX	1.8	1984-1985		HB191x.590	D242		
Corolla	DLX All Trac	1.6	1988-1992		HB191x.590	D242		
Corolla	DX	1.6	1993-1997		HB310x.689	D562		
Corolla	DX	1.8	1993-1997		HB310x.689	D562		
Corolla	FX	1.6	1987-1988		HB191x.590	D242		
Corolla	FX16	1.6	1987-1987		HB191x.590	D242	HB203x.550	D305
Corolla	FX16 GTS	1.6	1988-1988		HB191x.590	D242	HB401x.587	D325
Corolla	GTS	1.6	1988-1991		HB191x.590	D242	HB401x.587	D325
Corolla	LE	1.6	1984-1984		HB191x.590	D242		
Corolla	LE	1.8	1993-1995		HB310x.689	D562		
Corolla	LE	1.8	2006-2008		HB441x.661	D923		
Corolla	LE LTD	1.6	1985-1986		HB191x.590	D242		
Corolla	S	1.8	2006-2008		HB441x.661	D923		
Corolla	Sport	1.8	2008-2008		HB441x.661	D923		
Corolla	Sport DLX	1.6	1984-1984		HB191x.590	D242		
Corolla	SR5	1.6	1988-1991		HB191x.590	D242		
Corolla	SR5 All Trac	1.6	1988-1990		HB191x.590	D242		
Corolla	XRS	1.8	2005-2006		HB441x.661	D923	HB329x.543	D823
Corolla		1.6	1990-1992		HB191x.590	D242		
Corolla		1.6	1993-1997		HB310x.689	D562		
Corolla		1.8	1997-1998		HB310x.689	D562		
Corolla		1.8	1998-2002		HB321x.650	D741		
Corolla		1.8	2003-2004		HB441x.661	D923		
Corona	Custom	2.2	1977-1978		HB169x.560	D57		
Corona	DLX	2.2	1975-1978		HB169x.560	D57		
Corona	SR5	2.2	1975-1976		HB169x.560	D57		
Corona		2.0	1973-1974		HB169x.560	D57		
Corona		2.2	1979-1980		HB169x.560	D57		
Cressida	Luxury	3.0	1989-1992		HB407x.602	D389		
Cressida		2.6	1978-1980		HB169x.560	D57		
Crown		2.3	1968-1970		HB169x.560	D57		
Echo		1.5	2001-2005		HB493x.650	D990		
FJ Cruiser	Trail Teams	4.0	2008-2008		HB490x.665	D976	HB477x.610	D606
FJ Cruiser	TRD Special	4.0	2007-2007		HB312x.591	D502	HB477x.610	D606
FJ Cruiser		4.0	2007-2007		HB312x.591	D502	HB477x.610	D606
FJ Cruiser		4.0	2008-2008		HB490x.665	D976	HB477x.610	D606
Land Cruiser		4.0	1991-1992		HB312x.591	D502		
Land Cruiser		4.5	1993-1994		HB312x.591	D502		
Land Cruiser		4.5	1995-1997		HB312x.591	D502	HB477x.610	D606

RACE COMPOUND CODES

DTC-70 - U	DTC-05 - H	MT-4 - L	DR-97 - J
DTC-60 - G	HT-14 - V	Blue 9012 - E	HP Plus - N
DTC-30 - W	HT-10 - S	Black - M	

STREET COMPOUND CODES

HPS Performance Street - F	SuperDuty - P
Performance Ceramic - Z	
LTS Light Truck & SUV - Y	

Make/Model	Submodel	Engine (Liter)	Years	Note	FRONT		REAR	
					Hawk #	FMSI	Hawk #	FMSI
TOYOTA CONT.								
Land Cruiser		4.7	1998-2007		HB313x.685	D772	HB427x.685	D773
Land Cruiser		5.7	2008-2008		HB589x.704	D1303	HB590x.692	D1304
Matrix	XR	1.8	2003-2005		HB441x.661	D923	HB329x.543	D823
Matrix	XR	1.8	2006-2008		HB441x.661	D923		
Matrix	XRS	1.8	2003-2006		HB441x.661	D923	HB329x.543	D823
Matrix		1.8	2003-2005		HB441x.661	D923	HB329x.543	D823
Matrix		1.8	2006-2008		HB441x.661	D923		
MR2		1.6	1985-1989		HB191x.590	D242		
MR2		2.0	1991-1995		HB191x.590	D242		
MR2		2.2	1991-1995		HB191x.590	D242		
MR2 Spyder		1.8	2000-2005		HB493x.650	D990		
Paseo	Convertible	1.5	1997-1997		HB191x.590	D242		
Paseo		1.5	1992-1998		HB191x.590	D242		
Pickup	DLX	2.4	1989-1992	4WD	HB315x.669	D436		
Pickup	DLX	2.4	1993-1995		HB315x.669	D436		
Pickup	DLX	3.0	1988-1988		HB317x.591	D410		
Pickup	DLX	3.0	1989-1992	4WD	HB315x.669	D436		
Pickup	DLX	3.0	1989-1992	2WD	HB407x.602	D389		
Pickup	DLX	3.0	1993-1995		HB315x.669	D436		
Pickup	SHT BD DLX EXC	3.0	1991-1992	4WD	HB315x.669	D436		
Pickup	SHT BD DLX EXC	3.0	1991-1992	2WD	HB407x.602	D389		
Pickup	SR5	2.4	1989-1990	4WD	HB315x.669	D436		
Pickup	SR5	3.0	1988-1988		HB317x.591	D410		
Pickup	SR5	3.0	1989-1991	4WD	HB315x.669	D436		
Pickup	SR5	3.0	1989-1991	2WD	HB407x.602	D389		
Pickup	SR5	3.0	1994-1995	4WD	HB315x.669	D436		
Pickup		2.2	1976-1981		HB169x.560	D57		
Pickup		2.4	1981-1983		HB169x.560	D57		
Pickup		3.0	1988-1988		HB317x.591	D410		
Pickup		3.0	1989-1992	2WD	HB407x.602	D389		
Prius	Touring	1.5	2007-2008		HB493x.650	D990		
Prius		1.5	2001-2008		HB493x.650	D990		
Rav4	2-Door	2.0	1996-1997		HB310x.689	D562		
Rav4		2.0	1996-2000		HB310x.689	D562		
Rav4			2001-2005		HB429x.681	D862		
Sequoia	Limited	4.7	2005-2007		HB490x.665	D976	HB477x.610	D606
Sequoia	Limited	4.7	2008-2008		HB589x.704	D1303	HB590x.692	D1304
Sequoia	Limited	5.7	2008-2008		HB589x.704	D1303	HB590x.692	D1304
Sequoia	Platinum	5.7	2008-2008		HB589x.704	D1303	HB590x.692	D1304
Sequoia	SR5	4.7	2005-2007		HB490x.665	D976	HB477x.610	D606
Sequoia	SR5	4.7	2008-2008		HB589x.704	D1303	HB590x.692	D1304
Sequoia	SR5	5.7	2008-2008		HB589x.704	D1303	HB590x.692	D1304
Sequoia		4.7	2001-2002		HB314x.665	D812	HB477x.610	D606
Sequoia		4.7	2003-2004		HB490x.665	D976	HB477x.610	D606
Sienna		3.0	1998-2003		HB318x.669	D697		
Solara		2.2	1999-2001		HB320x.669	D707	HB401x.587	D325
Solara		2.4	2002-2003		HB320x.669	D707	HB401x.587	D325
Solara		3.0	1999-2003		HB320x.669	D707	HB401x.587	D325
Supra	Twin Turbo	3.0	1996-1998		HB215x.630	D629	HB216x.590	D630
Supra		3.0	1993-1998		HB375x.669	D619		
T100	SR5	3.0	1993-1994	4WD	HB311x.591	D611		
T100	SR5	3.4	1995-1995	4WD	HB311x.591	D611		
T100	SR5	3.4	1996-1997		HB311x.591	D611		

CODE Breakdown

HB 245 x .631

Insert Compound Code

Make/Model	Submodel	Engine (Liter)	Years	Note	FRONT		REAR	
					Hawk #	FMSI	Hawk #	FMSI
TOYOTA CONT.								
T100		2.7	1997-1998		HB311x.591	D611		
T100		3.0	1993-1993	4WD	HB311x.591	D611		
Tacoma	Pre Runner	2.7	2005-2008		HB490x.665	D976		
Tacoma	Pre Runner	4.0	2005-2008		HB490x.665	D976		
Tacoma	Regular Cab	2.4	1995-1997	4WD	HB315x.669	D436		
Tacoma	Regular Cab	2.4	1995-1997	2WD	HB407x.602	D389		
Tacoma	Regular Cab	2.7	1995-1997	4WD	HB315x.669	D436		
Tacoma	Regular Cab	2.7	1995-1997	2WD	HB407x.602	D389		
Tacoma	Regular Cab	3.4	1995-1997	4WD	HB315x.669	D436		
Tacoma	Regular Cab	3.4	1995-1997	2WD	HB407x.602	D389		
Tacoma	SR5	3.4	1995-1997	4WD	HB315x.669	D436		
Tacoma	X-Runner	4.0	2005-2008		HB490x.665	D976		
Tacoma		2.4	1995-1997	4WD	HB315x.669	D436		
Tacoma		2.4	1995-1997	2WD	HB407x.602	D389		
Tacoma		2.4	2003-2004	4WD	HB315x.669	D436		
Tacoma		2.4	2003-2004	2WD	HB407x.602	D389		
Tacoma		2.7	1995-2004	4WD	HB315x.669	D436		
Tacoma		2.7	1995-2004	2WD	HB407x.602	D389		
Tacoma		2.7	2008-2008		HB490x.665	D976		
Tacoma		3.4	1995-2004	4WD	HB315x.669	D436		
Tacoma		3.4	1995-2004	2WD	HB407x.602	D389		
Tacoma		4.0	2008-2008		HB490x.665	D976		
Tercel	CE	1.5	1997-1998		HB191x.590	D242		
Tercel	DLX	1.5	1983-1988		HB191x.590	D242		
Tercel	DLX	1.5	1990-1994		HB191x.590	D242		
Tercel	DX	1.5	1995-1996		HB191x.590	D242		
Tercel	EZ	1.5	1988-1988		HB191x.590	D242		
Tercel	EZ	1.5	1990-1990		HB191x.590	D242		
Tercel	LE	1.5	1991-1993		HB191x.590	D242		
Tercel	SR5	1.5	1983-1988		HB191x.590	D242		
Tercel	STD	1.5	1983-1983		HB191x.590	D242		
Tercel	STD	1.5	1986-1988		HB191x.590	D242		
Tercel		1.5	1984-1985		HB191x.590	D242		
Tercel		1.5	1989-1996		HB191x.590	D242		
Tundra	Limited	4.7	2005-2006		HB490x.665	D976		
Tundra	Limited	4.7	2007-2008		HB589x.704	D1303	HB590x.692	D1304
Tundra	Limited	5.7	2007-2008		HB589x.704	D1303	HB590x.692	D1304
Tundra	SR5	4.0	2005-2006		HB490x.665	D976		
Tundra	SR5	4.0	2007-2008		HB589x.704	D1303	HB590x.692	D1304
Tundra	SR5	4.7	2005-2005		HB409x.661	D507		
Tundra	SR5	4.7	2005-2006		HB490x.665	D976		
Tundra	SR5	4.7	2007-2008		HB589x.704	D1303	HB590x.692	D1304
Tundra	SR5	5.7	2007-2008		HB589x.704	D1303	HB590x.692	D1304
Tundra		3.4	2003-2003		HB314x.665	D812		
Tundra		3.4	2004-2004		HB490x.665	D976		
Tundra		4.0	2005-2006		HB490x.665	D976		
Tundra		4.0	2007-2008		HB589x.704	D1303	HB590x.692	D1304
Tundra		4.7	2003-2003		HB314x.665	D812		
Tundra		4.7	2004-2006		HB490x.665	D976		
Tundra		4.7	2007-2008		HB589x.704	D1303	HB590x.692	D1304
Tundra		5.7	2007-2008		HB589x.704	D1303	HB590x.692	D1304
Yaris	S	1.5	2008-2008		HB596x.690	D1184		
Yaris		1.5	2008-2008		HB596x.690	D1184		

RACE COMPOUND CODES

DTC-70 - U	DTC-05 - H	MT-4 - L	DR-97 - J
DTC-60 - G	HT-14 - V	Blue 9012 - E	HP Plus - N
DTC-30 - W	HT-10 - S	Black - M	

STREET COMPOUND CODES

HPS Performance Street - F	SuperDuty - P
Performance Ceramic - Z	
LTS Light Truck & SUV - Y	

Make/ Model	Submodel	Engine		Note	FRONT		REAR	
		(Liter)	Years		Hawk #	FMSI	Hawk #	FMSI
TRIUMPH								
TR7		2.0	1975-1980		HB123x.535	D61		
VOLKSWAGEN								
411		1.7	1971-1972		HB172x.595	D31		
412		1.7	1973-1974		HB172x.595	D31		
412		1.8	1974-1974		HB172x.595	D31		
Beetle	2.5	2.5	2006-2006		HB272x.763	D687		
Beetle	2.5	2.5	2006-2006	w/Wear Sensor	HB272x.763A	D687		
Beetle	GLS TDI	1.9	2005-2005		HB365x.728	D768	HB364x.642	D340
Beetle	S	2.5	2008-2008	w/288 mm Rotors	HB272x.763	D687		
Beetle	S	2.5	2008-2008	w/288 mm Rotors, w/Wear Sensor	HB272x.763A	D687		
Beetle	S	2.5	2008-2008	w/280 mm Rotors	HB365x.728	D768		
Beetle	SE	2.5	2008-2008	w/288 mm Rotors	HB272x.763	D687		
Beetle	SE	2.5	2008-2008	w/288 mm Rotors, w/Wear Sensor	HB272x.763A	D687		
Beetle	SE	2.5	2008-2008	w/280 mm Rotors	HB365x.728	D768		
Beetle	TDI	1.9	2006-2006		HB365x.728	D768		
Beetle		1.8	1999-2000		HB365x.728	D768	HB364x.642	D340
Beetle		1.8	2001-2002		HB272x.763	D687	HB364x.642	D340
Beetle		1.8	2001-2002	w/Wear Sensor	HB272x.763A	D687	HB364x.642	D340
Beetle		1.9	1998-2004		HB365x.728	D768	HB364x.642	D340
Beetle		2.0	1999-2005		HB272x.763	D687	HB364x.642	D340
Beetle		2.0	1999-2005	w/Wear Sensor	HB272x.763A	D687	HB364x.642	D340
Cabriolet		1.8	1985-1985		HB189x.595	D569		
Cabriolet		1.8	1986-1990		HB189x.550	D569		
Corrado	SLC	2.8	1992-1992		HB190x.730	D227		
Corrado	SLC	2.8	1992-1992	w/Wear Sensor	HB190x.730A	D227		
Corrado	SLC	2.8	1992-1993		HB190x.730	D227	HB364x.642	D340
Corrado	SLC	2.8	1992-1993	w/Wear Sensor	HB190x.730A	D227		
Corrado		1.8	1990-1992		HB190x.730	D227		
Corrado		1.8	1990-1992	w/Wear Sensor	HB190x.730A	D227		
Eos	Komfort	2.0	2008-2008		HB543x.760	D1107	HB544x.628	D1108
Eos	Lux	2.0	2008-2008		HB543x.760	D1107	HB544x.628	D1108
Eos	Turbo	2.0	2008-2008		HB543x.760	D1107	HB544x.628	D1108
Eos	VR6	3.2	2008-2008		HB543x.760	D1107	HB544x.628	D1108
Golf	GL	1.6	1987-1988		HB189x.595	D569		
Golf	GL	1.8	1987-1992		HB189x.595	D569		
Golf	GL	2.0	1995-1997		HB190x.600	D227		
Golf	GL	2.0	1995-1997	w/Wear Sensor	HB190x.600A	D227		
Golf	GL	2.0	1999-1999		HB190x.600	D227	HB364x.587	D340
Golf	GL	2.0	1999-1999	w/Wear Sensor	HB190x.600A	D227	HB364x.587	D340
Golf	GL	2.0	2006-2006		HB365x.728	D768	HB544x.628	D1108
Golf	GLS	2.0	2006-2006		HB365x.728	D768	HB544x.628	D1108
Golf	GLS TDI	1.9	2006-2006		HB365x.728	D768	HB544x.628	D1108
Golf	GLS TDI	1.9	2006-2006		HB543x.760	D1107	HB544x.628	D1108
Golf	GT	1.8	1987-1988		HB189x.595	D569		
Golf	GTi	1.8	1985-1986		HB189x.595	D569		
Golf	GTi	1.8	2004-2004		HB272x.763	D687	HB364x.587	D340
Golf	GTi	1.8	2004-2004	w/Wear Sensor	HB272x.763A	D687	HB364x.642	D340
Golf	GTi	2.0	1993-1993		HB190x.600	D227		
Golf	GTi	2.0	1993-1993	w/Wear Sensor	HB190x.600A	D227		
Golf	GTi	2.0	1994-1994		HB190x.730	D227	HB364x.587	D340
Golf	GTi	2.0	1994-1994	w/Wear Sensor	HB190x.730A	D227	HB364x.587	D340
Golf	GTi	2.0	1996-1999		HB190x.600	D227	HB364x.587	D340

CODE Breakdown

HB 245 x .631

Insert Compound Code

Make/Model	Submodel	Engine (Liter)	Years	Note	FRONT		REAR	
					Hawk #	FMSI	Hawk #	FMSI
VOLKSWAGEN CONT.								
Golf	GTi	2.0	1996-1999	w/Wear Sensor	HB190x.600A	D227	HB364x.587	D340
Golf	GTi	2.0	2006-2007		HB543x.760	D1107		
Golf	GTi	2.8	1999-2000		HB272x.763	D687	HB364x.587	D340
Golf	GTi	2.8	1999-2000	w/Wear Sensor	HB272x.763A	D687	HB364x.587	D340
Golf	GTi	2.8	2001-2001		HB272x.763	D687		
Golf	GTi	2.8	2001-2001	w/Wear Sensor	HB272x.763A	D687		
Golf	GTi	2.8	2002-2004		HB272x.763	D687	HB364x.642	D340
Golf	GTi	2.8	2002-2004	w/Wear Sensor	HB272x.763A	D687	HB364x.642	D340
Golf	GTi 1.8T	1.8	2006-2006		HB272x.763	D687	HB544x.628	D1108
Golf	GTi 1.8T	1.8	2006-2006	w/Wear Sensor	HB272x.763A	D687	HB544x.628	D1108
Golf	GTi 1.8T	1.8	2006-2006		HB543x.760	D1107	HB544x.628	D1108
Golf	GTi 16-Valve	1.8	1987-1987		HB189x.595	D569		
Golf	GTi 16-Valve	1.8	1988-1989		HB189x.550	D569	HB364x.587	D340
Golf	GTi 16-Valve	2.0	1990-1991		HB189x.550	D569	HB364x.587	D340
Golf	GTi 8-Valve	1.8	1990-1990		HB189x.550	D569	HB364x.587	D340
Golf	GTi 8-Valve	1.8	1991-1991		HB189x.550	D569		
Golf	GTi VR6	2.8	1995-1995		HB189x.595	D569		
Golf	GTi VR6	2.8	1995-1995		HB190x.600	D227	HB364x.587	D340
Golf	GTi VR6	2.8	1995-1995	w/Wear Sensor	HB190x.600A	D227	HB364x.587	D340
Golf	GTi VR6	2.8	1997-1998		HB272x.763	D687	HB364x.587	D340
Golf	GTi VR6	2.8	1997-1998	w/Wear Sensor	HB272x.763A	D687	HB364x.587	D340
Golf	III Celebration	2.0	1995-1995		HB190x.600	D227		
Golf	III Celebration	2.0	1995-1995	w/Wear Sensor	HB190x.600A	D227		
Golf	III City	2.0	1995-1995		HB190x.600	D227		
Golf	III City	2.0	1995-1995	w/Wear Sensor	HB190x.600A	D227		
Golf	III GL	2.0	1993-1994		HB190x.600	D227		
Golf	III GL	2.0	1993-1994	w/Wear Sensor	HB190x.600A	D227		
Golf	III Sport	2.0	1995-1995		HB190x.600	D227		
Golf	III Sport	2.0	1995-1995	w/Wear Sensor	HB190x.600A	D227		
Golf	Jazz	2.0	1997-1997		HB190x.600	D227		
Golf	Jazz	2.0	1997-1997	w/Wear Sensor	HB190x.600A	D227		
Golf	K2	2.0	1997-1998		HB190x.600	D227		
Golf	K2	2.0	1997-1998	w/Wear Sensor	HB190x.600A	D227		
Golf	R32	3.2	2004-2004		HB497x.776	D682		
Golf		1.6	1985-1986		HB189x.595	D569		
Golf		1.8	1985-1986		HB189x.595	D569		
Golf		1.8	1988-1989		HB189x.595	D569		
Golf		1.8	2000-2001		HB272x.763	D687	HB364x.587	D340
Golf		1.8	2000-2001	w/Wear Sensor	HB272x.763A	D687	HB364x.587	D340
Golf		1.9	2000-2001		HB365x.728	D768	HB364x.587	D340
Golf		1.9	2002-2004		HB365x.728	D768	HB364x.642	D340
Golf		2.0	1998-1998		HB190x.600	D227		
Golf		2.0	1998-1998	w/Wear Sensor	HB190x.600A	D227		
Golf		2.0	2000-2001		HB272x.763	D687	HB364x.587	D340
Golf		2.0	2000-2001	w/Wear Sensor	HB272x.763A	D687	HB364x.587	D340
Golf		2.0	2002-2004		HB272x.763	D687	HB364x.642	D340
Golf		2.0	2002-2004	w/Wear Sensor	HB272x.763A	D687	HB364x.642	D340
Jetta	2.0T	2.0	2006-2007		HB365x.728	D768	HB544x.628	D1108
Jetta	Carat	1.8	1988-1988		HB189x.595	D569		
Jetta	Carat	1.8	1990-1991		HB189x.595	D569		
Jetta	Deluxe	1.6	1981-1986		HB189x.595	D569		
Jetta	Deluxe	1.7	1981-1984		HB189x.595	D569		
Jetta	Deluxe	1.8	1984-1986		HB189x.595	D569		

RACE COMPOUND CODES

DTC-70 - U	DTC-05 - H	MT-4 - L	DR-97 - J
DTC-60 - G	HT-14 - V	Blue 9012 - E	HP Plus - N
DTC-30 - W	HT-10 - S	Black - M	

STREET COMPOUND CODES

HPS Performance Street - F	SuperDuty - P
Performance Ceramic - Z	
LTS Light Truck & SUV - Y	

Make/Model	Submodel	Engine (Liter)	Years	Note	FRONT		REAR	
					Hawk #	FMSI	Hawk #	FMSI
VOLKSWAGEN CONT.								
Jetta	GL	1.6	1986-1986		HB189x.595	D569		
Jetta	GL	1.6	1991-1992		HB189x.595	D569		
Jetta	GL	1.8	1991-1992		HB189x.595	D569		
Jetta	GL	1.8	2003-2003		HB365x.728	D768	HB364x.642	D340
Jetta	GL	2.0	1993-1994		HB190x.730	D227		
Jetta	GL	2.0	1993-1994	w/Wear Sensor	HB190x.730A	D227		
Jetta	GL	2.0	1996-1998		HB190x.600	D227		
Jetta	GL	2.0	1996-1998	w/Wear Sensor	HB190x.600A	D227		
Jetta	GL	2.0	2000-2001		HB365x.728	D768		
Jetta	GL	2.0	2002-2003		HB365x.728	D768	HB364x.642	D340
Jetta	GLi	1.8	1985-1985		HB189x.595	D569		
Jetta	GLi	1.8	1987-1987		HB189x.550	D569		
Jetta	GLi	2.0	2006-2007		HB365x.728	D768	HB544x.628	D1108
Jetta	Gli	2.0	2008-2008		HB543x.760	D1107	HB544x.628	D1108
Jetta	GLi 16-Valve	1.8	1987-1989		HB189x.550	D569		
Jetta	GLS	1.8	2000-2001		HB365x.728	D768	HB364x.587	D340
Jetta	GLS	1.8	2002-2004		HB365x.728	D768	HB364x.642	D340
Jetta	GLS	2.0	1996-1998		HB190x.600	D227	HB364x.587	D340
Jetta	GLS	2.0	1996-1998	w/Wear Sensor	HB190x.600A	D227	HB364x.587	D340
Jetta	GLS	2.0	1996-2001				HB364x.587	D340
Jetta	GLS	2.0	2000-2001		HB365x.728	D768	HB364x.587	D340
Jetta	GLS	2.0	2002-2004		HB365x.728	D768	HB364x.642	D340
Jetta	GLX	2.8	1996-1999		HB272x.763	D687	HB364x.587	D340
Jetta	GLX	2.8	1996-1999	w/Wear Sensor	HB272x.763A	D687	HB364x.587	D340
Jetta	III GL	2.0	1993-1995		HB190x.730	D227		
Jetta	III GL	2.0	1993-1995	w/Wear Sensor	HB190x.730A	D227		
Jetta	III GLS	2.0	1993-1995		HB190x.730	D227		
Jetta	III GLS	2.0	1993-1995	w/Wear Sensor	HB190x.730A	D227		
Jetta	S	2.5	2008-2008		HB543x.760	D1107	HB544x.628	D1108
Jetta	SE	2.5	2008-2008		HB543x.760	D1107	HB544x.628	D1108
Jetta	SEL	2.5	2008-2008		HB543x.760	D1107	HB544x.628	D1108
Jetta	TDI	1.9	2000-2001		HB365x.728	D768	HB364x.587	D340
Jetta	TDI	1.9	2002-2004		HB365x.728	D768	HB364x.642	D340
Jetta	TDI	1.9	2005-2006		HB365x.728	D768	HB544x.628	D1108
Jetta		1.6	1987-1987		HB189x.595	D569		
Jetta		1.6	1989-1989		HB189x.595	D569		
Jetta		1.8	1987-1989		HB189x.595	D569		
Jetta		2.0	1998-1998		HB190x.600	D227		
Jetta		2.0	1998-1998	w/Wear Sensor	HB190x.600A	D227		
Passat	4 Motion	1.8	2004-2004		HB354x.756	D840	HB364x.642	D340
Passat	4 Motion	1.8	2004-2004	w/Wear Sensor	HB354x.756A	D840	HB364x.642	D340
Passat	4 Motion	1.8	2005-2005		HB354x.756	D840	HB544x.628	D1108
Passat	4 Motion	1.8	2005-2005	w/Wear Sensor	HB354x.756A	D840	HB544x.628	D1108
Passat	4 Motion	2.8	2003-2004		HB354x.756	D840	HB364x.642	D340
Passat	4 Motion	2.8	2003-2004	w/Wear Sensor	HB354x.756A	D840	HB364x.642	D340
Passat	4 Motion	2.8	2005-2005		HB354x.756	D840	HB544x.628	D1108
Passat	4 Motion	2.8	2005-2005	w/Wear Sensor	HB354x.756A	D840	HB544x.628	D1108
Passat	4 Motion	4.0	2003-2004		HB354x.756	D840	HB364x.642	D340
Passat	4 Motion	4.0	2003-2004	w/Wear Sensor	HB354x.756A	D840	HB364x.642	D340
Passat	GL	2.0	1990-1991		HB190x.600	D227		
Passat	GL	2.0	1990-1991	w/Wear Sensor	HB190x.600A	D227		
Passat	GL	2.0	1992-1993	w/Syncro Ring	HB190x.600	D227	HB364x.587	D340
Passat	GL	2.0	1992-1993	w/Wear Sensor, w/Syncro Ring	HB190x.600A	D227	HB364x.587	D340

CODE Breakdown

HB 245 x .631

Insert Compound Code

Make/Model	Submodel	Engine (Liter)	Years	Note	FRONT		REAR	
					Hawk #	FMSI	Hawk #	FMSI
VOLKSWAGEN CONT.								
Passat	GL	2.0	1992-1993		HB190x.730	D227	HB364x.587	D340
Passat	GL	2.0	1992-1993	w/Syncro Ring	HB190x.730	D227	HB364x.587	D340
Passat	GL	2.0	1992-1993	w/Wear Sensor	HB190x.730A	D227	HB364x.587	D340
Passat	GL	2.0	1992-1993	w/Wear Sensor, w/Syncro Ring	HB190x.730A	D227	HB364x.587	D340
Passat	GLS	1.8	1998-1998		HB269x.763	D555		
Passat	GLS	1.8	1998-1998	w/Oval Wear Sensor	HB269x.763A	D555		
Passat	GLS	1.8	1998-1998	w/Large Round Wear Sensor	HB269x.763B	D555		
Passat	GLS	2.0	1995-1995	w/Syncro Ring	HB190x.600	D227		
Passat	GLS	2.0	1995-1995	w/Wear Sensor, w/Syncro Ring	HB190x.600A	D227		
Passat	GLS	2.0	1995-1995	w/Syncro Ring	HB190x.730	D227		
Passat	GLS	2.0	1995-1995	w/Wear Sensor, w/Syncro Ring	HB190x.730A	D227		
Passat	GLS	2.0	1995-1996		HB190x.730	D227	HB364x.587	D340
Passat	GLS	2.0	1995-1996	w/Wear Sensor	HB190x.730A	D227	HB364x.587	D340
Passat	GLS	2.0	1996-1996	w/Syncro Ring	HB190x.600	D227		
Passat	GLS	2.0	1996-1996	w/Wear Sensor, w/Syncro Ring	HB190x.600A	D227		
Passat	GLS	2.8	1998-1998		HB272x.763	D687		
Passat	GLS	2.8	1998-1998	w/Wear Sensor	HB272x.763A	D687		
Passat	GLS 4 Motion	2.8	2002-2002		HB354x.756	D840	HB364x.642	D340
Passat	GLS 4 Motion	2.8	2002-2002	w/Wear Sensor	HB354x.756A	D840	HB364x.642	D340
Passat	GLX	2.8	1993-1995	w/Syncro Ring	HB190x.600	D227	HB364x.587	D340
Passat	GLX	2.8	1993-1995	w/Wear Sensor, w/Syncro Ring	HB190x.600A	D227	HB364x.587	D340
Passat	GLX	2.8	1997-1997		HB354x.756	D840	HB364x.587	D340
Passat	GLX	2.8	1997-1997	w/Wear Sensor	HB354x.756A	D840	HB364x.587	D340
Passat	GLX 4 Motion	2.8	2002-2002		HB354x.756	D840	HB364x.642	D340
Passat	GLX 4 Motion	2.8	2002-2002	w/Wear Sensor	HB354x.756A	D840	HB364x.642	D340
Passat	Komfort	2.0	2008-2008		HB543x.760	D1107	HB544x.628	D1108
Passat	Lux	2.0	2008-2008		HB543x.760	D1107	HB544x.628	D1108
Passat	TDI	1.9	1996-1997	w/Syncro Ring	HB190x.600	D227		
Passat	TDI	1.9	1996-1997	w/Wear Sensor, w/Syncro Ring	HB190x.600A	D227		
Passat	Turbo	2.0	2008-2008		HB543x.760	D1107	HB544x.628	D1108
Passat	VR6	3.6	2008-2008		HB543x.760	D1107	HB544x.628	D1108
Passat		1.8	1999-1999		HB269x.763	D555	HB364x.642	D340
Passat		1.8	1999-1999	w/Oval Wear Sensor	HB269x.763A	D555	HB364x.642	D340
Passat		1.8	1999-1999	w/Large Round Wear Sensor	HB269x.763B	D555	HB364x.642	D340
Passat		1.8	2000-2001		HB354x.756	D840	HB364x.642	D340
Passat		1.8	2000-2001	w/Wear Sensor	HB354x.756A	D840	HB364x.642	D340
Passat		2.8	1999-1999		HB272x.763	D687	HB364x.642	D340
Passat		2.8	1999-1999	w/Wear Sensor	HB272x.763A	D687	HB364x.642	D340
Passat		2.8	2000-2001		HB354x.756	D840	HB364x.642	D340
Passat		2.8	2000-2001	w/Wear Sensor	HB354x.756A	D840	HB364x.642	D340
Quantum	Custom	1.6	1983-1983		HB189x.595	D569		
Quantum	Custom	1.7	1982-1983		HB189x.595	D569		
Quantum	Custom	2.2	1983-1983		HB189x.595	D569		
Quantum	DLX	1.6	1982-1983		HB189x.595	D569		
Quantum	DLX	1.7	1982-1983		HB189x.595	D569		
Quantum	GL Custom	1.6	1984-1985		HB189x.595	D569		
Quantum	GL Custom	1.8	1984-1985		HB189x.595	D569		
Quantum	GL Custom	2.2	1984-1986		HB189x.595	D569		
Quantum	GL Deluxe	1.6	1984-1984		HB189x.595	D569		
Quantum	GL Deluxe	1.8	1984-1984		HB189x.595	D569		
Quantum	GL Deluxe	2.2	1984-1984		HB189x.595	D569		
Quantum	Syncro	2.2	1986-1988	w/Wear Sensor	HB190x.730A	D227	HB364x.587	D340
Quantum	Wolfsburg	2.2	1984-1984		HB189x.595	D569		

RACE COMPOUND CODES

DTC-70 - U | DTC-05 - H | MT-4 - L | DR-97 - J
 DTC-60 - G | HT-14 - V | Blue 9012 - E | HP Plus - N
 DTC-30 - W | HT-10 - S | Black - M

STREET COMPOUND CODES

HPS Performance Street - F | SuperDuty - P
 Performance Ceramic - Z
 LTS Light Truck & SUV - Y

Make/Model	Submodel	Engine		Note	FRONT		REAR	
		(Liter)	Years		Hawk #	FMSI	Hawk #	FMSI
VOLKSWAGEN CONT.								
Quantum		1.6	1985-1985		HB189x.595	D569		
Quantum		1.8	1985-1985		HB189x.595	D569		
Quantum		2.2	1985-1985		HB189x.595	D569		
R32		3.2	2008-2008		HB515x.760	D915	HB544x.628	D1108
Rabbit	GL DLX	1.6	1983-1983		HB189x.595	D569		
Rabbit	GL DLX	1.7	1983-1983		HB189x.595	D569		
Rabbit	GTi Sport	1.7	1983-1983		HB189x.595	D569		
Rabbit	GTi Sport	1.8	1983-1983		HB189x.595	D569		
Rabbit	L	1.6	1983-1984		HB189x.595	D569		
Rabbit	L	1.7	1983-1984		HB189x.595	D569		
Rabbit	L Custom	1.6	1981-1982		HB189x.595	D569		
Rabbit	L Custom	1.7	1982-1982		HB189x.595	D569		
Rabbit	LS Custom	1.6	1983-1983		HB189x.595	D569		
Rabbit	LS Custom	1.7	1983-1983		HB189x.595	D569		
Rabbit	LS Deluxe	1.6	1981-1982		HB189x.595	D569		
Rabbit	LS Deluxe	1.7	1982-1982		HB189x.595	D569		
Rabbit	S	2.5	2008-2008		HB543x.760	D1107	HB544x.628	D1108
Rabbit		1.5	1979-1980		HB189x.595	D569		
Rabbit		1.6	1980-1980		HB189x.595	D569		
Rabbit		1.7	1981-1982		HB189x.595	D569		
Rabbit		1.8	1984-1984		HB189x.595	D569		
Rabbit Convertible		1.6	1980-1980		HB189x.595	D569		
Rabbit Convertible		1.7	1981-1983		HB189x.595	D569		
Rabbit Convertible		1.8	1984-1984		HB189x.595	D569		
Scirocco	16-Valve	1.8	1987-1987		HB189x.550	D569		
Scirocco	16-Valve	1.8	1987-1988	w/Wear Sensor	HB190x.730A	D227	HB364x.587	D340
Scirocco		1.6	1979-1980		HB189x.595	D569		
Touareg	TDI	4.9	2004-2004	18 in. Wheel, w/350 mm Rotors	HB501x.625	D1014	HB502x.606	D978
Touareg	TDI	4.9	2004-2004	w/330 mm Rotors	HB512x.605	D1007	HB502x.606	D978
Touareg	TDI	5.0	2006-2006	w/350 mm Rotors	HB501x.625	D1014	HB502x.606	D978
Touareg	TDI	5.0	2006-2006	w/330 mm Rotors	HB512x.605	D1007	HB502x.606	D978
Touareg	TDI	5.0	2007-2007		HB512x.605	D1007	HB502x.606	D978
Touareg	TDI	5.0	2008-2008		HB501x.625	D1014	HB502x.606	D978
Touareg		3.2	2004-2005	18 in. Wheel, w/350 mm Rotors	HB501x.625	D1014		
Touareg		3.2	2004-2006	w/330 mm Rotors	HB512x.605	D1007	HB502x.606	D978
Touareg		3.2	2006-2006	w/350 mm Rotors	HB501x.625	D1014	HB502x.606	D978
Touareg		3.6	2006-2006	w/350 mm Rotors	HB501x.625	D1014	HB502x.606	D978
Touareg		3.6	2006-2006	w/330 mm Rotors	HB512x.605	D1007	HB502x.606	D978
Touareg		3.6	2007-2007		HB512x.605	D1007	HB502x.606	D978
Touareg		4.2	2004-2005	18 in. Wheel, w/350 mm Rotors	HB501x.625	D1014	HB502x.606	D978
Touareg		4.2	2004-2006	w/330 mm Rotors	HB512x.605	D1007	HB502x.606	D978
Touareg		4.2	2006-2006	w/350 mm Rotors	HB501x.625	D1014	HB502x.606	D978
Touareg		4.2	2007-2007		HB512x.605	D1007	HB502x.606	D978
Transporter	211	1.6	1971-1972		HB171x.590	D45		
Transporter	211	1.7	1972-1973		HB171x.590	D45		
Transporter	211	1.8	1974-1974		HB171x.590	D45		
Transporter	215	1.6	1971-1972		HB171x.590	D45		
Transporter	215	1.7	1972-1973		HB171x.590	D45		
Transporter	261	1.6	1971-1971		HB171x.590	D45		
Transporter	265	1.6	1971-1971		HB171x.590	D45		
Transporter		1.6	1971-1972		HB171x.590	D45		
Transporter		1.7	1972-1973		HB171x.590	D45		
Transporter		1.8	1974-1975		HB171x.590	D45		

CODE Breakdown

HB 245 x .631

Insert Compound Code

Make/Model	Submodel	Engine (Liter)	Years	Note	FRONT		REAR	
					Hawk #	FMSI	Hawk #	FMSI
VOLKSWAGEN								
Transporter		2.0	1976-1979		HB171x.590	D45		
Vanagon	Campmobile	1.6	1982-1983		HB171x.590	D45		
Vanagon	Campmobile	1.9	1983-1985		HB171x.590	D45		
Vanagon	Campmobile	2.0	1980-1983		HB171x.590	D45		
Vanagon	Kombi	2.0	1980-1981		HB171x.590	D45		
Vanagon	Transport	2.0	1981-1981		HB171x.590	D45		
Vanagon		1.6	1982-1985		HB171x.590	D45		
Vanagon		1.9	1983-1985		HB171x.590	D45		
Vanagon		2.0	1982-1983		HB171x.590	D45		
VOLVO								
142	E	2.0	1971-1972		HB204x.615	D43		
142	GL	2.0	1974-1974		HB204x.615	D43		
142	S	2.0	1969-1969		HB204x.615	D43		
142		2.0	1970-1974		HB204x.615	D43		
145	S	2.0	1969-1969		HB204x.615	D43		
145		2.0	1971-1974		HB204x.615	D43	HB172x.595	D31
164	E	3.0	1973-1974		HB204x.615	D43	HB172x.595	D31
164		3.0	1972-1972		HB204x.615	D43	HB172x.595	D31
164		3.0	1975-1975		HB204x.615	D43	HB172x.595	D31
240	DL	2.3	1990-1990		HB204x.615	D43	HB172x.595	D31
240	GL	2.3	1992-1992		HB204x.615	D43	HB172x.595	D31
240	SE	2.3	1991-1991		HB204x.615	D43	HB172x.595	D31
240		2.3	1990-1993		HB204x.615	D43	HB172x.595	D31
242	GL	2.0	1975-1975		HB204x.615	D43	HB172x.595	D31
242		2.1	1976-1978		HB204x.615	D43	HB172x.595	D31
244	GL	2.0	1975-1975		HB204x.615	D43	HB172x.595	D31
244		2.1	1976-1978		HB204x.615	D43	HB172x.595	D31
245		2.0	1975-1975		HB204x.615	D43	HB172x.595	D31
245		2.1	1976-1978		HB204x.615	D43	HB172x.595	D31
262	C	2.7	1979-1979		HB204x.615	D43	HB172x.595	D31
262	GL	2.7	1976-1976		HB204x.615	D43	HB172x.595	D31
265	GL	2.7	1977-1978		HB204x.615	D43	HB172x.595	D31
265		2.7	1976-1976		HB204x.615	D43	HB172x.595	D31
740	SE	2.3	1991-1991		HB413x.690	D542		
740		2.3	1991-1992		HB413x.690	D542		
850	GLT	2.4	1995-1997		HB492x.732	D618		
850	R	2.3	1997-1997		HB492x.732	D618		
850	T-5	2.3	1997-1997		HB492x.732	D618		
850	T-5R	2.3	1995-1995		HB492x.732	D618		
850	Turbo	2.3	1995-1996		HB492x.732	D618		
850		2.3	1994-1994		HB492x.732	D618	HB172x.595	D31
850		2.3	1996-1996		HB492x.732	D618	HB172x.595	D31
850		2.4	1993-1997		HB492x.732	D618	HB172x.595	D31
940	GLE	2.3	1991-1991		HB413x.690	D542		
940	SE	2.3	1991-1991		HB413x.690	D542		
940		2.3	1991-1993		HB413x.690	D542		
1800	E	2.0	1970-1972		HB204x.615	D43		
1800	ES	2.0	1972-1973		HB204x.615	D43		
C30	T5	2.5	2008-2008		HB519x.682	D1044	HB478x.605	D1095
C70	T5	2.5	2006-2006		HB519x.682	D1044	HB478x.605	D1095
C70	T5	2.5	2008-2008		HB519x.682	D1044	HB478x.605	D1095
C70		2.3	1999-2002		HB492x.732	D618	HB172x.595	D31

RACE COMPOUND CODES

DTC-70 - U | DTC-05 - H | MT-4 - L | DR-97 - J
 DTC-60 - G | HT-14 - V | Blue 9012 - E | HP Plus - N
 DTC-30 - W | HT-10 - S | Black - M

STREET COMPOUND CODES

HPS Performance Street - F | SuperDuty - P
 Performance Ceramic - Z
 LTS Light Truck & SUV - Y

Make/Model	Submodel	Engine		Note	FRONT		REAR	
		(Liter)	Years		Hawk #	FMSI	Hawk #	FMSI
VOLVO CONT.								
C70		2.4	1999-2002		HB492x.732	D618	HB172x.595	D31
S40	2.4i	2.4	2006-2007		HB519x.682	D1044		
S40	2.4i	2.4	2008-2008		HB519x.682	D1044	HB478x.605	D1095
S40	i	2.4	2004-2004		HB500x.645	D837		
S40	i	2.4	2005-2005		HB194x.570	D592	HB478x.605	D1095
S40	T5	2.5	2004-2004		HB500x.645	D837	HB516x.626	D838
S40	T5	2.5	2005-2005		HB194x.570	D592	HB478x.605	D1095
S40	T5	2.5	2006-2008		HB519x.682	D1044	HB478x.605	D1095
S40		1.9	2000-2004		HB500x.645	D837	HB516x.626	D838
S60	2.4	2.4	2005-2005		HB491x.693	D794		
S60	2.5T	2.5	2005-2007		HB491x.693	D794		
S60	2.5T AWD	2.5	2005-2005		HB491x.693	D794		
S60	R	2.5	2004-2007		HB453x.585	D1001	HB194x.570	D592
S60	T5	2.4	2008-2008		HB491x.693	D794		
S60		2.3	2001-2001		HB491x.693	D794		
S60		2.4	2001-2004		HB491x.693	D794		
S60		2.5	2003-2004		HB491x.693	D794		
S70		2.3	1999-2000		HB492x.732	D618	HB172x.595	D31
S70		2.4	1999-2000		HB492x.732	D618	HB172x.595	D31
S80	2.5T	2.5	2004-2006		HB491x.693	D794		
S80	2.5T AWD	2.5	2004-2006		HB491x.693	D794		
S80	T6	2.9	2005-2005		HB491x.693	D794		
S80	T6 Premier	2.9	2005-2005		HB491x.693	D794		
S80		2.8	1999-2001		HB491x.693	D794		
S80		2.9	1999-2004		HB491x.693	D794		
V40		1.9	2000-2004		HB500x.645	D837	HB516x.626	D838
V50	2.4i	2.4	2006-2008		HB519x.682	D1044	HB478x.605	D1095
V50	i	2.4	2005-2005		HB519x.682	D1044	HB478x.605	D1095
V50	T5	2.5	2005-2008		HB519x.682	D1044	HB478x.605	D1095
V70	2.4	2.4	2005-2007		HB491x.693	D794		
V70	2.5T	2.5	2005-2007		HB491x.693	D794		
V70	R	2.5	2004-2006		HB453x.585	D1001	HB194x.570	D592
V70	R	2.5	2007-2007		HB453x.585	D1001		
V70	T5	2.3	2002-2002		HB491x.693	D794		
V70	X/C	2.4	2001-2002		HB491x.693	D794		
V70	X/C AWD	2.4	1999-2000		HB492x.732	D618		
V70		2.3	1999-2000		HB492x.732	D618	HB172x.595	D31
V70		2.3	2001-2001		HB491x.693	D794	HB172x.595	D31
V70		2.4	1999-2000		HB492x.732	D618	HB172x.595	D31
V70		2.4	2001-2004		HB491x.693	D794	HB172x.595	D31
V70		2.5	2003-2004		HB491x.693	D794	HB172x.595	D31
XC70		2.5	2003-2003		HB491x.693	D794	HB172x.595	D31
XC70		2.5	2004-2007		HB491x.693	D794		
XC90	2.5T	2.5	2005-2006		HB466x.780	D1003		
XC90	T6	2.9	2005-2005		HB466x.780	D1003		
XC90	V8	4.4	2005-2007		HB466x.780	D1003		
XC90	V8 Sport	4.4	2007-2007		HB466x.780	D1003		
XC90		2.5	2003-2004		HB466x.780	D1003		
XC90		2.9	2003-2004		HB466x.780	D1003		

MFG	CALIPER	PAD
Aerospace Components	2 Piston	HB104x.485
Aerospace Components	4 Piston	HB100x.480
Aerospace Components	GT	HB101x.800
Aerospace Components	Single Floater	HB104x.485
Alcon	4R-Type	HB118x.560
Alcon	B-Type	HB105x.775
Alcon	CAR22 48mm Radial Depth	HB351x.620
Alcon	CAR89 51mm Radial Depth	HB122x.710
Alcon	CAR94	HB331x1.17
Alcon	CAR95	HB349x1.18
Alcon	DP88	HB349x1.18
Alcon	F-type	HB106
Alcon	H-Type	HB192x.620
Alcon	L-Type	HB167x.778
Alcon	MB4	HB105x.775
Alcon	R-Type	HB118x.560
Alcon	TA-4	HB184x.650
Alcon	TA-4	HB184x.710
Alcon	TA-6	HB109x.710
Alcon	TA-6+	HB349x1.18
Alcon	TPC	HB221x1.18
Alcon	XF-Type	HB106
Alcon	XF-Type (Scalloped)	HB224x1.12
Alcon	XR-6	HB109x1.12
Alcon	XT	HB238x1.18
Alcon	XT-4	HB238x1.18
Alcon	XT-6	HB238x1.18
AP Racing	CP2279	HB110x.775
AP Racing	CP2361	HB107x.620
AP Racing	CP2485	HB108x.560
AP Racing	CP2505	HB117x.380
AP Racing	CP2561	HB108x.560
AP Racing	CP2576	HB108x.560
AP Racing	CP2577	HB108x.560
AP Racing	CP3176	HB108x.560
AP Racing	CP3177	HB108x.560
AP Racing	CP3178	HB108x.560

MFG	CALIPER	PAD
AP Racing	CP3228	HB107x.620
AP Racing	CP3307	HB110x.654
AP Racing	CP3676	HB108x.560
AP Racing	CP3677	HB108x.560
AP Racing	CP3696	HB117x.380
AP Racing	CP3788	HB110x.775
AP Racing	CP3789	HB110x.775
AP Racing	CP4567	HB192x.620
AP Racing	CP4586	HB108x.560
AP Racing	CP4596	HB108x.560
AP Racing	CP5020	HB108x.560
AP Racing	CP5040-10/11/12/13S4	HB192x.620
AP Racing	CP5040-20/21/22/23S4	HB114x.980
AP Racing	CP5040-30/31/32/33S4	HB114x.980
AP Racing	CP5060-10/11/12/13ST	HB122x.710
AP Racing	CP5060-2/3/4/5ST	HB109x.710
AP Racing	CP5100	HB192x.620
AP Racing	CP5104	HB107x.620
AP Racing	CP5108	HB192x.620
AP Racing	CP5144	HB107x.620
AP Racing	CP5211	HB108x.560
AP Racing	CP5311	HB108x.560
AP Racing	CP5510	HB167x.778
AP Racing	CP5515	HB167x.778
AP Racing	CP5555	HB109x.710
AP Racing	CP5570	HB122x.710
AP Racing	CP5610	HB167x.778
AP Racing	CP5810	HB109x.980
AP Racing	CP5835	HB110x.775
AP Racing	CP5842	HB331x1.17
AP Racing	CP5880	HB110x.775
AP Racing	CP5890	HB109x.980
AP Racing	CP6120	HB171x.590
AP Racing	CP6121	HB171x.590
AP Racing	CP6760	HB192x.620
AP Racing (Essex)	CP4751 (SC200)	HB101x.800
AP Racing (Essex)	CP4761 (SC200)	HB101x.800

MFG	CALIPER	PAD
AP Racing (Essex)	CP5200 (SC250)	HB110x.654
AP Racing (Essex)	CP5260 (SC660)	HB109x.980
AP Racing (Essex)	CP5270 (SC670)	HB109x.980
AP Racing (Essex)	CP5410 (SC240)	HB167x.778
AP Racing (Essex)	CP5751 (SC300)	HB101x.800
AP Racing (Essex)	CP5755 (SC100)	HB237x.625
AP Racing (Essex)	CP5756 (SC100)	HB237x.625
AP Racing (Essex)	CP5757 (SC100)	HB237x.625
AP Racing (Essex)	CP5805 (SC360/560)	HB102x.800
AP Racing (Essex)	CP5810 (SC660)	HB109x1.12
AP Racing (Essex)	CP5820 (SC680)	HB331x1.17
AP Racing (Essex)	CP5830 (SC430)	HB110x.775
AP Racing (Essex)	CP5850 (SC675)	HB221x1.10
AP Racing (Essex)	CP5890 (SC670)	HB109x1.12
AP Racing (Essex)	CP6751 (SC275)	HB101x.800
AP Racing (Essex)	CP6761 (SC275)	HB101x.800
AP Racing (Essex)	CP7751 (SC400)	HB101x.800
Baer	Alumisport	HB509x.678
Baer	GT	HB247x.575
Baer	GT Plus	HB247x.575
Baer	Sport (Front)	HB111x.610
Baer	Sport (Rear)	HB112x.540
Baer	SS (Front)	HB111x.610
Baer	SS (Rear)	HB112x.540
Baer	Track (Front)	HB111x.610
Baer	Track (Rear)	HB112x.540
Brakeman	F1 Tornado	HB117x.380
Brakeman	F2 Tornado	HB108x.560
Brakeman	F3 Tornado	HB100x.480
Brakeman	F3 Tornado	HB100x.625
Brakeman	F4 Tornado	HB101x.800
Brakeman	Replacement Metric Style Caliper	HB119x.594
Brembo	20.5272.12/22	HB194x.570
Brembo	20.7958.10/20	HB186x.854
Brembo	20.7958.30/40	HB168x.770
Brembo	20.8271.10/40	HB130x1.018
Brembo	20.8330.10/20	HB130x1.018

MFG	CALIPER	PAD
Brembo	20.8330.30/40	HB130x1.097
Brembo	20.8643.23/28/29	HB193x.670
Brembo	20.8644.10/22/23	HB193x.670
Brembo	Big Red	HB184x.650
Brembo	GT3R 4 Piston	HB184x.710
Brembo	NASCAR Front	HB221x1.18
Brembo	NASCAR Front	HB331x1.17
Brembo	NASCAR Rear	HB167x.778
Brembo	S4	HB141x.650
Brembo	X2.023.21/24	HB130x.775
Brembo	X2.028.01/04	HB130x.775
Brembo	X2.029.21/24	HB167x.778
Brembo	X2.029.71/74	HB167x.778
Brembo	X2.040.01/04	HB351x.620
Brembo	X6.059.41/44	HB167x.778
Brembo	X6.L4.01/04	HB331x1.17
Brembo	X9.011.01/04	HB167x.778
Brembo	X9.011.31/34	HB167x.778
Brembo	X9.060.51/54	HB130x1.018
Brembo	X9.060.71/74	HB130x.980
Brembo	X9.066.91/94	HB351x.620
Brembo	X93.41.21/24	HB186x.770
Brembo	X93.45.11/14	HB221x1.18
Brembo	X94.75.11/14	HB351x.620
Brembo	X96.14.01/04	HB167x.778
Brembo	X97.24.01	HB172x.595
Brembo	X97.24.10	HB172x.595
Brembo	X97.24.21	HB172x.595
Brembo	X97.24.31	HB172x.595
Brembo	X97.24.51	HB172x.595
Brembo	X97.24.61	HB172x.595
Brembo	X97.60.21/24	HB168x.770
Brembo	X97.60.41/44	HB105x.620
Brembo	X97.60.81/84	HB105x.620
Brembo	X98.A8.41/44	HB105x.620
Brembo	X98.A8.41/44	HB208x.620
Brembo	XA0.80.51/54	HB105x.708

MFG	CALIPER	PAD
Brembo	XA0.80.51/54	HB208x.708
Brembo	XA1.37.11/14	HB208x.708
Brembo	XA2.30.11/14	HB167x.620
Brembo	XA2.30.21/24	HB167x.620
Brembo	XA2.86.31/34	HB167x.620
Brembo	XA2.86.83/84	HB348x1.14
Brembo	XA2.E5.01/04	HB105x.775
Brembo	XA2.E5.01/04	HB208x.787
Brembo	XA2.E5.11/14	HB105x.775
Brembo	XA2.E5.11/14	HB208x.787
Brembo	XA2.E6.11/14	HB105x.620
Brembo	XA2.E6.11/14	HB208x.620
Brembo	XA2.E6.31/34	HB105x.620
Brembo	XA2.E6.31/34	HB208x.620
Brembo	XA2.E6.51/54	HB105x.620
Brembo	XA2.E7.01/04	HB105x.980
Brembo	XA2.E7.11/14	HB105x.980
Brembo	XA3.02.11/12	HB348x1.14
Brembo	XA3.02.21/22	HB348x1.14
Brembo	XA3.02.31/32	HB348x1.14
Brembo	XA3.02.41/42	HB348x1.14
Brembo	XA3.A4.01/04	HB167x.778
Brembo	XA3.A4.41/44	HB167x.778
Brembo	XA3.B7.51/54	HB348x1.14
Brembo	XA3.G2.11/14	HB167x.778
Brembo	XA4.10.01/04	HB351x.620
Brembo	XA4.67.51/54	HB208x.866
Brembo	XA4.C6.11/14	HB208x.866
Brembo	XA4.D3.01/04	HB130x.980
Brembo	XA4.F1.01/02	HB348x1.14
Brembo	XA4.F1.11/12	HB348x1.14
Brembo	XA4.F1.21/22	HB348x1.14
Brembo	XA4.F1.31/32	HB348x1.14
Brembo	XA5.09.01/04	HB208x.708
Brembo	XA5.90.01/04	HB105x.775
Brembo	XA5.C2.01/02	HB348x1.14
Brembo	XA6.61.01/04	HB348x1.14

MFG	CALIPER	PAD
Brembo	XA6.H7.01/02	HB348x1.14
Brembo	XA6.H7.11/14	HB105x.775
CNC	623	HB104x.485
CNC	624	HB100x.480
CNC	625	HB100x.480
CNC	626	HB100x.480
CNC	627	HB101x.800
CNC	630	HB102x.800
CNC	631	HB102x.800
CNC	633	HB102x.800
CNC	636	HB101x.800
CNC	642	HB100x.480
CNC	643	HB100x.480
CNC	644	HB104x.485
CNC	645	HB104x.485
CNC	648	HB100x.480
CNC	651	HB104x.485
CNC	652	HB104x.485
CNC	654	HB101x.800
CNC	664	HB100x.480
CNC	672	HB104x.485
CNC	674	HB100x.480
Coleman	GM Metric	HB119x.594
Coleman	Series I	HB101x.800
Coleman	Series II	HB101x.800
Coleman	Series III	HB105x.708
Coleman	Series III	HB105x.775
Coleman	Series III	HB105x.980
Coleman	Series IV	HB109x.710
Coleman	Series IV	HB109x.980
Coleman	Series IV	HB109x1.12
Mark Williams	81100	HB237x.625
Mark Williams	82100	HB237x.480
Mark Williams	83100	HB104x.485
Outlaw	1000	HB104x.485
Outlaw	2000	HB100x.480
Outlaw	2800	HB237x.625

MFG	CALIPER	PAD
Outlaw	3000	HB101x.800
Outlaw	4000	HB101x.800
Outlaw	4000XD	HB101x.800
Outlaw	GM	HB103x.590
Outlaw	Inboard Sprint Car Caliper	HB237x.625
Outlaw	M-16	HB237x.625
Red Devil	300 Series	HB101x.800
Red Devil	600 Series - Short Track	HB238x1.18
Red Devil	Single Piston Floter	HB104x.485
Sierra / JFZ	GM Series	HB103x.590
Sierra / JFZ	GN Series	HB102x.800
Sierra / JFZ	MGN Dual	HB100x.480
Sierra / JFZ	MGN Single	HB104x.485
Sierra / JFZ	XL Series	HB101x.800
Stop Tech	ST-10	HB405x.543
Stop Tech	ST-20	HB266x.650
Stop Tech	ST-22	HB180x.560
Stop Tech	ST-40	HB141x.650
Stop Tech	ST-45	HB122x.710
Stop Tech	ST-50	HB141x.650
Stop Tech	ST-60	HB122x.710
Strange	2 Piston	HB104x.485
Strange	4 Piston - Cotter Pin	HB100x.480
US Brake	DL Single	HB104x.485
US Brake	F22i	HB237x.480
US Brake	F22i	HB237x.625
US Brake	F33i	HB100x.480
US Brake	F88i	HB101x.800
US Brake	Oversize Metric GM	HB119x.594
US Brake	Standard GM	HB103x.590
US Brake	Stock Metric GM	HB119x.594
Wilwood	BDL w/ Bridgebolt	HB541x.490
Wilwood	BDL w/ Cotter pin	HB540x.490
Wilwood	DLSF	HB104x.485
Wilwood	Dynalite	HB100x.480
Wilwood	Dynalite Single	HB104x.485
Wilwood	Superlite 6R	HB521x.800

MFG	CALIPER	PAD
Wilwood	Superlite 4R	HB521x.800
Wilwood	Superlite ST	HB521x.800
Wilwood	Superlite SL4R	HB521x.800
Wilwood	IR-GTR4	HB351x.778
Wilwood	Forged Dynalite w/cotter pin	HB540x.490
Wilwood	Billet Radial Narrow Dynalite	HB541x.630
Wilwood	Billet Dynalite w/bridge bolt	HB541x.490
Wilwood	Billet Narrow Dynalite	HB541x.630
Wilwood	Dynapro Lug Mount Forged Billet	HB542x.490
Wilwood	Dynapro Radial Mount Billet	HB542x.600
Wilwood	Dynapro Narrow Mount	HB542x.600
Wilwood	Dynalite w/ Bridgebolt	HB237x.480
Wilwood	Dynalite w/ Bridgebolt	HB237x.625
Wilwood	DynaPro Lug Mount	HB542x.490
Wilwood	DynaPro NDL	HB542x.600
Wilwood	FDL	HB540x.490
Wilwood	GM Metric	HB119x.594
Wilwood	GMII, GM III	HB103x.590
Wilwood	GNIII	HB102x.800
Wilwood	GT 6000 - Radius	HB224x1.12
Wilwood	GT III - Radius	HB224x1.12
Wilwood	GT4000	HB105x.708
Wilwood	Integra HP	HB221x1.10
Wilwood	Integra IP	HB130x.980
Wilwood	Integra LP	HB369x.980
Wilwood	IR-GT	HB351x.620
Wilwood	IR-GT	HB351x.778
Wilwood	LC-GT	HB101x.800
Wilwood	NDL	HB541x.630
Wilwood	Prolite	HB238x1.18
Wilwood	Superlite II, III LC-GT	HB101x.800
Wilwood	Superlite-4/6, Forged	HB521x.800
Wilwood	Superlite-4/6, Forged, Thin	HB521x.650



CODE Breakdown

HB 245 x .631

Hawk Pad Shape

Overall Thickness
(in inches)

Hawk Performance Brake Pads

Insert Compound Code

Street Compounds

BRAKE PAD	COMPOUND CODE
HPS Performance Street	F
Performance Ceramic	Z
LTS Light Truck & SUV	Y
SuperDuty	P

Motorsports Compounds

BRAKE PAD	COMPOUND CODE
DTC-70	U
DTC-60	G
DTC-30	W
DTC-05	H
HT-14	V
HT-10	S
MT-4	L
Blue 9012	E
Black	M
DR-97	J
HP Plus	N



Pad thickness in inches (and millimeters) to include core and friction material

Carry-over column for industry reference numbers and pad thickness

Hawk Performance part number

Hawk Performance compound codes

Industry reference numbers (FMSI)

Length in inches (and millimeters)

Original equipment and/or aftermarket caliper manufacturer

Width in inches (and millimeters)

PART NUMBER

F, N, S, E | FMSI D629 | .630 [16]

4.70 [119]

3.27 [83]

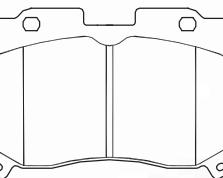

TOYOTA SUPRA TURBO

HB100

F, N, U, G | .480 [12]
W, H, S, L | .625 [16]
E, M, J

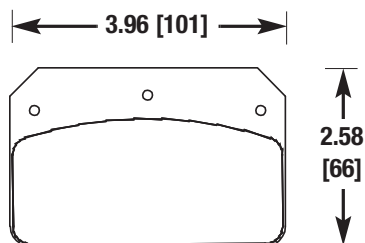

OUTLAW, SIERRA,
WILWOOD

HB103

F, Z, Y, P | FMSI D52 | .590 [15]
N, U, G, W | FMSI D122
H, S, L, E | FMSI D313
M

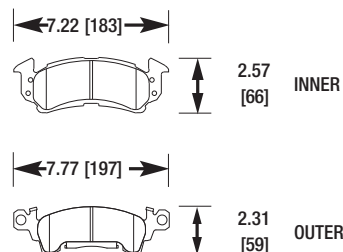

GM INTERMEDIATE

HB101

F, N, U, G, | .800 [20]
W, H, S, L,
E, M

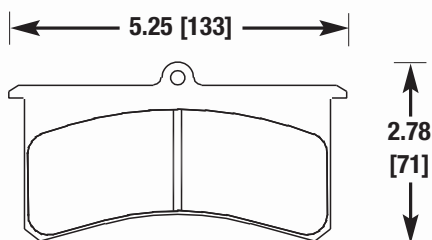

AP RACING, OUTLAW,
SIERRA, WILWOOD

HB104

F, N, W, H | .485 [12]
S, L, E, M
J

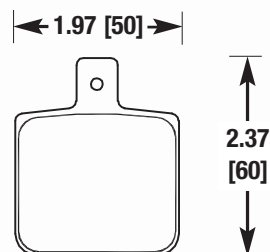

OUTLAW, SIERRA,
WILWOOD

HB102

F, N, U, G | .800 [20]
S, L, E, M

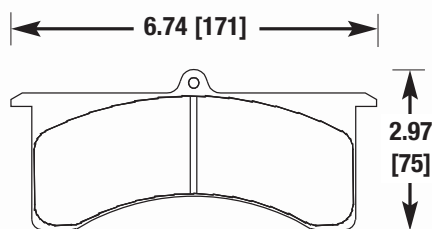

AP RACING, SIERRA,
WILWOOD

HB105

F, Z, N, U | FMSI D5 | .620 [16] | .980 [25]
G, E, S | .708 [18]
.775 [20]

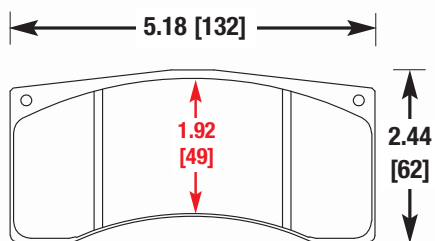

ALCON, BREMBO,
PORSCHE

HB107

U, G, V				.620 [16]
S, E				

4.47 [114]

1.86 [47]

ALCON, AP RACING, FORMULA ATLANTIC

HB110

F, Z, N, U				.654 [17]
G, S, E				.775 [20]

5.20 [132]

1.98 [50]

2.19 [56]

ALCON, AP RACING

HB108

G, V, S	FMSI D5			0.560 [14]
E, M				

2.76 [70]

2.25 [57]

AP RACING, FORMULA FORD 2000, LUCAS GIRLING

HB111

F, Z, N, U	FMSI D412			.610 [15]
G, S, E, M				

6.61 [171]

2.01 [52]

CAMARO, CORVETTE, FIREBIRD, MUSTANG

HB109

F, Z, U				.710 [18]
				.980 [25]
				1.120 [28]

5.98 [152]

2.12 [54]

3.20 [81]

ALCON, AP RACING

HB112

F, Z, N, U	FMSI D213			.540 [14]
G, S, E, M	FMSI D295			
	FMSI D413			

4.48 [114]

2.20 [56] INNER

4.48 [114]

2.18 [55] OUTER

CAMARO, CORVETTE, FIREBIRD (REAR)

HB113

F, N, G, E | FMSI D373 | .590 [15]

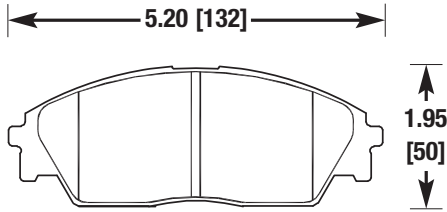

HONDA

HB117

E, M | | .380 [10]

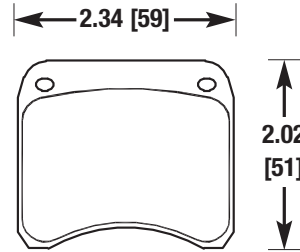

ALCON, AP RACING,
FORMULA FORD 1600

HB114

E | | .980 [25]

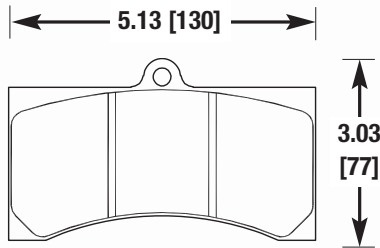

ALCON, AP RACING,
WILWOOD

HB118

E, M | FMSI D44 | .560 [14]

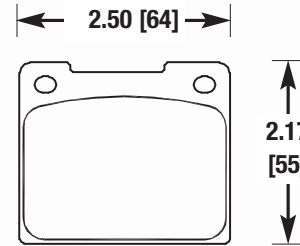

FORMULA MAZDA, LUCAS GIRLING

HB116

S, E, M | | .580 [15]

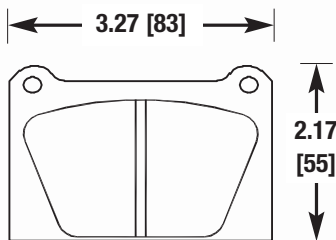

ALCON, LUCAS GIRLING

HB119

F, Z, Y, P | FMSI D138 | .594 [15]
N, U, G, W | FMSI D154 |
H, S, L, E | FMSI D202 |
M

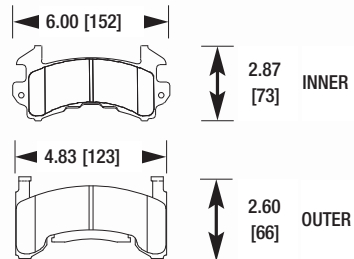

GM METRIC

HB120

F, Z, N, E | FMSI D531 | .560 [14]

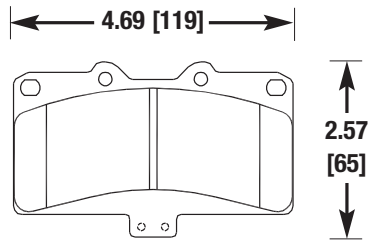

DODGE STEALTH, MITSUBISHI 3000GT

HB123

F, N, E, M | FMSI D61 | .535 [14]

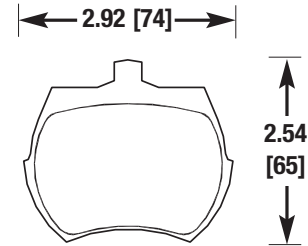

AUSTIN, MG,
MORRIS, TRIUMPH, WOLSELEY

HB121

S, E | .710 [18]
.980 [25]

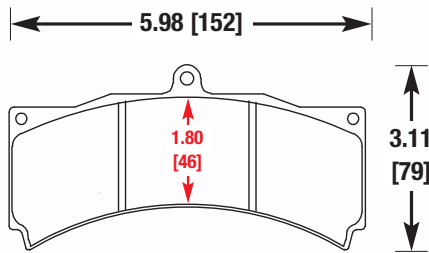

ALCON AP RACING

HB125

F, N, E | FMSI D199
FMSI D200
FMSI D499 | .650 [17]

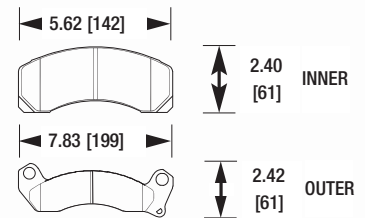

FORD, LINCOLN, MERCURY

HB122

F, Z, N | .710 [18]
U, G, E | .980 [25]

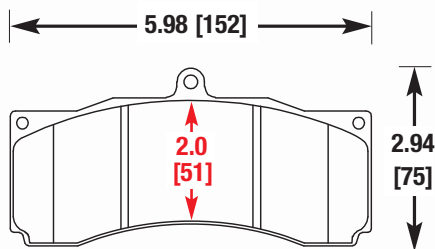

ALCON, AP RACING

HB126

F, N, S, E | FMSI D8 | .505 [13]

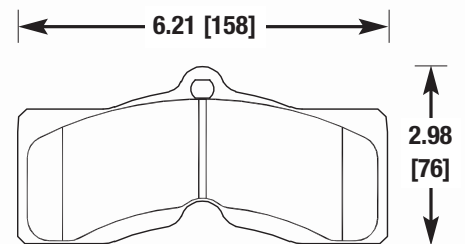

CHEVY, PONTIAC

HB128

F, N, U, S | | | .505 [13]
E

6.18 [157]

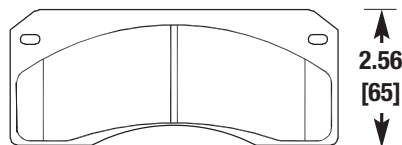

CORVETTE TWIN PIN

HB131

F, P, N, U | FMSI D153 | | .595 [15]
W, L, M | FMSI D392
FMSI D614

7.21 [183]



7.77 [197]



CHEVROLET IMPALA, CAPRICE, POLICE & HD

HB129

F, Z, N | FMSI D505 | | .681 [17]

5.82 [148]

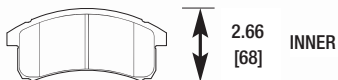

8.37 [213]



BUICK, CADILLAC, CHEVY, OLDS, PONTIAC

HB132

F, N, E, M | FMSI D27 | | .580 [15]

3.50 [89]

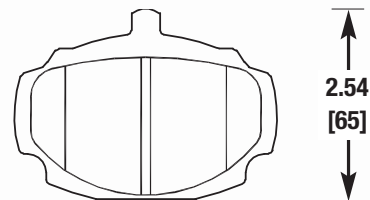

HUMBER, MG, SAAB, SINGER, VAUXHALL

HB130

U, G, W, S | | 1.018 [26] | .684 [17]
1.097 [28] | .775 [20]
|.980 [25]

5.47 [139]

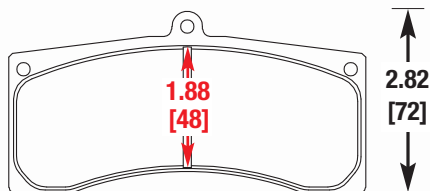

BREMBO, WILWOOD

HB134

E, J | FMSI D292 | | .665 [17]
.706 [18]

3.93 [100]

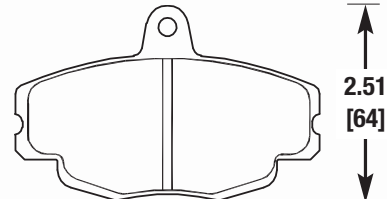

RENAULT

HB135

F, Z, N, U	FMSI D394	.642 [16]
G, V, S, E	FMSI D725	.770 [20]

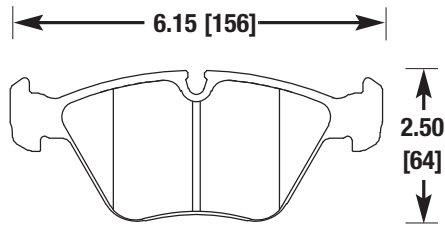

AUDI, BMW, JAGUAR

HB138

S, E	.690 [18]
------	-----------

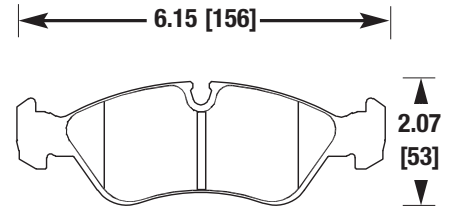

OPEL ASTRA

HB136

F, Z, N, U	FMSI D588	.690 [18]
G, S, E		

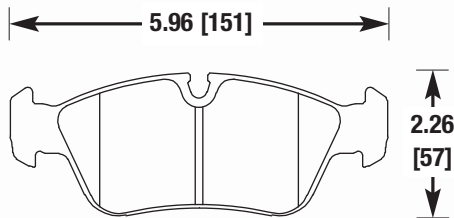

BMW

HB141

F, Z, N, U	FMSI D372	.650 [17]
G, V, S, E	FMSI D447 FMSI D609	.709

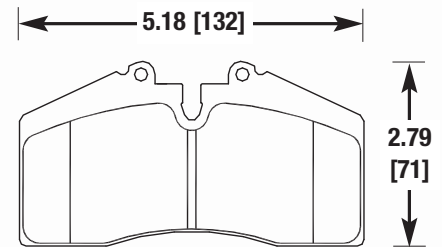

AUDI, FERRARI, PORSCHE

HB137

F, Z, N, U	FMSI D253	.690 [18]
G, S, E	FMSI D395	

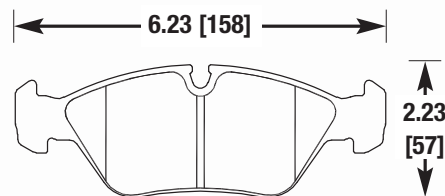

BMW, FERRARI, PORSCHE

HB143

F, Z, Y, N	FMSI D503	.680 [17]
G, W, S, E		

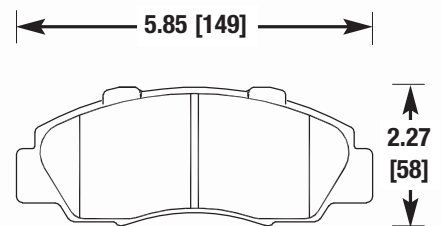

ACURA, HONDA, ISUZU

HB144

F, Z, E | FMSI D568 | .690 [18]
.719

5.42 [138]

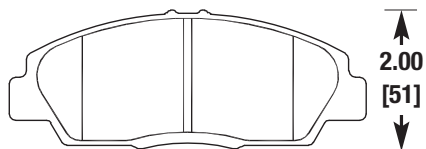

HONDA PRELUDE

HB149

F, Z, N, G | FMSI D635 | .505 [13]
W, S, E, M

4.33 [110]

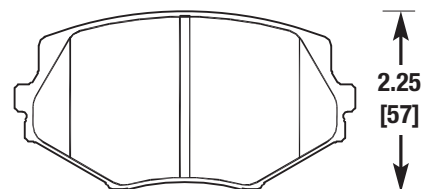

MAZDA MIATA

HB145

F, Z, Y, N | FMSI D536 | .570 [14]
U, W, S | FMSI D537 |
E, M | FMSI D1086 |

3.49 [89]

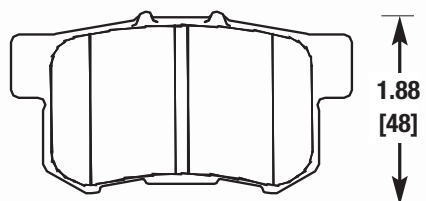

ACURA, HONDA, ISUZU (REAR)

HB150

F, N, E | FMSI D76 | .555 [14]

4.28 [109]

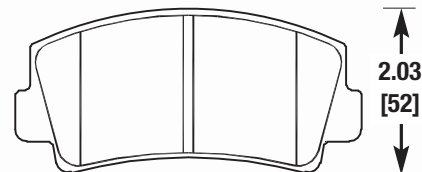

FORD, MAZDA

HB148

F, Z, N, G | FMSI D457 | .560 [14]
W, S, E, M | FMSI D468 |
| FMSI D525 |

4.34 [110]

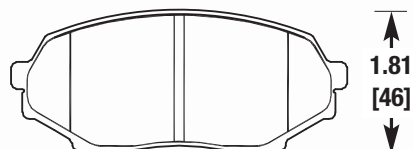

GEO, ISUZU, MAZDA, PONTIAC

HB151

F, N, E, M | FMSI D235 | .505 [13]

3.87 [98]



INNER

3.90 [99]



OUTER

MAZDA RX-7 (REAR)

HB152

F, N, S | FMSI D131 | .540 [14]
E, M

5.04 [128]

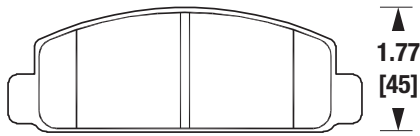

MAZDA RX-7

HB157

F, Z, N, G | FMSI D458 | .484 [12]
W, E, M

4.02 [102]

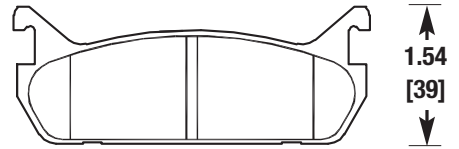

FORD, MAZDA, MERCURY (REAR)

HB155

F, N, G, S | FMSI D331 | .580 [15]
E, M | FMSI D463
FMSI D585

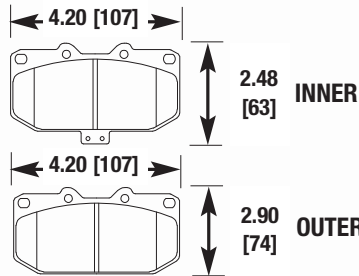

MAZDA RX-7

HB158

F, Z, N, G | FMSI D283 | .515 [13]
W, S, E, M | FMSI D332
FMSI D482

4.23 [107]

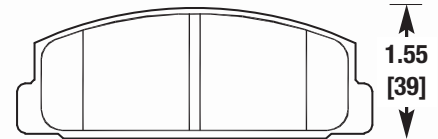

MAZDA RX-7 (REAR)

HB156

E | FMSI D94 | .562 [14]
FMSI D169
FMSI D172

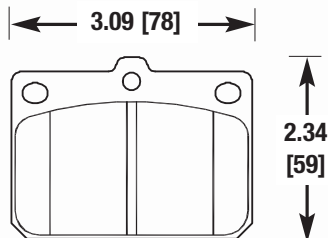

HYUNDAI, MAZDA, MITSUBISHI, TOYOTA

HB159

F, Z, N, G | FMSI D636 | .492 [12]
W, S, E, M | FMSI D663

4.02 [102]

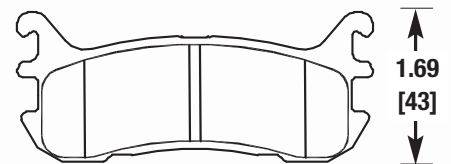

FORD, MAZDA, MERCURY (REAR)

HB167

U, G, W, E

.620 [16]
.778 [20]
.854 [22]

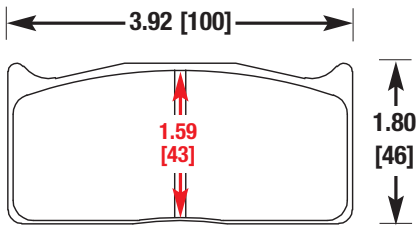

AP RACING, BREMBO, FORMULA ATLANTIC

HB170

F, Z, N, U
G, S, E, M

FMSI D345
FMSI D446
FMSI D608

.650 [17]
.710 [18]

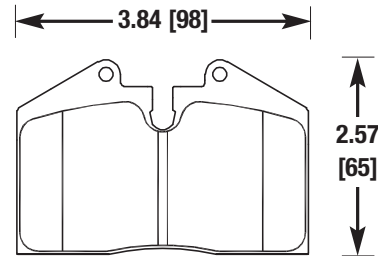

AUDI, FERRARI, PORSCHE

HB168

U

.770 [20]

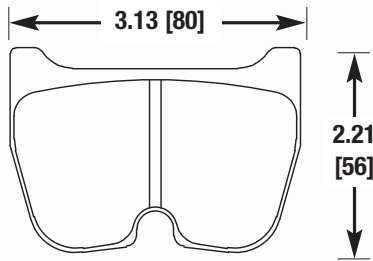

BREMBO

HB171

F, N, S, E

FMSI D45
FMSI D287

.590 [15]
.720

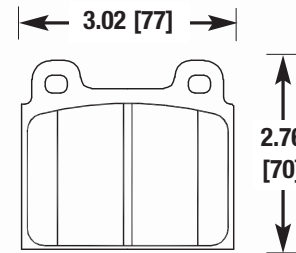

ALFA ROMEO, FERRARI, MERCEDES,
OPEL, PORSCHE

HB169

F, N, U, W
S, E, M

FMSI D57
FMSI D114
FMSI D161

.560 [14]

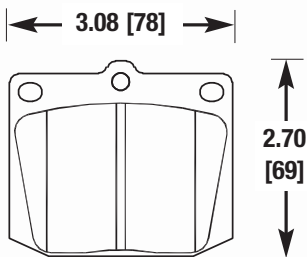

NISSAN

HB172

F, Z, N, U
G, S, E

FMSI D31
FMSI D58
FMSI D861

.500 [13]
.595 [15]

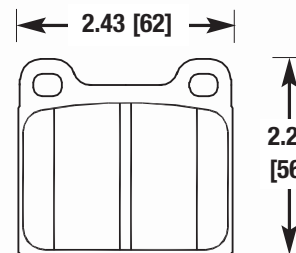

ALFA ROMEO, BMW, MERCEDES,
PORSCHE, VOLVO

HB173

F, Z, N, E	FMSI D294	.570 [14] .595 [15]
------------	-----------	------------------------

INNER
OUTER

CORVETTE

HB178

F, Z, N, G S, E	FMSI D460 FMSI D647 FMSI D1182	.564 [14]
--------------------	--------------------------------------	-----------

INNER
OUTER

NISSAN 300ZX

HB176

F, Z, N, E	FMSI D415 FMSI D512 FMSI D559 FMSI D641	FMSI D658 FMSI D759 FMSI D782	.614 [16] .680 [17]
------------	--------------------------------------------------	-------------------------------------	------------------------

CHRYSLER, DODGE, EAGLE,
PLYMOUTH (REAR)

HB179

F, Z, N S, E	FMSI D461	.630 [16]
-----------------	-----------	-----------

NISSAN 300ZX (REAR)

HB177

F, Z, N G, E	FMSI D642	.630 [16] .710 [18]
-----------------	-----------	------------------------

INNER
OUTER

CHRYSLER, DODGE, EAGLE, PLYMOUTH

HB180

F, Z, N, U G, W, S, E	FMSI D109 FMSI D174 FMSI D961	.640 [16] .560 [14] .591 [15]
--------------------------	-------------------------------------	-------------------------------------

ALFA ROMEO, BMW, LOTUS,
NISSAN, OPEL

HB181

F, Z, N, U	FMSI D639	.590 [15]
G, S, E	FMSI D960	.660 [17]

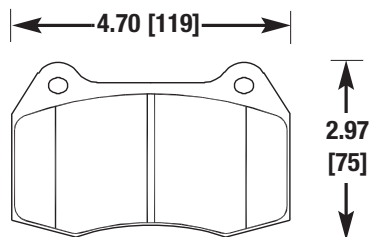

BMW, NISSAN

HB184

F, Z, N, S	FMSI D594	.650 [17]
E, U, G		.708 [18]
		.710 [18]
		.787 [20]

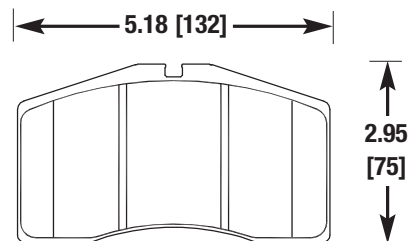

AUDI, BREMBO, PORSCHE

HB182

F, Z, N, E	FMSI D600	.660 [17]
------------	-----------	-----------

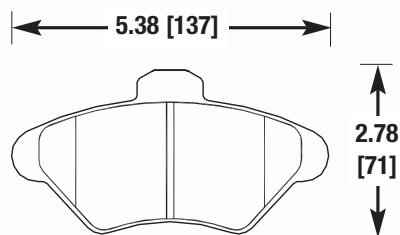

FORD, MERCURY

HB185

F, Z, N, E	FMSI D504	.590 [15]
M		

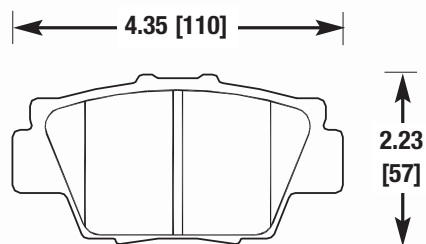

ACURA NSX

HB183

F, Z, N, U	FMSI D627	.585 [15]
G, E, M		.660 [17]

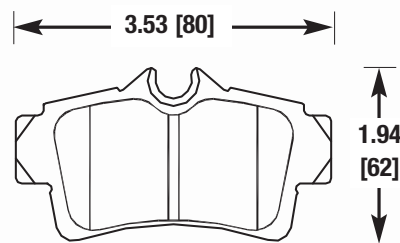

MUSTANG (REAR)

HB186

U		.770 [20]
		.854 [22]

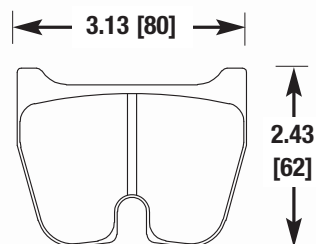

BREMBO

HB189

F, Z, N, S	FMSI D158	FMSI D307	.550 [14]
E	FMSI D206	FMSI D569	.595 [15]
	FMSI D280		

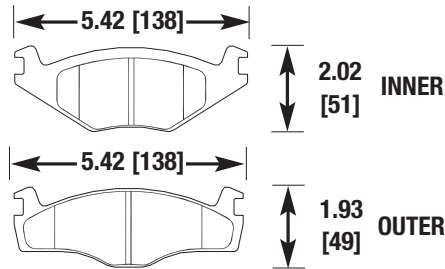

VOLKSWAGEN

HB192

U, G, S		.620 [16]
---------	--	-----------

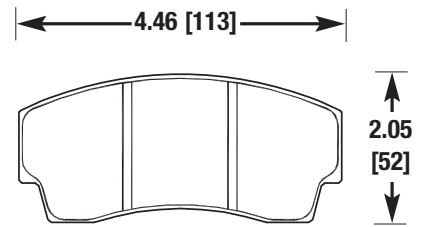

ALCON, AP RACING, FORMULA ATLANTIC

HB190

F, Z, N, U	FMSI D227	FMSI D696	.600 [15]
G, S, E	FMSI D290		.730 [19]
	FMSI D684		

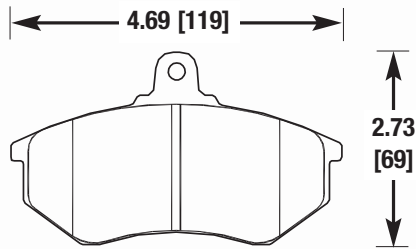

AUDI, VOLKSWAGEN

HB193

F, Z, N, U	FMSI D810	.670 [17]
G, V, S, E	FMSI D968	

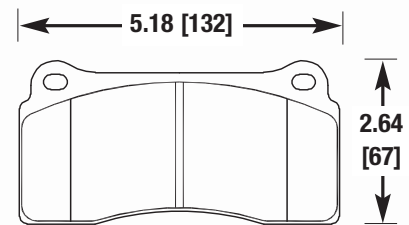

ASTON MARTIN, BREMBO F-40, DODGE, FERRARI, LAMBORGHINI, JAGUAR

HB191

F, Z, N, S	FMSI D241	FMSI D356	.590 [15]
E	FMSI D242	FMSI D539	
	FMSI D302	FMSI D570	

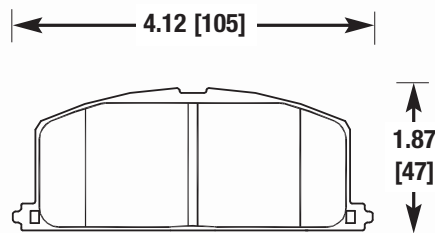

CHEVY, GEO, LEXUS TOYOTA

HB194

F, Z, Y, N	FMSI D592	.570 [14]
U, V, S, E	FMSI D1053	.665 [17]

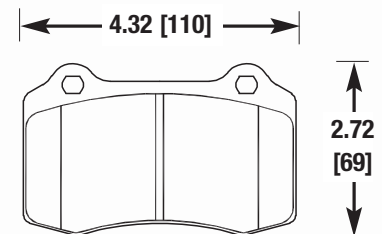

ESPIRIT, JAGUAR, MUSTANG, VIPER

HB195

F, Z, N, G	FMSI D278	FMSI D487	.640 [16]
S, E	FMSI D439	FMSI D493	
	FMSI D454	FMSI D621	

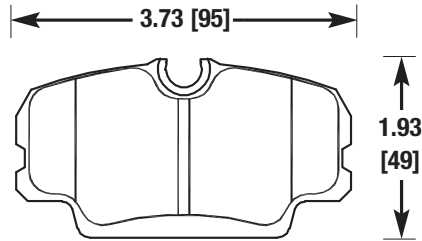

ALFA ROMEO, BMW, MERCEDES,
PEUGEOT, SAAB

HB201

F, N	FMSI D631	.620 [16]
------	-----------	-----------

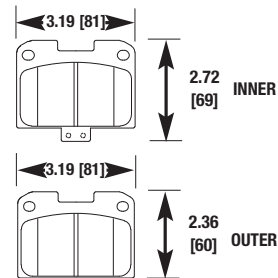

DODGE STEALTH, MITSUBISHI 3000GT (REAR)

HB198

F, N, G, S	FMSI D252	.565 [14]
E	FMSI D254	.685 [17]
	FMSI D445	

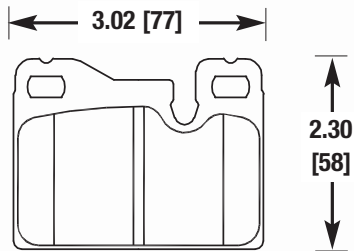

PORSCHE

HB202

F, N, E	FMSI D189	.580 [15]
	FMSI D282	

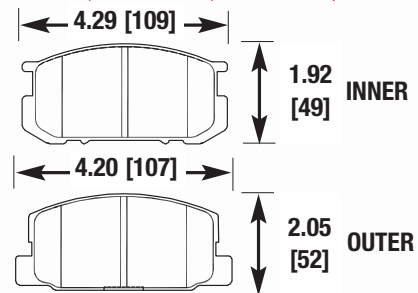

SUBARU, TOYOTA

HB199

F, N, U, S	FMSI D141	FMSI D443	.660 [17]
E	FMSI D251	FMSI D455	.702 [18]
	FMSI D424		

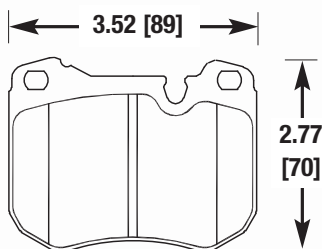

LAMBORGHINI, MERCEDES,
PEUGEOT, PORSCHE

HB203

F, N, M	FMSI D305	.550 [14]
---------	-----------	-----------

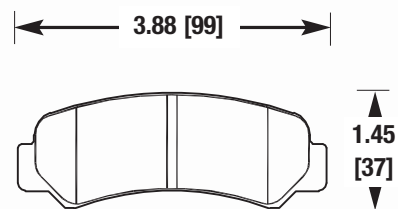

TOYOTA COROLLA (REAR)

HB204

F, Z, N, S | FMSI D43 | .615 [16]
E

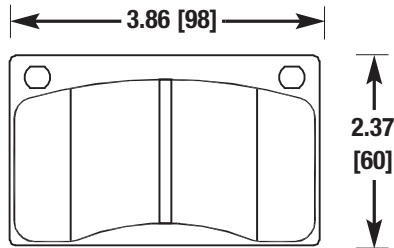

VOLVO

HB207

F | FMSI D100 | .580 [15]
FMSI D145

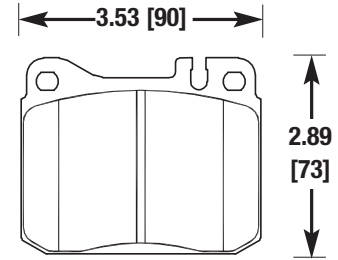

LAMBORGINI, MERCEDES

HB205

F | FMSI D659 | .672 [17]
FMSI D678

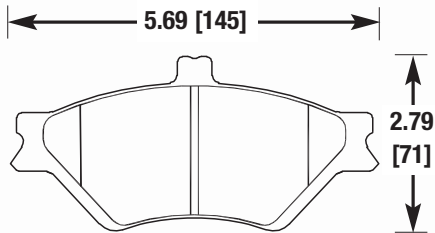

FORD, LINCOLN, MERCURY

HB208

U | .620 [16]
.708 [18]
.787 [20]
.866 [22]

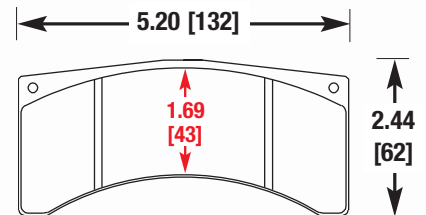

BREMBO F3000, WILWOOD

HB206

F, N, E | FMSI D163 | .565 [14]
.700 [18]

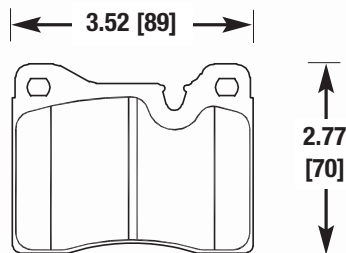

BMW, FERRARI, LAMBORGHINI, MASERATI

HB210

F, Z, Y, P | FMSI D477 | .677 [17]
FMSI D712

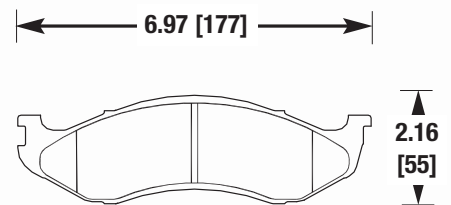

JEEP

HB211

F, Z, N | FMSI D583 | .606 [15]
 FMSI D637
 FMSI D893

5.18 [132]

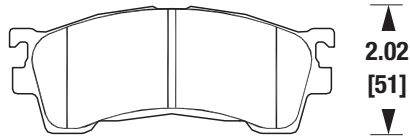

FORD, MAZDA

HB214

F, Z, Y, N | FMSI D530 | .618 [16]
 S, E | FMSI D723

5.90 [150]

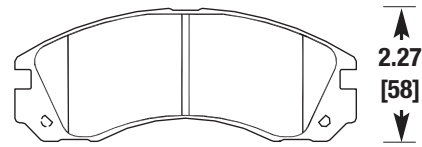

DODGE, EAGLE,
 MITSUBISHI, PLYMOUTH

HB212

F, Z | FMSI D584 | .535 [14]

3.94 [100]

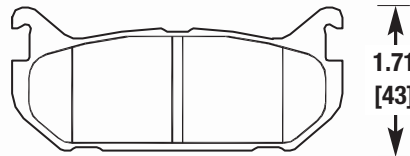

FORD, MAZDA (REAR)

HB215

F, N, S, E | FMSI D629 | .630 [16]

4.70 [119]

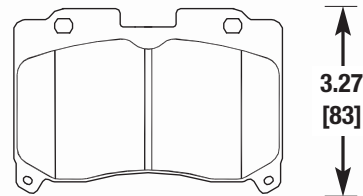

TOYOTA SUPRA TURBO

HB213

F, Z, N, E | FMSI D484 | .626 [16]

5.03 [128]

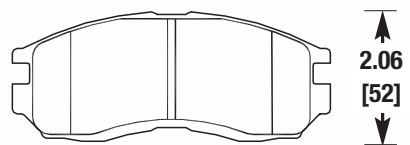

CHRYSLER, DODGE, EAGLE,
 MITSUBISHI, PLYMOUTH

HB216

F, N, E | FMSI D630 | .590 [15]

3.18 [81]

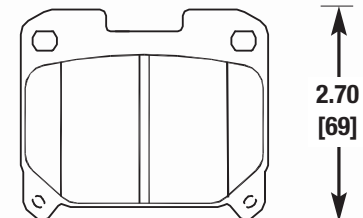

TOYOTA SUPRA TURBO (REAR)

HB217

F, Z, N, E	FMSI D623	.681 [17]
------------	-----------	-----------

BUICK, CADILLAC, CHEVY, OLDS, PONTIAC

HB224

U		1.120 [28]
---	--	------------

ALCON, WILWOOD

HB218

F, Z, N, G	FMSI D273	.583 [15]
S, E	FMSI D474	
	FMSI D560	

HONDA

HB227

F, Z, N, U	FMSI D396	.630 [16]
G, S, E	FMSI D692	
	FMSI D763	

BMW, SAAB (REAR)

HB221

U, G		.684 [17]
		1.100 [28]
		1.180 [30]

AP RACING, BREMBO, WILWOOD

HB229

S, E	FMSI D81	.580 [15]
------	----------	-----------

TRIUMPH

HB230

Z | FMSI D535 | .575 [15]
FMSI D602

4.49 [114]

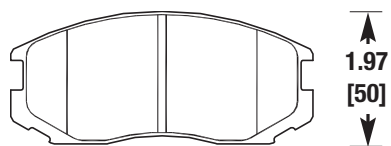

DODGE, EAGLE, MITSUBISHI, PLYMOUTH

HB233

F, Z | FMSI D650 | .635 [16]

6.96 [177]

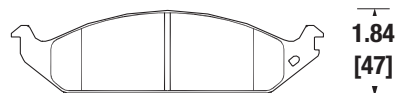

CHRYSLER, DODGE, PLYMOUTH

HB231

F, Z, N, E | FMSI D422 | .575 [15]
.625 [16]

4.77 [121]

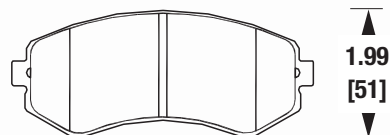

NISSAN 240SX

HB235

F, Z, N, E | FMSI D462 | .665 [17]
FMSI D463
FMSI D485

5.40 [137]

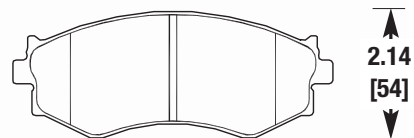

INFINITI, NISSAN

HB232

F, Z | FMSI D376 | .681 [17]

5.52 [140]

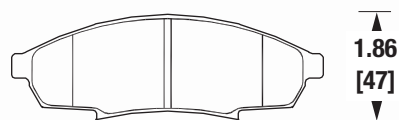

BUICK, CHEVY, OLDS, PONTIAC

HB236

F, Z, E | FMSI D668 | .622 [16]

4.27 [108]

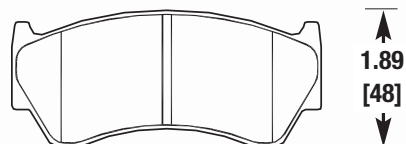

NISSAN

HB237

F, N, U, G			.480 [12]
W, H, S, L			.625 [16]
E, M			

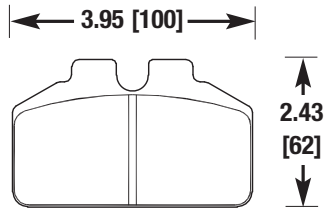

OUTLAW, SIERRA, WILWOOD

HB241

F, Z		FMSI D591			.710 [18]
------	--	-----------	--	--	-----------

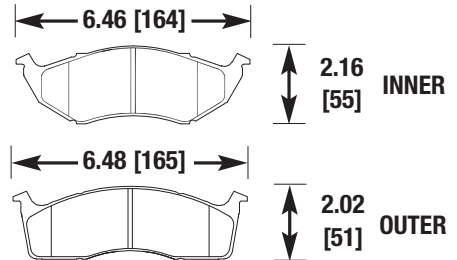

CHRYSLER, DODGE, EAGLE

HB238

U			1.180 [30]
---	--	--	------------

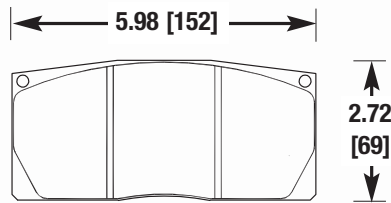

ALCON, WILWOOD

HB242

F, Z, N, G		FMSI D341			.661 [17]
E		FMSI D409			

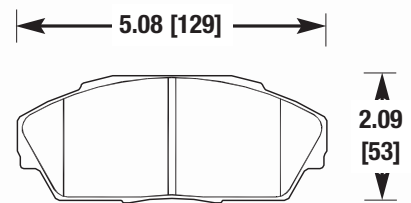

ACURA, HONDA

HB240

F, Z		FMSI D417			.620 [16]
		FMSI D421			
		FMSI D597			

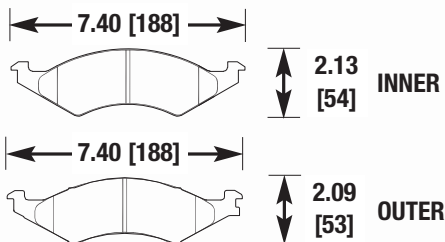

FORD, LINCOLN, MERCURY

HB244

S, E		FMSI D4			.624 [16]
------	--	---------	--	--	-----------

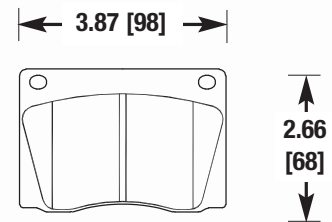

ALFA ROMEO, ASTON MARTIN,
JAGUAR, LOTUS, VOLVO

HB245

F, Z, N, S | FMSI D617 | .631 [16]
E

← 5.08 [129] →

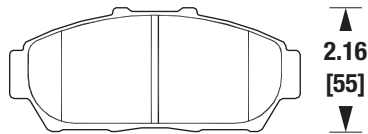

ACURA, HONDA

HB248

F, Z, N, U | FMSI D732 | .650 [17]
G, S, E

← 4.78 [121] →

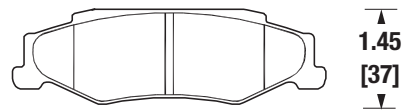

C-5 CORVETTE, CADILLAC XLR (REAR)

HB246

F, N, E | FMSI D473 | .567 [14]

← 3.61 [92] →

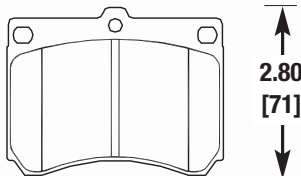

FORD, MAZDA, MERCURY

HB249

F, Z, N, U | FMSI D749 | .575 [15]
V, S

← 7.19 [183] →

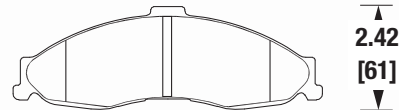

CAMARO, FIREBIRD

HB247

F, Z, N, U | FMSI D731 | .575 [15]
G, V, S, E

← 7.23 [184] →

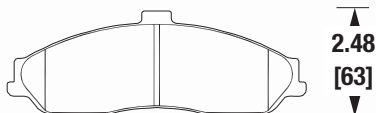

C-5 CORVETTE

HB250

F, Z, N, U | FMSI D750 | .653 [17]
G, S, E

← 4.78 [121] →

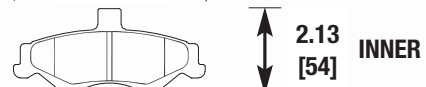

2.13 [54] INNER

← 4.78 [121] →



1.74 [44] OUTER

CAMARO, FIREBIRD (REAR)

HB251

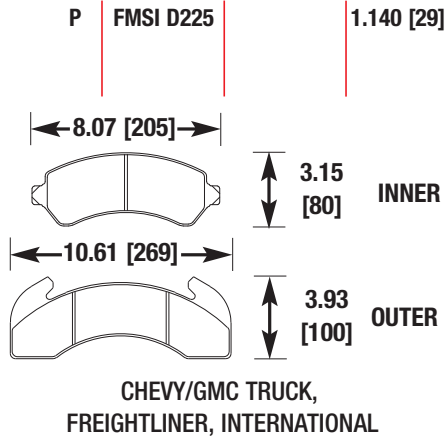

HB254

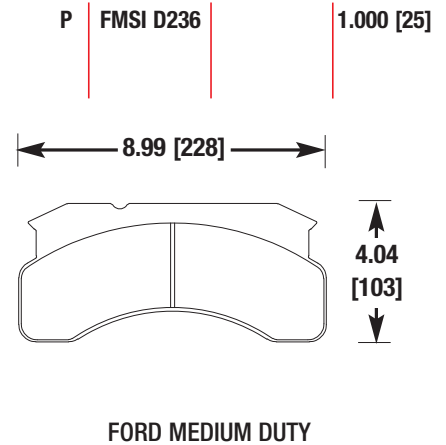

HB252

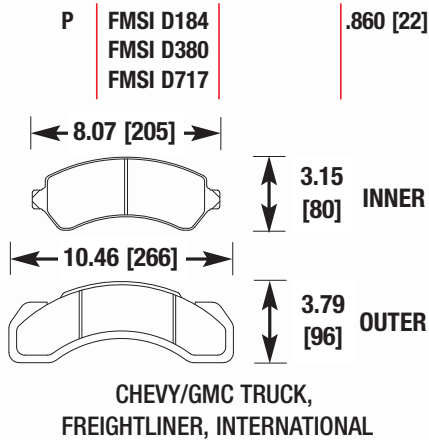

HB255

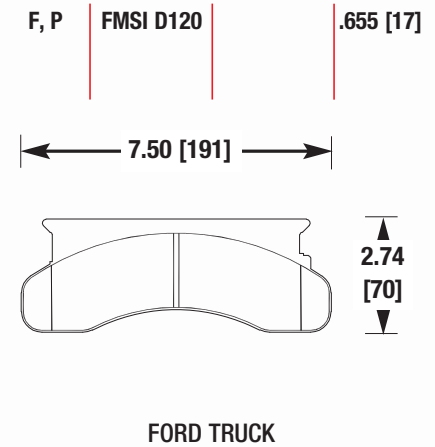

HB253

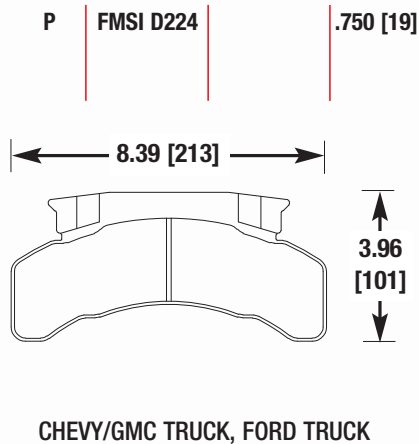

HB260

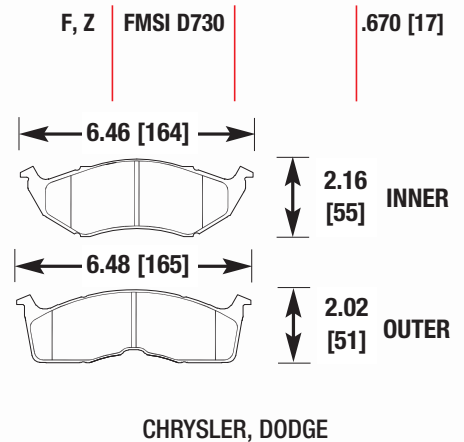

HB261

F, Z, N | FMSI D449 | .665 [17]
 FMSI D700
 FMSI D747

5.40 [137]

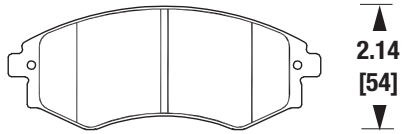

HYUNDAI, KIA

HB264

P | FMSI D1025 | .575 [15]

6.96 [177]



HUMMER H1

HB262

F, Z, N | FMSI D272 | FMSI D230 | .540 [14]
 S, E, M | FMSI D323 | FMSI D231
 FMSI D429 | FMSI D232
 FMSI D464

3.36 [85]

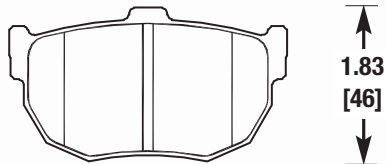

HYUNDAI, NISSAN (REAR)

HB266

F, Z, Y, P | FMSI D679 | .650 [17]

6.54 [166]

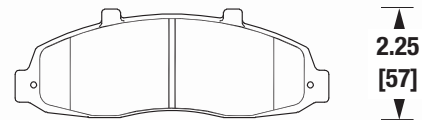

FORD F-150, LINCOLN BLACKWOOD

HB263

F, Z, N | FMSI D431 | .650 [17]
 U, E

5.62 [140]



7.83 [199]



FORD

HB268

F, Z, N | FMSI D430 | .665 [17]
 FMSI D815

5.40 [137]

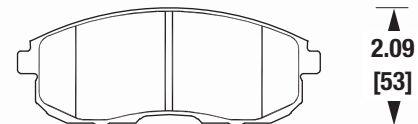

INFINITI, NISSAN

HB269

F, Z, N, V | FMSI D555 | .763 [19]
S, E

6.15 [156]

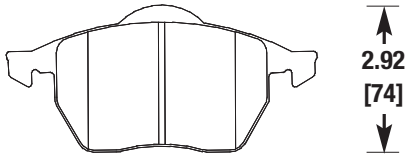

AUDI, VOLKSWAGEN

HB272

F, Z, N, E | FMSI D687 | .763 [19]

6.15 [156]

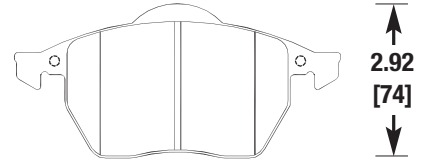

AUDI, VOLKSWAGEN

HB270

F, Z, N | FMSI D362 | .724 [18]
FMSI D419

5.70 [145]

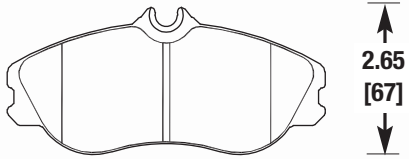

AUDI

HB274

F, Z, N, S | FMSI D804 | .610 [15]
E

6.88 [175]

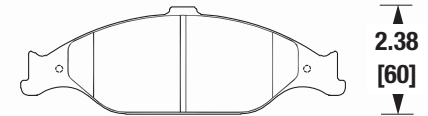

FORD MUSTANG

HB271

F, Z, N, E | FMSI D228 | .605 [15]
FMSI D306 | .635 [16]
FMSI D851

3.42 [87]

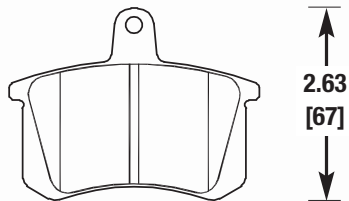

ALFA ROMEO, AUDI, VOLKSWAGEN (REAR)

HB275

F, Z, N, G | FMSI D465 | .620 [16]
S, E | FMSI D764 | .660 [17]
.720 [18]

5.43 [138]

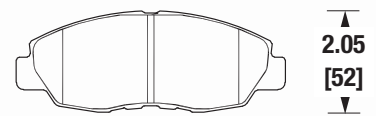

ACURA, HONDA

HB278

F, N, S, E | FMSI D491 | .465 [12]
.583 [15]

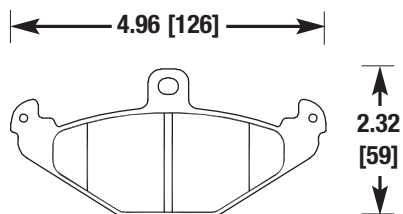

LOTUS ELISE, DODGE VIPER (REAR)

HB284

F | FMSI D664 | .575 [15]

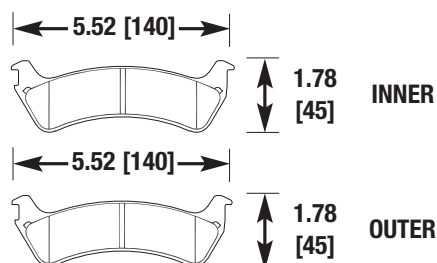

FORD WINDSTAR (REAR)

HB279

Z, Y | FMSI D205 | FMSI D607 | .594 [15]
FMSI D249 | FMSI D654
FMSI D387

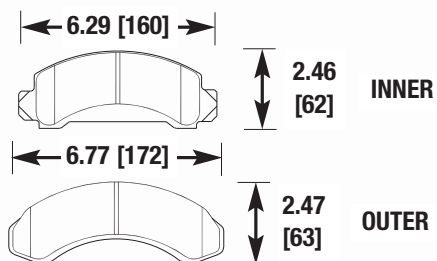

FORD RANGER

HB285

F, Y | FMSI D625 | .595 [18]

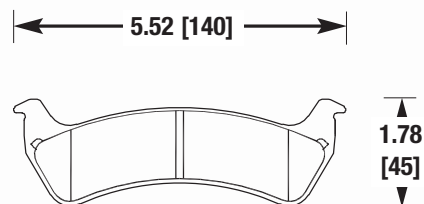

JEEP GRAND CHEROKEE

HB283

F, Z, Y, P | FMSI D652 | .650 [17]

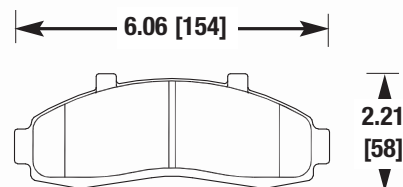

FORD TRUCK, MAZDA, MERCURY

HB286

F, Z, Y | FMSI D666 | FMSI D713 | .591 [15]

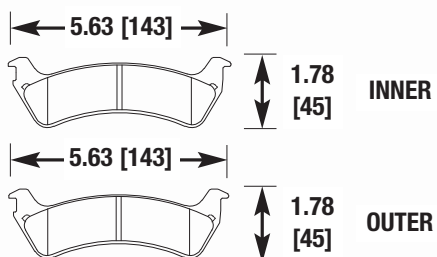

JEEP GRAND CHEROKEE (REAR)

HB287

F, Z, P	FMSI D667	.571 [15]
---------	-----------	-----------

INNER: 1.78 [45]
OUTER: 1.78 [45]

FORD EXPLORER, MERCURY MOUNTAINEER

HB291

F, Z, N, U G, S, E	FMSI D776	.642 [16]
-----------------------	-----------	-----------

3.40 [86]

PORSCHE

HB289

F, Z, N, S E	FMSI D737	.610 [15]
-----------------	-----------	-----------

4.49 [114]
3.07 [78]

PORSCHE BOXSTER

HB292

F, P	FMSI D50 FMSI D92	.674 [17]
------	----------------------	-----------

INNER: 6.21 [158], 2.35 [60]
OUTER: 7.20 [183], 2.40 [61]

FORD, LINCOLN, MERCURY

HB290

F, Z, N, U G, S, E	FMSI D738	.583 [15] .606 [15]
-----------------------	-----------	------------------------

4.41 [112]
2.88 [73]

PORSCHE (REAR)

HB293

F, Y, P	FMSI D360 FMSI D375	.634 [16] .668 [17]
---------	------------------------	------------------------

INNER: 6.21 [158], 2.35 [60]
OUTER: 7.20 [183], 2.40 [61]

FORD TRUCK

HB294

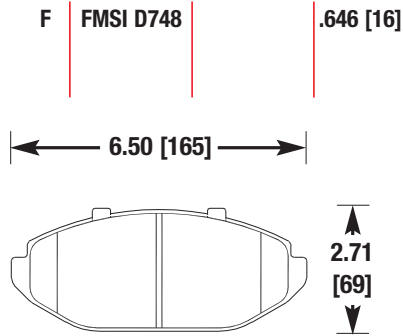

FORD, LINCOLN, MERCURY

HB298

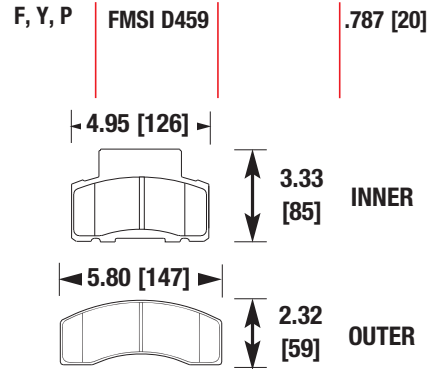

CHEVY/GMC TRUCK, DODGE TRUCK

HB295

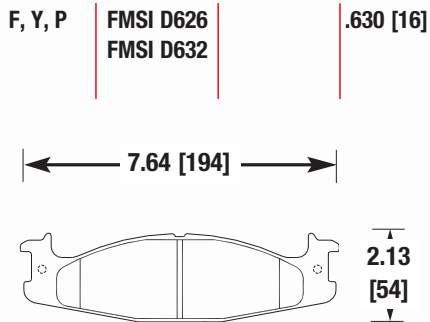

FORD TRUCK

HB299

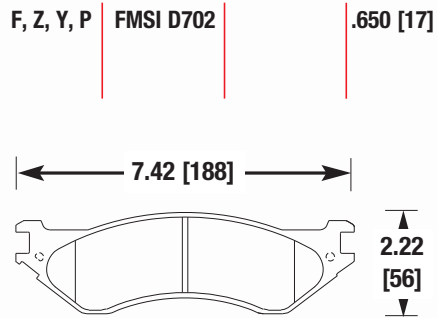

DODGE TRUCK, FORD TRUCK, LINCOLN

HB296

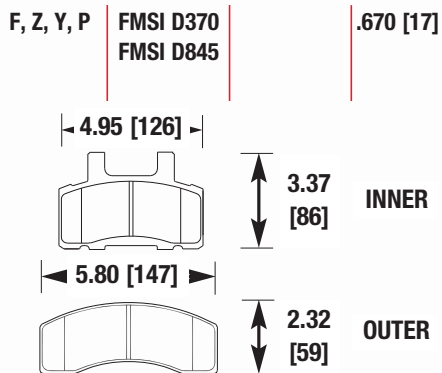

CHEVY/GMC TRUCK, DODGE TRUCK

HB300

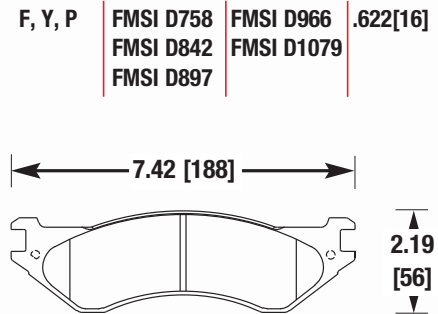

DODGE RAM 1500

HB301

F, Z, Y, P	FMSI D711 FMSI D879	.630 [16]
------------	------------------------	-----------

5.61 [142] →

1.93 [49] INNER

5.61 [142] →

1.93 [49] OUTER

FORD TRUCK, LINCOLN (REAR)

HB304

F, Z, Y, P	FMSI D726	.598 [15]
------------	-----------	-----------

6.57 [167] →

2.40 [61]

CHEVY/GMC TRUCK, ISUZU, OLDS

HB302

F, Z, Y, P	FMSI D756 FMSI D824	.700 [18]
------------	------------------------	-----------

7.61 [193] →

2.52 [64]

FORD TRUCK

HB305

F, Z, Y	FMSI D729	.610 [15]
---------	-----------	-----------

5.28 [134] →

1.84 [47]

CHEVY/GMC TRUCK, ISUZU, OLDS (REAR)

HB303

F, Z, Y, P	FMSI D757	.685 [17]
------------	-----------	-----------

6.25 [159] →

2.06 [52]

FORD TRUCK (REAR)

HB306

F, Z, Y	FMSI D746	.795 [20]
---------	-----------	-----------

7.55 [192] →

2.88 [73] INNER

7.55 [192] →

2.37 [60] OUTER

DODGE DAKOTA/DURANGO

HB307

F, Z, Y, P | FMSI D820 | .795 [20]

7.55 [192]

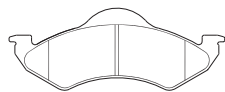

2.88 [73] INNER

7.55 [192]

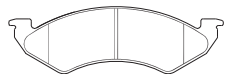

2.37 [60] OUTER

DODGE DAKOTA/DURANGO

HB311

F, Y | FMSI D611 | .591 [15]

4.70 [119]

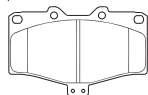

3.03 [77] INNER

4.69 [119]

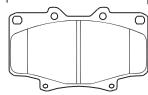

2.83 [72] OUTER

TOYOTA

HB308

F, Y | FMSI D529 | .689 [18]
FMSI D593

6.98 [177]

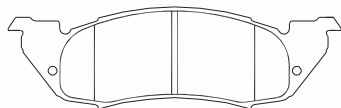

2.14 [54]

DODGE DAKOTA

HB312

F, Y, P | FMSI D502 | .591 [15]

4.69 [119]

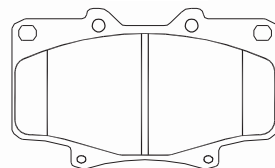

2.83 [72]

LEXUS LX450, TOYOTA LANDCRUISER

HB310

F, Z, Y, N | FMSI D562 | .689 [18]
FMSI D695

5.24 [133]

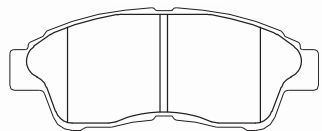

2.09 [53]

GEO, TOYOTA

HB313

F, Y, P | FMSI D772 | .685 [17]

4.69 [119]

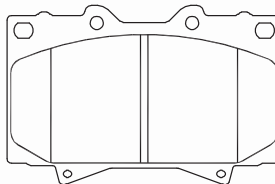

2.89 [73]

LEXUS LX470, TOYOTA LANDCRUISER

HB314

F, Z, Y, P | FMSI D812 | .665 [17]

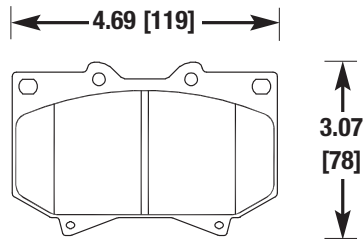

TOYOTA SEQUOIA/TUNDRA

HB317

F, Y | FMSI D410 | .591 [15]

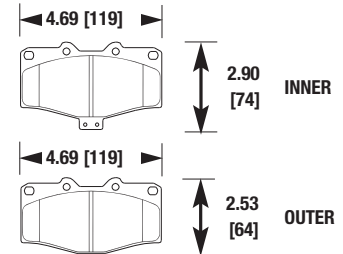

TOYOTA

HB315

F, Z, Y, P | FMSI D436 | .669 [17]

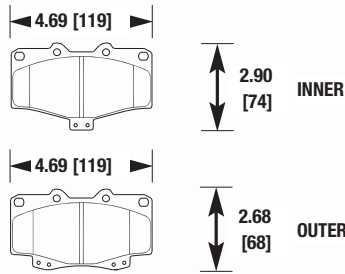

TOYOTA

HB318

F, Z, Y | FMSI D697 | .669 [17]
FMSI D718
FMSI D744

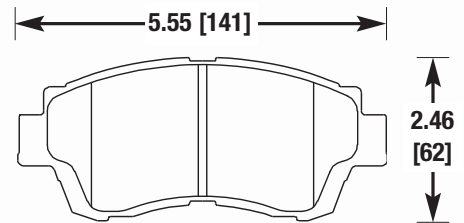

LEXUS, TOYOTA

HB316

F, Z, Y, P | FMSI D799 | .670 [17]

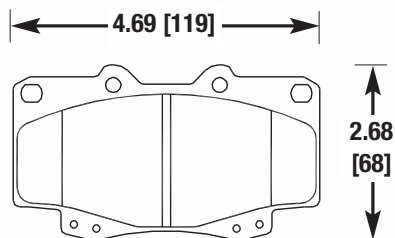

TOYOTA TACOMA

HB320

F, Z, Y | FMSI D707 | .669 [17]

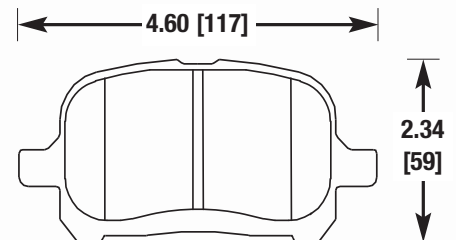

LEXUS, TOYOTA

HB321

F, Z | FMSI D741 | .650 [17]

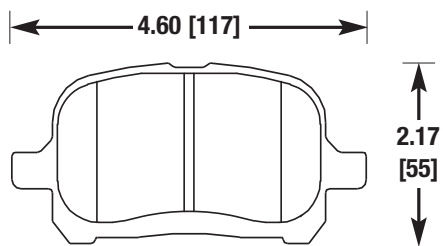

CHEVY, TOYOTA

HB324

F, Z, Y, P | FMSI D792 | .673 [17]

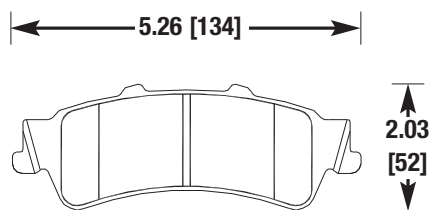

CADILLAC,
CHEVY/GMC TRUCK (REAR)

HB322

F, Z, Y, P | FMSI D784 | .717 [18]

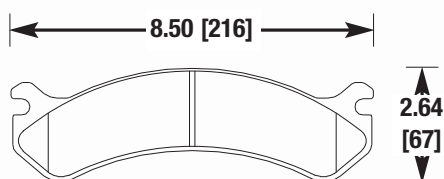

CADILLAC, CHEVY/GMC TRUCK,
HUMMER H2

HB325

F, Z, Y | FMSI D547 | .720 [18]
N, S | FMSI D681

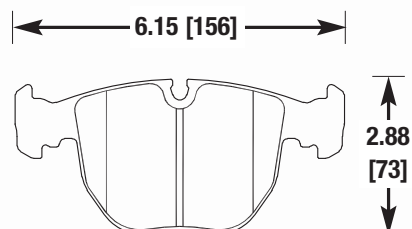

BMW

HB323

F, Z, Y, P | FMSI D785 | .724 [18]

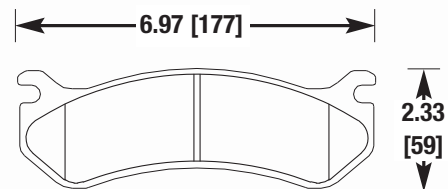

CADILLAC, CHEVY/GMC TRUCK,
HUMMER H2

HB326

F, Z, Y | FMSI D691 | .646 [16]
FMSI D855

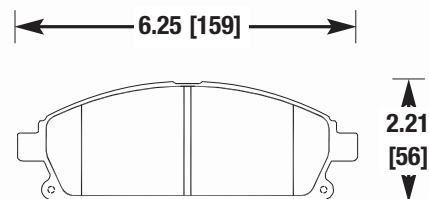

INFINITI, NISSAN

HB327

P | FMSI D786 | .799 [20]
1.050 [27]

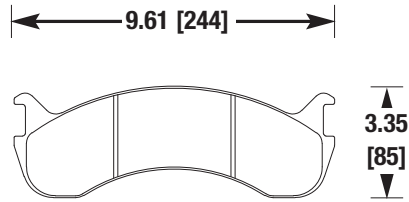

INTERNATIONAL

HB331

U, G | .854 [22]
1.170 [30]

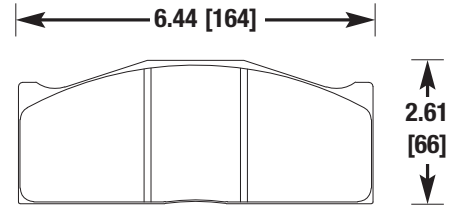

AP RACING, BREMBO
TRANS AM

HB328

F, Z, N, S | FMSI D817 | .685 [17]

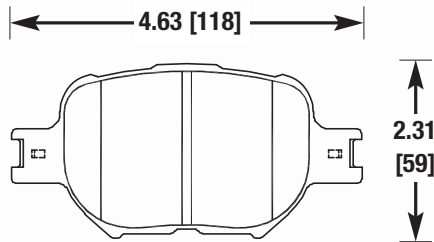

TOYOTA CELICA

HB332

F, Z, Y, P | FMSI D369
FMSI D789 | .654 [17]

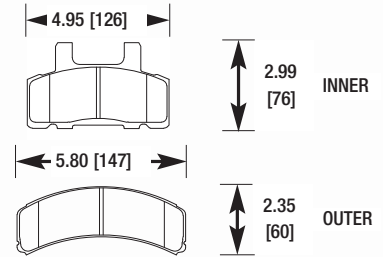

CADILLAC, CHEVY/GMC TRUCK,
DODGE TRUCK

HB329

F, Z | FMSI D823 | .543 [14]

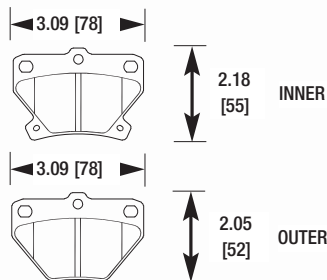

TOYOTA CELICA (REAR)

HB333

F, P | FMSI D557 | .776 [20]

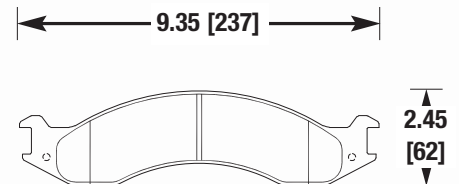

FORD TRUCK

HB334

F, Y, P | FMSI D655 | .705 [18]
.736 [19]

8.66 [220]

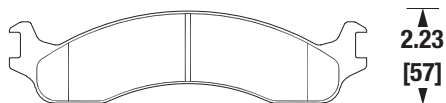

DODGE TRUCK, FORD TRUCK

HB337

P | FMSI D149 | .791 [20]
FMSI D543

7.20 [183]



2.59 [66] INNER

8.12 [206]



2.78 [71] OUTER

CHEVY/GMC TRUCK

HB335

F, P | FMSI D777 | .815 [21]

8.72 [221]

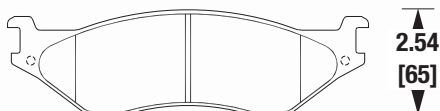

FORD TRUCK

HB340

F, S | .710 [18]

5.51 [140]

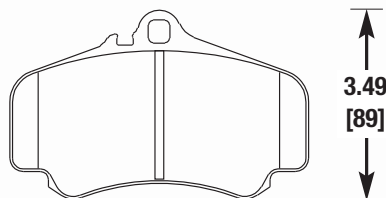

3.49 [89]

PORSCHE 996 GTR

HB336

F, Y, P | FMSI D450 | .655 [17]

7.50 [191]

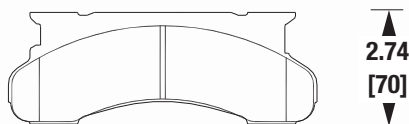

FORD TRUCK

HB341

F | FMSI D674 | .618 [16]

5.53 [140]



1.94 [49] INNER

5.53 [140]



1.94 [49] OUTER

FORD, LINCOLN,
MERCURY (REAR)

HB342

F, Z, Y | FMSI D803 | .701 [18]

6.46 [164]

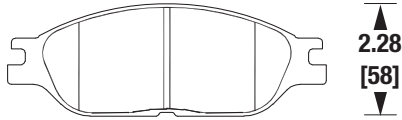

FORD WINDSTAR

HB346

F, Z, N, E | FMSI D816 | .713 [18]

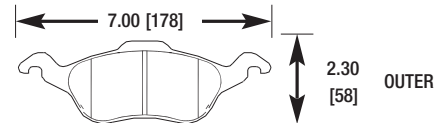
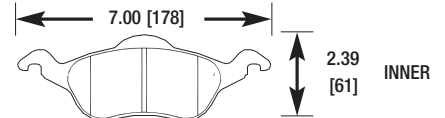

FORD FOCUS

HB344

P | FMSI D769 | .992 [25]

9.43 [240]

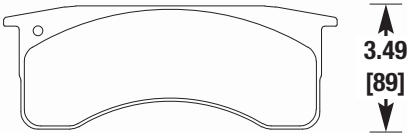

CHEVY/GMC TRUCK,
FORD TRUCK, THOMAS

HB347

F, Z | FMSI D601
FMSI D656 | .689 [18]

4.87 [124]

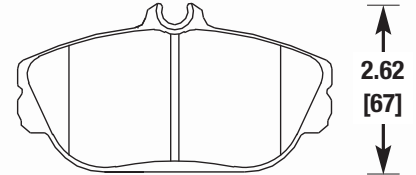

FORD, LINCOLN, MERCURY

HB345

P | FMSI D411 | .815 [21]

8.66 [220]

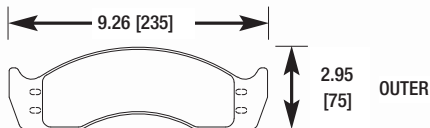
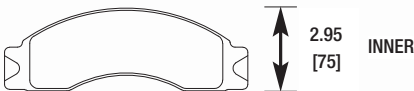

FORD TRUCK

HB348

U, G, V | .980 [25]
1.140 [29]

6.44 [164]

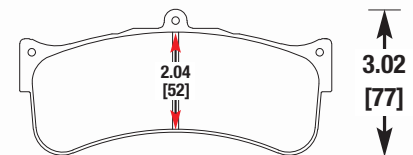

BREMBO

HB349

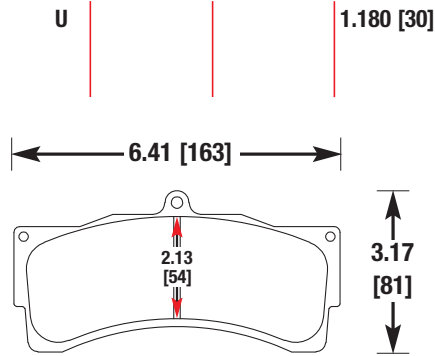

ALCON, AP RACING

HB352

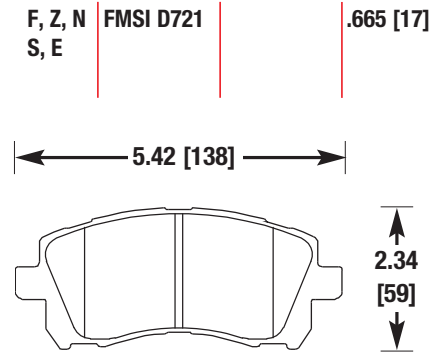

SUBARU

HB350

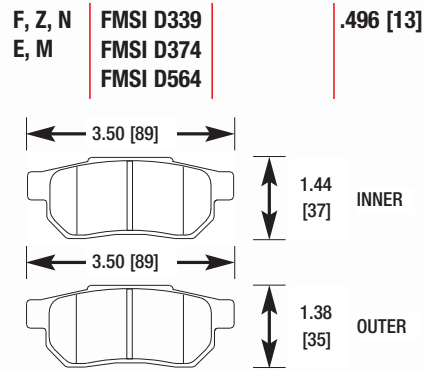

ACURA, HONDA (REAR)

HB353

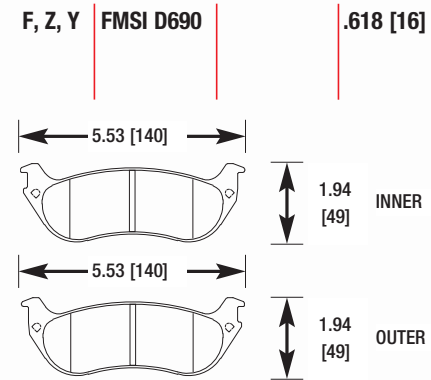

FORD, LINCOLN, MERCURY (REAR)

HB351

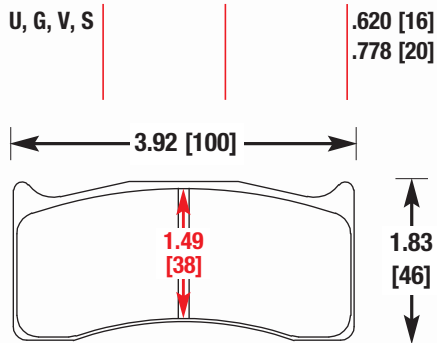

BREMBO, TOYOTA ATLANTIC,
WILWOOD

HB354

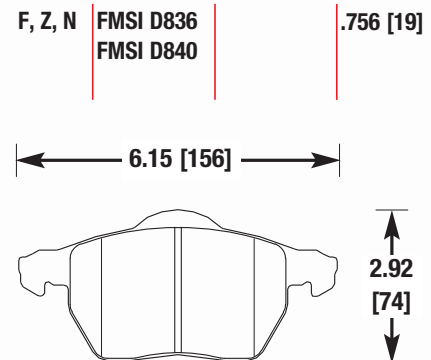

AUDI, VOLKSWAGEN

HB356

F, Y	FMSI D368	.654 [17]
------	-----------	-----------

CHEVY/GMC TRUCK

HB361

F, Z, N, U G, S, E	FMSI D829	.622 [16]
-----------------------	-----------	-----------

ACURA RSX, HONDA S2000

HB359

F, Z, N	FMSI D508 FMSI D698 FMSI D714	FMSI D754 FMSI D814	.543 [14]
---------	-------------------------------------	------------------------	-----------

BUICK, CADILLAC, CHEVY,
OLDS, PONTIAC (REAR)

HB362

F, Z, Y N, S, E	FMSI D548	.642 [16]
--------------------	-----------	-----------

BMW (REAR)

HB360

F, Z, N	FMSI D699 FMSI D818 FMSI D850	FMSI D1075 FMSI D1224	.670 [17]
---------	-------------------------------------	--------------------------	-----------

BUICK, CADILLAC, CHEVY,
OLDS, PONTIAC

HB363

F, N, E	FMSI D839 FMSI D912	.689 [18]
---------	------------------------	-----------

AUDI, VOLKSWAGEN

HB364

F, Z, N, E	FMSI D1017 FMSI D1023 FMSI D1112	FMSI D340 FMSI D894	.587 [15] .642 [16]
------------	----------------------------------------	------------------------	------------------------

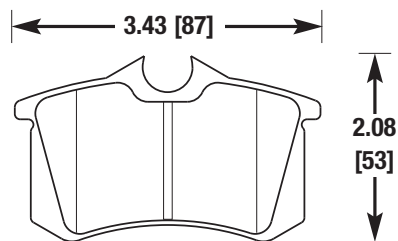

AUDI, PEUGEOT,
VOLKSWAGEN (REAR)

HB367

F, Z, N	FMSI D383 FMSI D471	.585 [15]
---------	------------------------	-----------

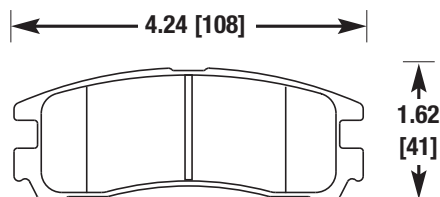

CHRYSLER, DODGE, EAGLE,
MITSUBISHI, SUBARU (REAR)

HB365

F, Z, N	FMSI D768	.728 [18]
---------	-----------	-----------

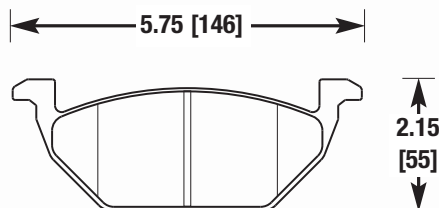

VOLKSWAGEN

HB368

F, Z	FMSI D924	.665 [17]
------	-----------	-----------

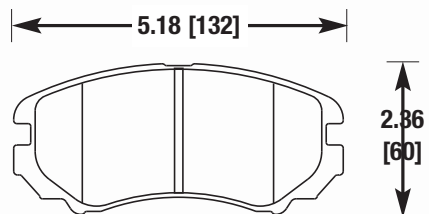

HYUNDAI, KIA

HB366

F, Z, N U, G, E	FMSI D787	.681 [17]
--------------------	-----------	-----------

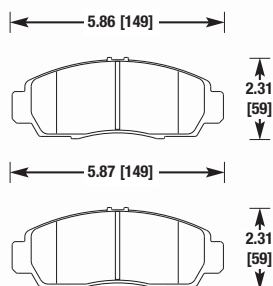

ACURA, HONDA

HB369

U, S	.775 [20] .980 [25]
------	------------------------

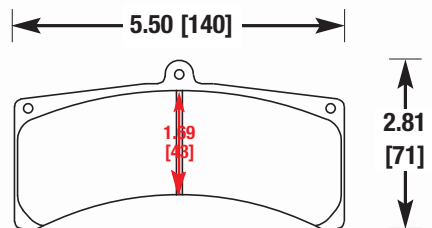

WILWOOD

HB370

F, Z, N, E | FMSI D905 | .559 [14]

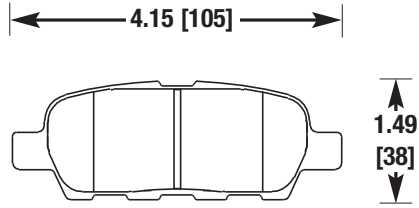

NISSAN (REAR)

HB373

F, Y | FMSI D844
FMSI D856 | .689 [18]

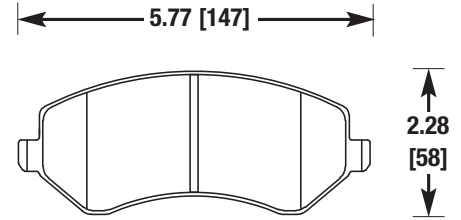

BUICK, CHRYSLER, DODGE TRUCK, JEEP

HB371

F | FMSI D841 | .600 [15]

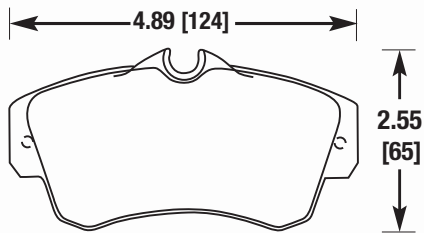

MERCEDES (REAR)

HB374

F, Y | FMSI D857 | .700 [18]

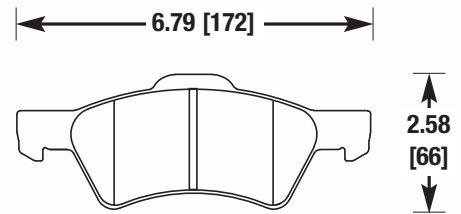

CHRYSLER, DODGE TRUCK

HB372

F, Y | FMSI D858 | .626 [16]

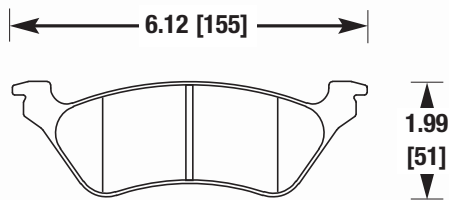

CHRYSLER, DODGE TRUCK (REAR)

HB375

F | FMSI D619 | .669 [17]

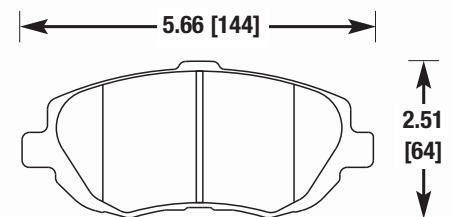

LEXUS, TOYOTA

HB376

F | FMSI D805 | .665 [17]
FMSI D849

6.43 [163]

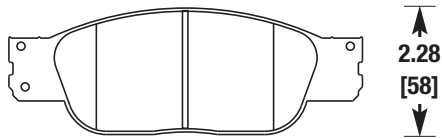

FORD, LINCOLN, JAGUAR

HB379

F, Y | FMSI D551 | .626 [16]

5.47 [139]

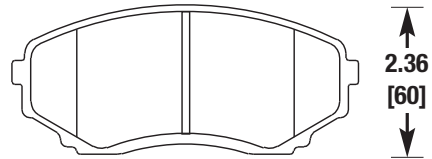

MAZDA MPV

HB377

F, Z, N, V | FMSI D841 | .760 [19]
S, E

4.89 [124]

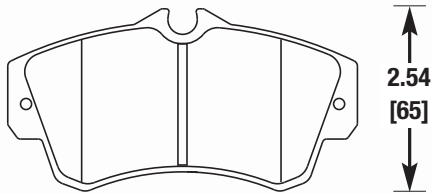

DODGE

HB380

F, Y | FMSI D790 | .700 [18]
FMSI D942

7.57 [192]



INNER

7.65 [194]

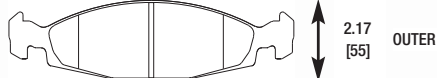

OUTER

JEEP GRAND CHEROKEE

HB378

F, Z, N | FMSI D900 | .565 [14]
S, E | FMSI D1008 | .626 [16]

4.15 [105]

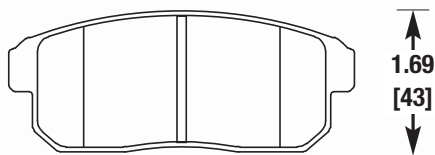

MAZDA RX-8, NISSAN (REAR)

HB381

F, Y | FMSI D791 | .661 [17]

5.48 [139]

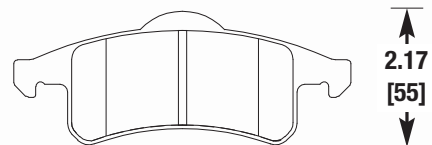

JEEP GRAND CHEROKEE (REAR)

HB382

F, Y | FMSI D882 | .657 [17]

6.96 [177]

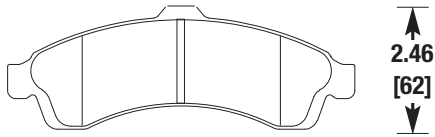

BUICK, CHEVYTRUCK, GMC, ISUZU, OLDS

HB385

F, Y | FMSI D834 | .640 [16]

7.22 [183]

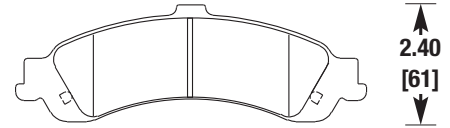

CADILLAC, CHEVY/GMC TRUCK (REAR)

HB383

F, Y | FMSI D883 | .685 [17]

5.42 [148]

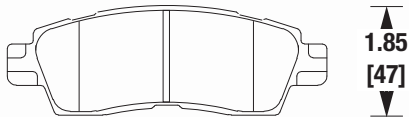

BUICK, CHEVYTRUCK, GMC, ISUZU, OLDS (REAR)

HB386

F, Y | FMSI D793 | .669 [17]

5.47 [139]

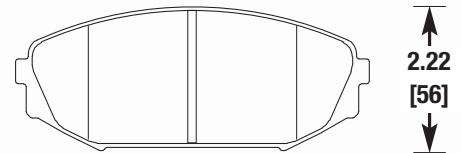

ACURA, HONDA

HB384

F, Y | FMSI D556
FMSI D807 | .587 [15]

4.59 [117]

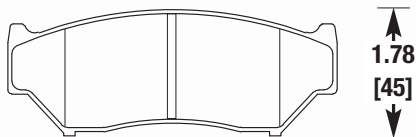

CHEVYTRUCK, GEO, SUZUKI

HB387

F, Z | FMSI D888 | .547 [14]

6.18 [157]

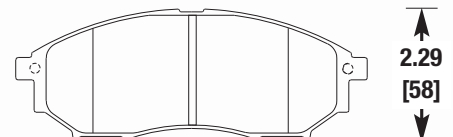

INFINITI

HB388

F | FMSI D819 | .756 [19]
FMSI D936

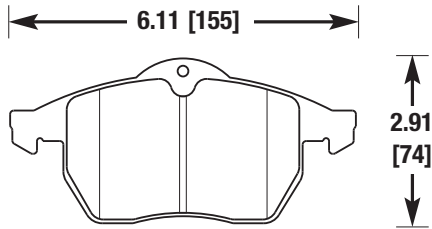

SAAB, SATURN

HB393

F, Y | FMSI D914 | .665 [17]
FMSI D943
FMSI D958

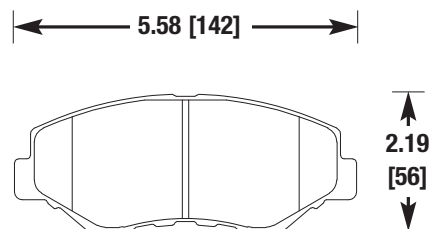

HONDA

HB389

F | FMSI D709 | .583 [15]

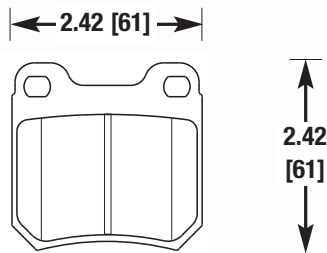

CADILLAC, SAAB, SATURN (REAR)

HB396

F | FMSI D215 | .630 [16]

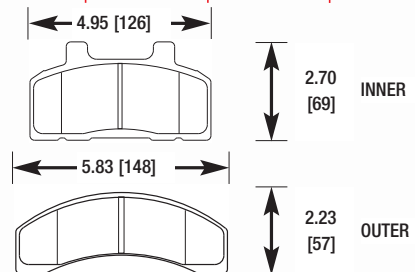

BUICK, CADILLAC, CHEVY, CHEVY TRUCK
OLDS, PONTIAC

HB390

F | FMSI D506 | .602 [15]
FMSI D673

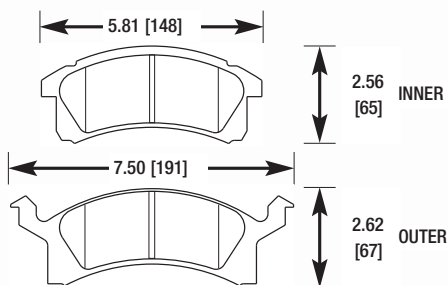

BUICK, CHEVROLET, OLDS, PONTIAC

HB397

F | FMSI D256 | .585 [15]

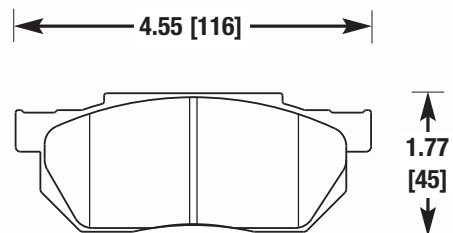

HONDA

HB398

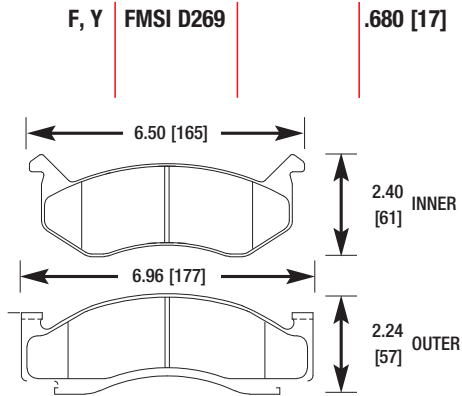

DODGE TRUCK

HB401

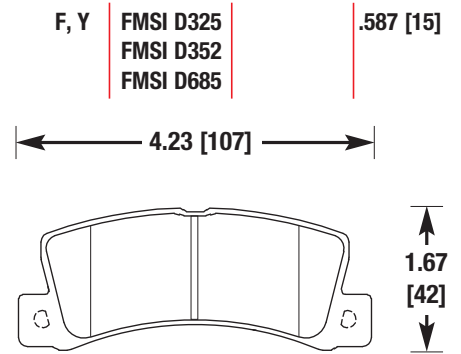

GEO, LEXUS, TOYOTA (REAR)

HB399

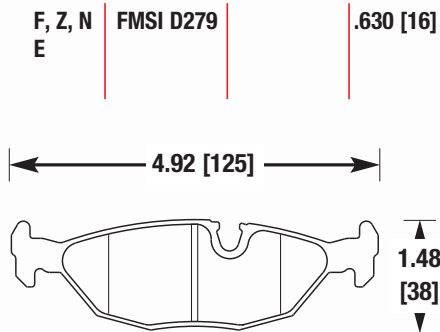

BMW (REAR)

HB402

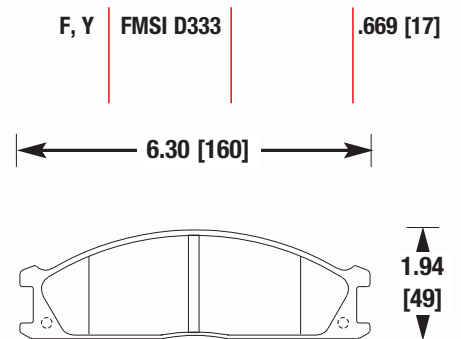

NISSAN TRUCK, SUBARU

HB400

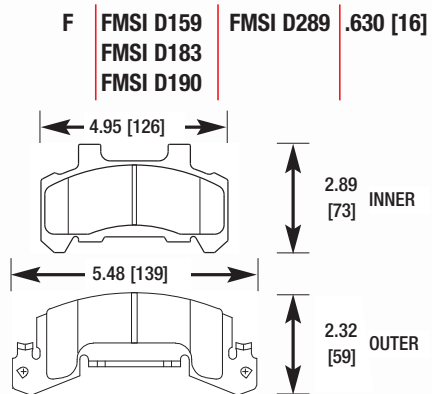

BUICK, CADILLAC, CHEVY, OLDS, PONTIAC

HB403

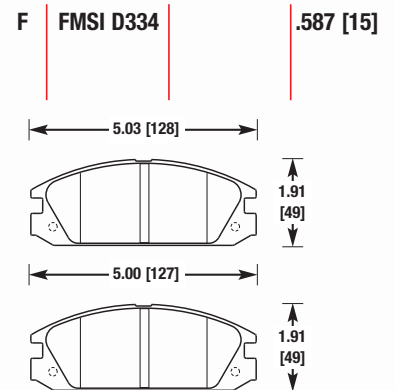

ACURA, HONDA

HB404

F, Y | FMSI D349 | .642 [16]

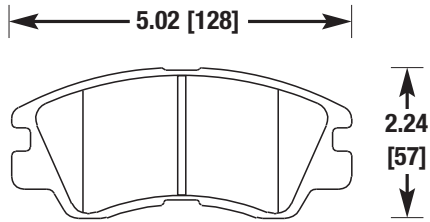

DODGE TRUCK, MITSUBISHI

HB408

F | FMSI D470 | .665 [17]

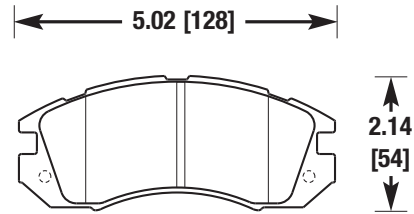

SUBARU

HB405

F | FMSI D377 | .543 [14]

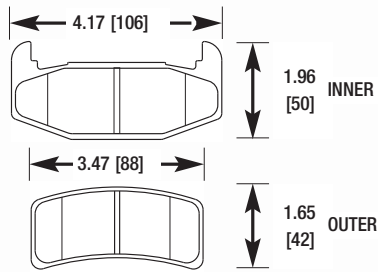

BUICK, CHEVROLET, OLDS, PONTIAC

HB409

F | FMSI D507
FMSI D728 | .661 [17]

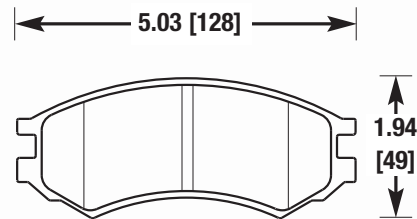

SATURN "S" SERIES

HB407

F, Y | FMSI D389
FMSI D433 | .602 [15]

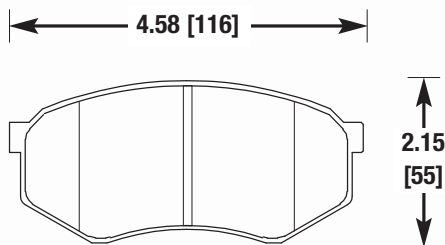

MAZDA, TOYOTA, TOYOTA TRUCK

HB410

F, Y | FMSI D0522 | .721 [18]

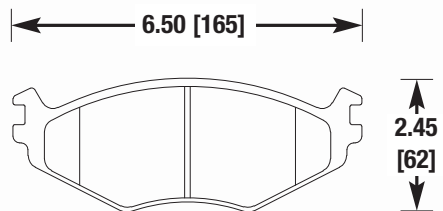

CHRYSLER, DODGE
DODGE TRUCK, PLYMOUTH

HB411

F, Y | FMSI D521 | .717 [18]
 FMSI D524

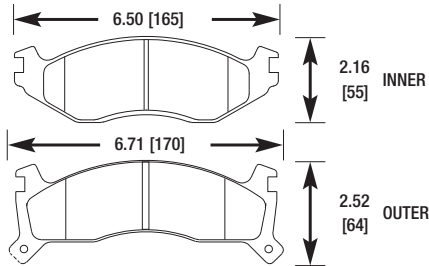

CHRYSLER, DODGE
 DODGE TRUCK, PLYMOUTH

HB415

F | FMSI D587 | .583 [15]

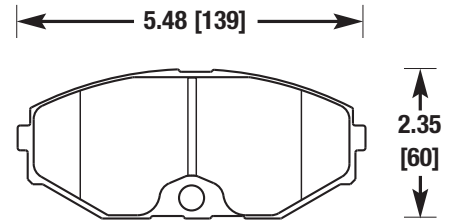

INFINITI

HB413

F | FMSI D0542 | .690 [18]

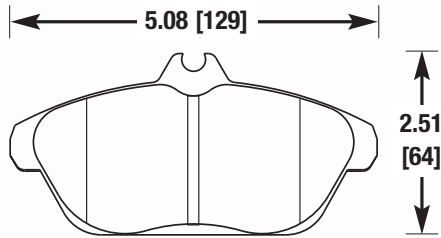

VOLVO

HB416

F | FMSI D598 | .689 [18]
 FMSI D765

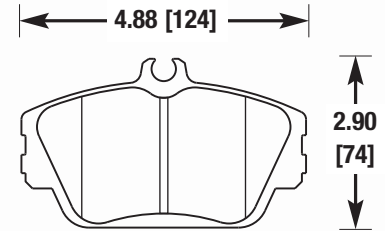

FORD, LINCOLN, MERCURY

HB414

F, Y | FMSI D576 | .622 [16]

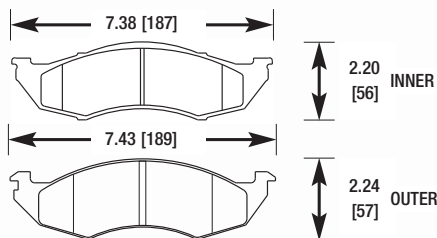

MERCURY, NISSAN TRUCK

HB417

F | FMSI D610 | .659 [17]

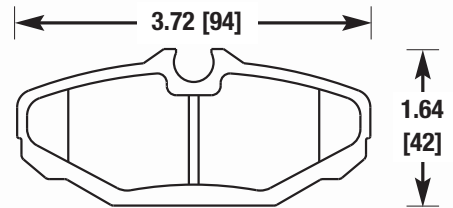

FORD, LINCOLN, MERCURY (REAR)

HB418

F, Z, N	FMSI D621	.646 [16]
S, E	FMSI D948	

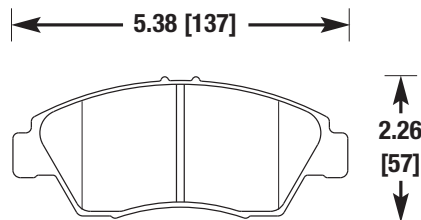

HONDA

HB421

F	FMSI D540	.622 [16]
	FMSI D595	

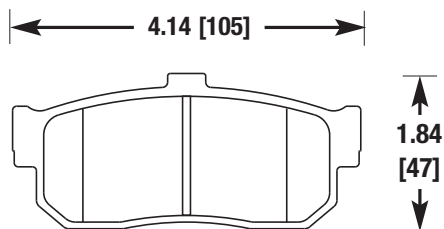

INFINITI, NISSAN (REAR)

HB419

F	FMSI D643	.634 [16]
---	-----------	-----------

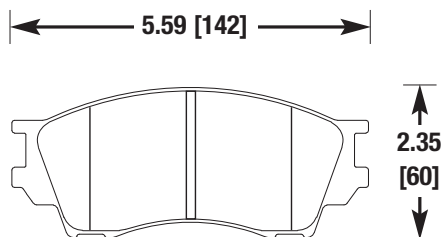

MAZDA MILLENIA

HB422

F, Y	FMSI D579	.610 [15]
------	-----------	-----------

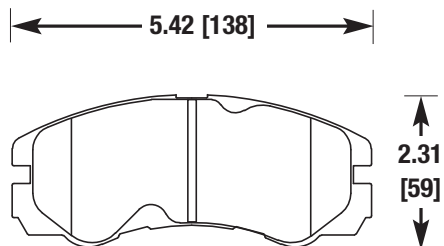

ACURA, HONDA, ISUZU

HB420

F	FMSI D648	.724 [18]
	FMSI D745	

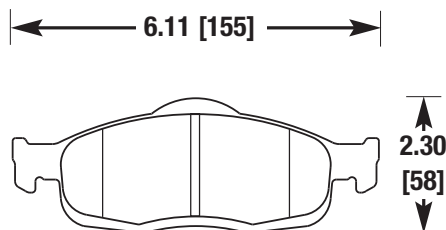

FORD, MERCURY

HB423

F	FMSI D720	.709 [18]
---	-----------	-----------

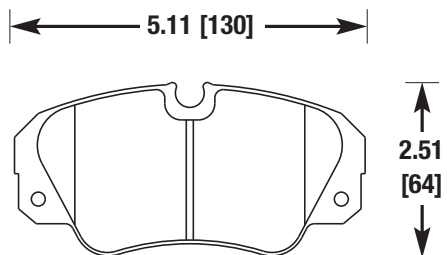

CADILLAC CATERA

HB424

F | FMSI D722 | .665 [17]

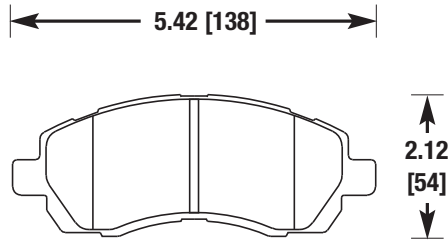

SUBARU

HB428

F | FMSI D806 | .650 [17]
FMSI D944

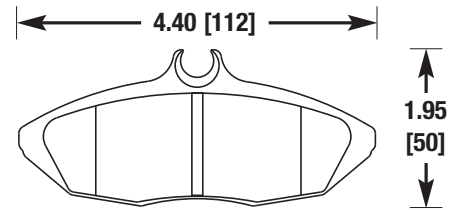

DODGE, FORD, JAGUAR
LINCOLN (REAR)

HB425

F | FMSI D727 | .661 [17]
FMSI D752

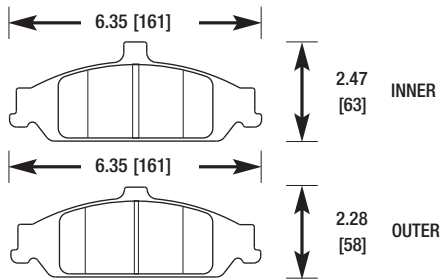

CHEVROLET, OLDS, PONTIAC

HB429

F, Y | FMSI D862 | .681 [17]

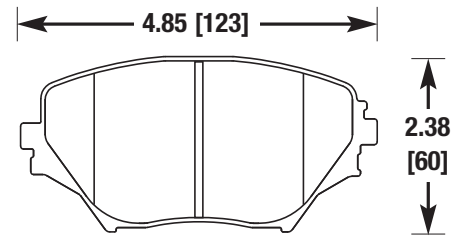

TOYOTA RAV-4 (FRONT)

HB427

F, Y | FMSI D773 | .685 [17]

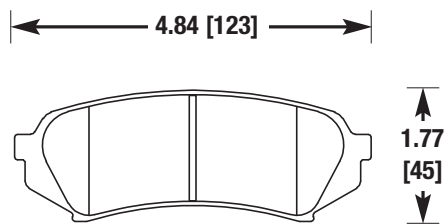

LEXUS, TOYOTA TRUCK (REAR)

HB430

F, Z, N, S | FMSI D886 | .547 [14]
E

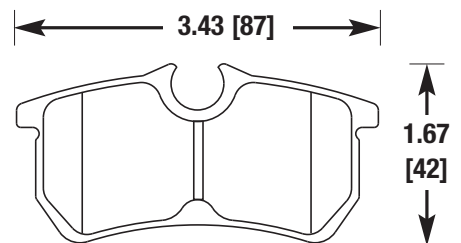

FORD FOCUS (REAR)

HB431

F, Z, N, V | FMSI D890 | .606 [15]
S, E

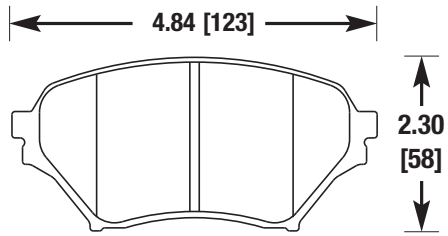

MAZDA MIATA

HB434

F, Z, N, U | FMSI D770 | .543 [14]
G, S, E

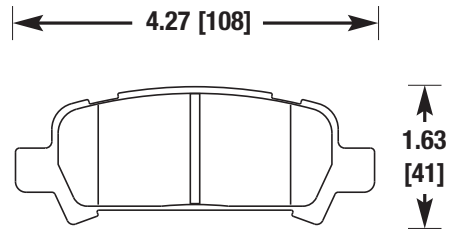

SUBARU (REAR)

HB432

F, Z, N, G | FMSI D929 | .661 [17]
S, E

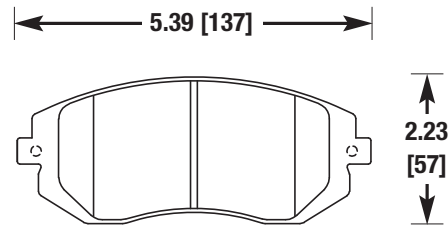

SUBARU

HB435

F, Y | FMSI D866 | .622 [16]

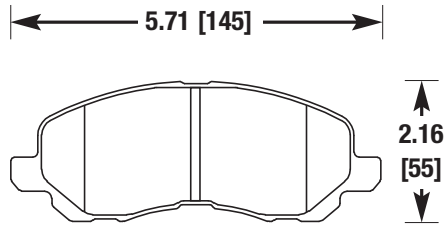

CHRYSLER, DODGE, MITSUBISHI

HB433

F | FMSI D931 | .654 [17]
FMSI D997

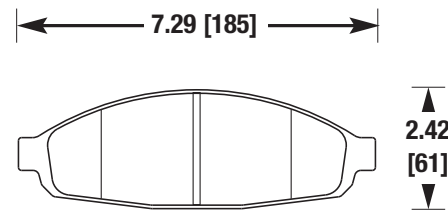

CHRYSLER, FORD, LINCOLN, MERCURY

HB436

F, Z, N | FMSI D892 | .535 [14]

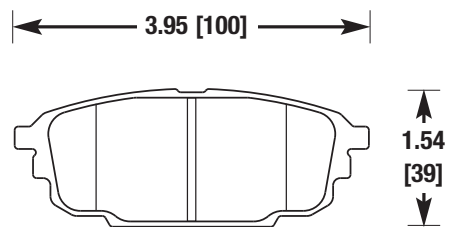

MAZDA PROTEGE (REAR)

HB437

F | FMSI D481 | .585 [15]
FMSI D588

4.28 [109]

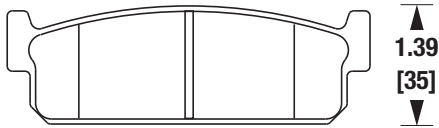

INFINITI (REAR)

HB440

F, Z | FMSI D922 | .606 [15]

4.82 [122]

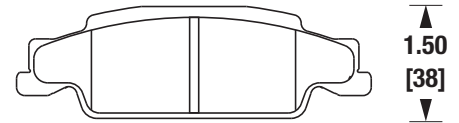

CADILLAC CTS, STS (REAR)

HB438

F, Z | FMSI D904 | .606 [15]

4.49 [114]

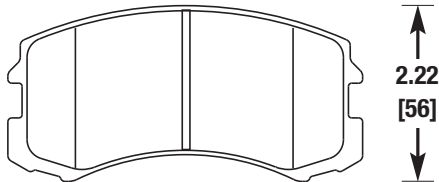

MITSUBISHI LANCER

HB441

F, Z | FMSI D923 | .661 [17]

4.83 [123]

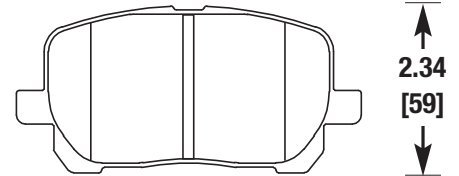

PONTIAC, TOYOTA

HB439

F, Z | FMSI D921 | .555 [14]
FMSI D1110

7.18 [182]

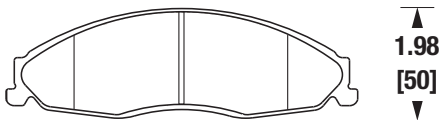

CADILLAC CTS, STS

HB442

F, N, S, E | FMSI D891 | .496 [13]

4.01 [102]

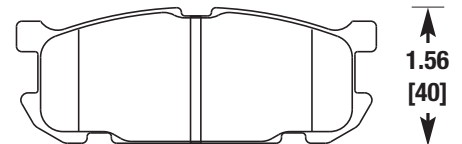

MAZDA MIATA (REAR)

HB443

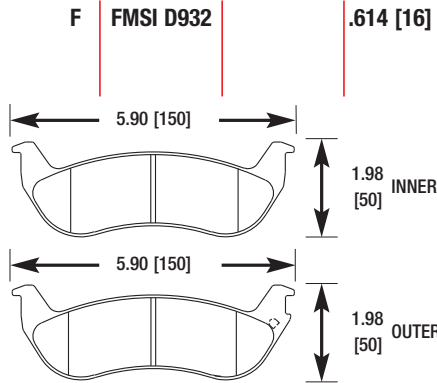

FORD, LINCOLN, MERCURY (REAR)

HB446

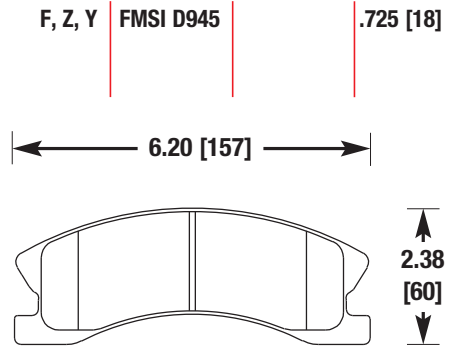

JEEP GRAND CHEROKEE

HB444

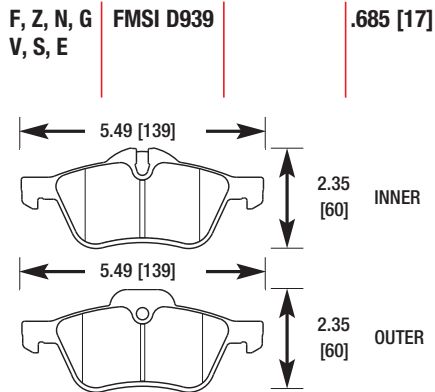

MINI COOPER

HB447

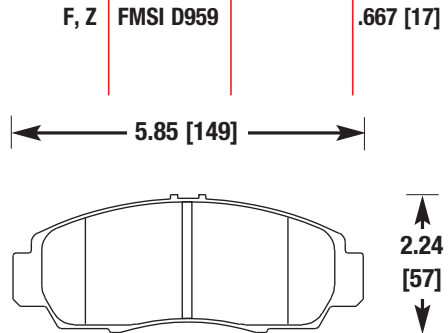

HONDA ACCORD

HB445

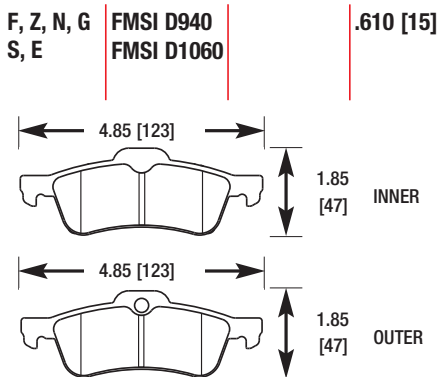

MINI COOPER (REAR)

HB448

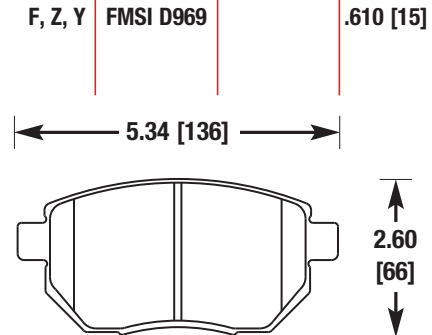

INFINITI, NISSAN, NISSAN TRUCK

HB449

F, Z, N, E | FMSI D970 | .679 [17]

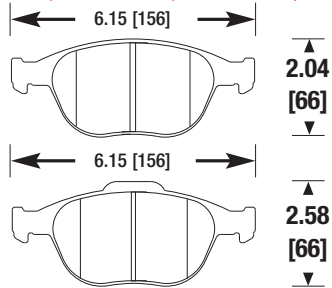

MAZDA

HB452

F, Z, N, S | FMSI D1004 | .545 [14]
E

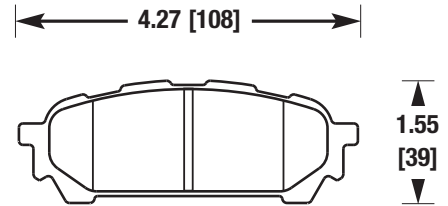

SUBARU (REAR)

HB450

F, Z | FMSI D999 | .555 [14]

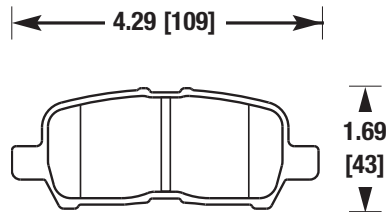

PONTIAC GRAND PRIX (REAR)

HB453

F, Z, N, U | FMSI D1001 | .585 [15]
G, W, V, S | FMSI D1016
E | FMSI D1050

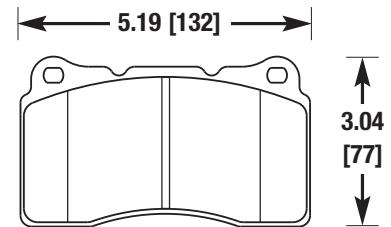

MITSUBISHI EVO, SUBARU IMPREZA

HB451

F, Z | FMSI D1000 | .668 [17]

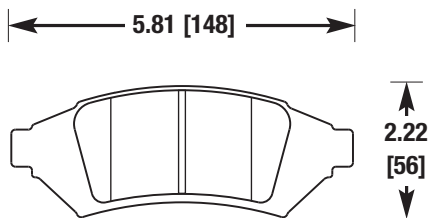

PONTIAC GRAND PRIX

HB454

F, Y | FMSI D992 | .715 [18]

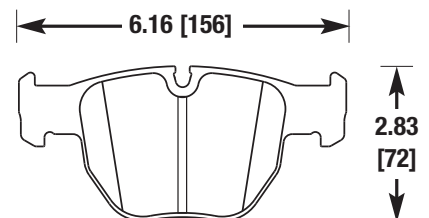

RANGE ROVER

HB455

F, Z, Y | FMSI D1011 | .785 [20]
FMSI D1083

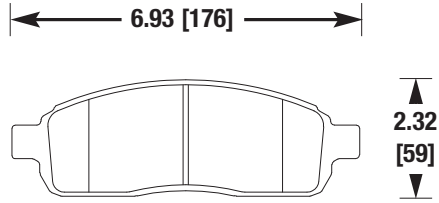

FORD TRUCK

HB458

F, Z | FMSI D1042 | .642 [16]

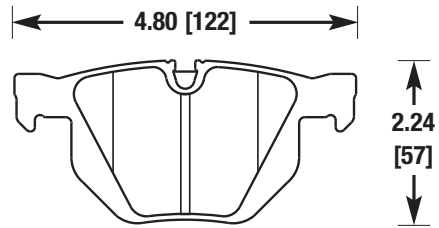

BMW 525i

HB456

F, Z, Y | FMSI D1012 | .705 [18]

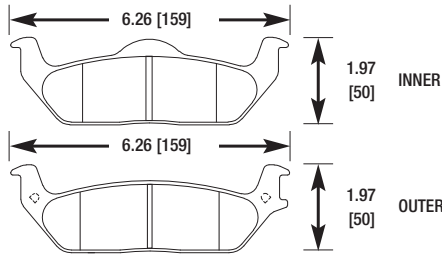

FORD F-150 (REAR)

HB459

F, Z, N | FMSI D957 | .700 [18]

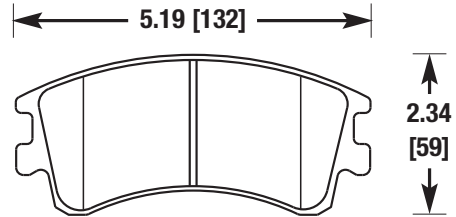

MAZDA 6

HB457

F, Z | FMSI D1037 | .605 [15]

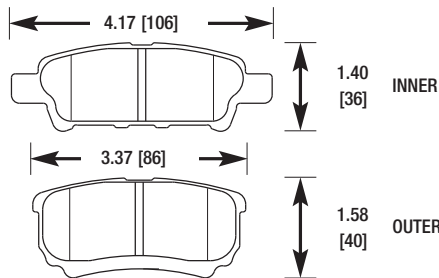

MITSUBISHI LANCER (REAR)

HB460

F, Z, N | FMSI D1043 | .580 [15]

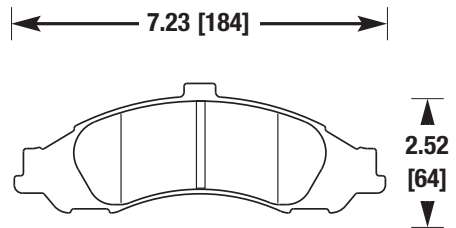

PONTIAC GTO

HB461

F, Z, Y	FMSI D864	FMSI D1013	.646 [16]
	FMSI D903		
	FMSI D955		

HYUNDAI, KIA

HB464

F, Z, N, U	FMSI D946	.764 [19]
G, V, S, E		

BMW

HB462

F, Z, Y	FMSI D934	.827 [21]
---------	-----------	-----------

FORD TRUCK, LINCOLN

HB465

F, Z	FMSI D947	.764 [19]
------	-----------	-----------

BMW 525i

HB463

F, Z, Y	FMSI D935	.787 [20]
---------	-----------	-----------

FORD TRUCK, LINCOLN (REAR)

HB466

Z	FMSI D1003	.780 [20]
---	------------	-----------

VOLVO XC90

HB467

F, Z | FMSI D1019 | .540 [14]

7.11 [181]

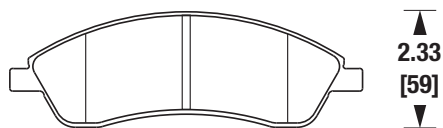

CADILLAC SRX

HB470

F, Z, N, G | FMSI D1009 | .643 [16]
V, S, E

5.44 [138]

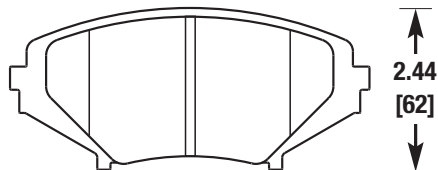

MAZDA RX-8

HB468

F, Z, N, S | FMSI D1002 | .492 [12]
E

4.02 [102]

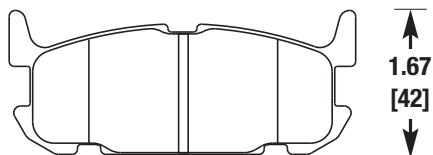

MAZDA MIATA

HB471

F, Z, N, U | FMSI D11 | .510 [13]
S

5.08 [129]

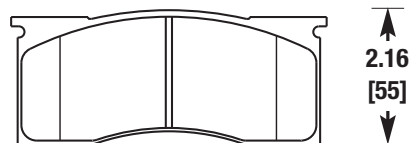

DODGE, PLYMOUTH

HB469

F, Y | FMSI D676 | .705 [18]

5.70 [145]

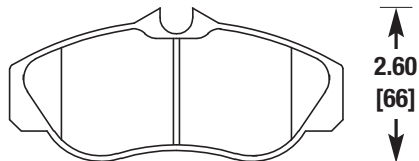

LAND ROVER DISCOVERY

HB472

F, Z, Y | FMSI D913 | .650 [17]
FMSI D833

6.06 [154]

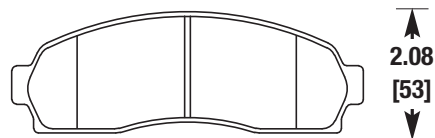

CHEVY TRUCK, FORD TRUCK, MAZDA TRUCK,
MERCURY, SATURN

HB473

F, Z, Y | FMSI D843 | .752 [19]

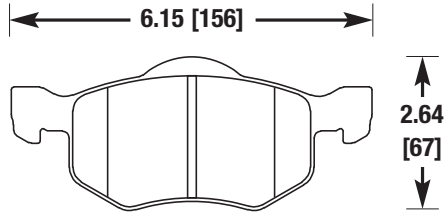

FORD TRUCK, MAZDA TRUCK

HB476

F, Y | FMSI D962 | .707 [18]

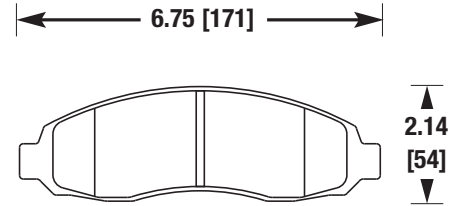

DODGE DAKOTA

HB474

F, Z | FMSI D908 | .681 [17]

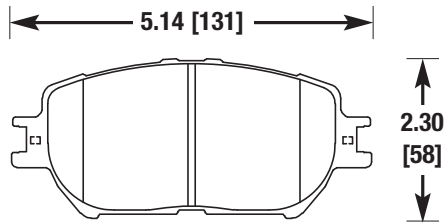

TOYOTA CAMRY

HB477

F | FMSI D606 | .610 [15]

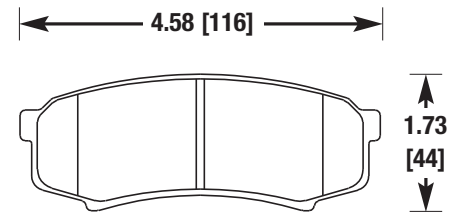

LEXUS, TOYOTA (REAR)

HB475

F, Z, E | FMSI D266 | .642 [16]
FMSI D441

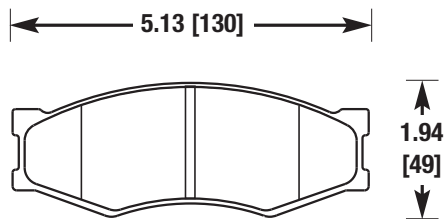

NISSAN

HB478

F, Z, N, G | FMSI D1095 | .605 [15]
S, E | FMSI D973

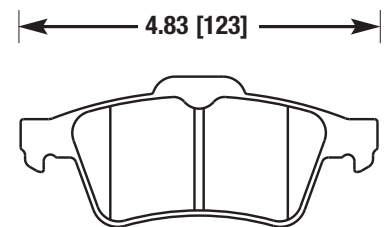

MAZDA 3, SOLSTICE (REAR)

HB479

P | FMSI D928 | .700 [18]

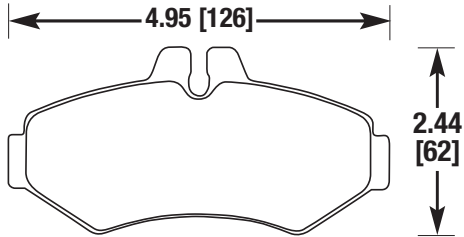

DODGE TRUCK, FREIGHTLINER (REAR)

HB483

F, U, G, S | FMSI D991 | .635 [16]

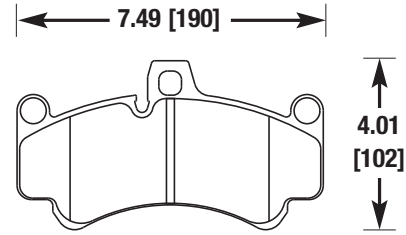

PORSCHE

HB480

P | FMSI D949 | .750 [19]

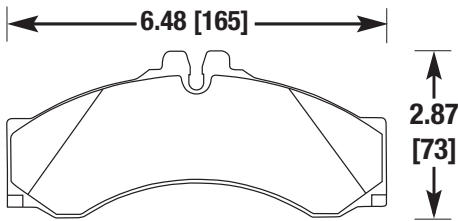

DODGE TRUCK, FREIGHTLINER

HB484

F, Z, N, U | FMSI D1081 | .670 [17]
G, V, S, E

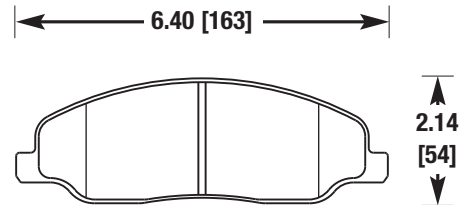

MUSTANG

HB481

P | FMSI D1006 | .750 [19]

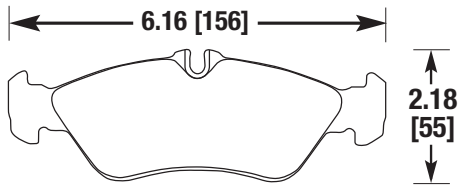

DODGE TRUCK, FREIGHTLINER (REAR)

HB485

F, Z, N, G | FMSI D1082 | .656 [17]
S, E

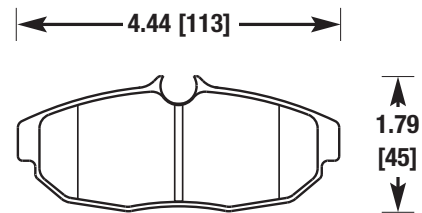

MUSTANG (REAR)

HB487

F, Y | FMSI D859 | .733 [19]
FMSI D821

8.66 [220]

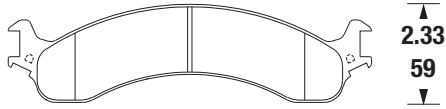

DODGE TRUCK

HB490

F, Z, Y, P | FMSI D976 | .665 [17]

5.30 [135]

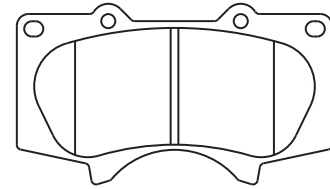

LEXUS, TOYOTA

HB488

F, Z, Y | FMSI D830 | .629 [16]

6.46 [164]

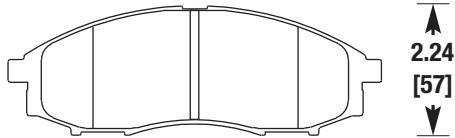

NISSAN TRUCK

HB491

F, Z | FMSI D794 | .693 [18]

6.10 [155]

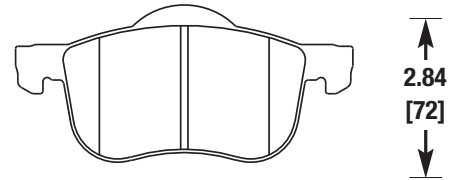

VOLVO

HB489

F, Z | FMSI D755 | .630 [16]

5.18 [132]

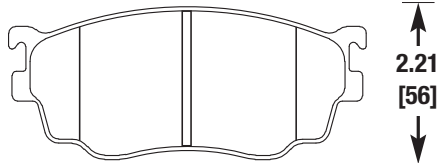

MAZDA 626

HB492

F, Z | FMSI D618 | .732 [19]

6.16 [156]

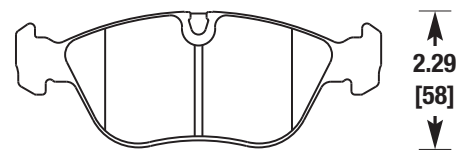

VOLVO

HB493

F, Z, E | FMSI D822 | .650 [17]
FMSI D990

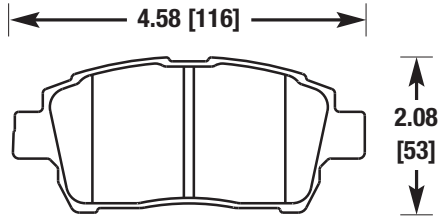

SCION, TOYOTA

HB496

F, Z, Y | FMSI D975 | .640 [16]

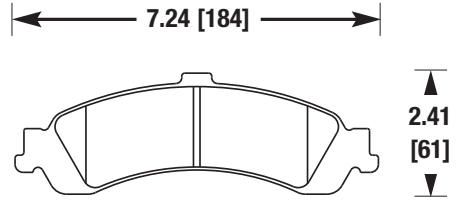

CADILLAC, CHEVY TRUCK, GMC TRUCK (REAR)

HB494

F, Z, Y | FMSI D974 | .670 [17]

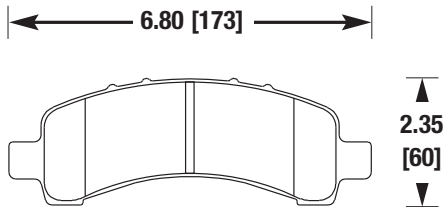

CADILLAC, CHEVY TRUCK, GMC TRUCK (REAR)

HB497

F, Z, U, S | FMSI D682 | .776 [20]

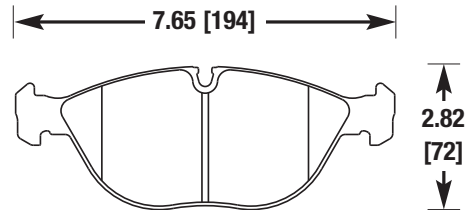

BMW

HB495

F, Z | FMSI D740 | .756 [19]

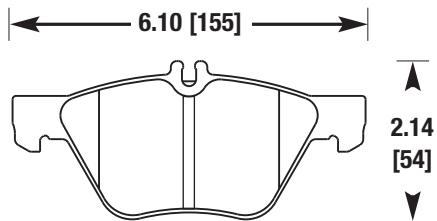

MERCEDES BENZ

HB498

F, Z | FMSI D869 | .772 [20]

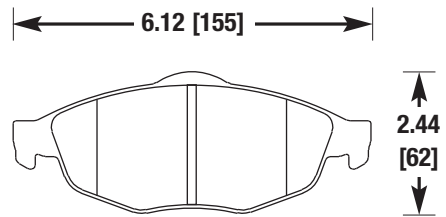

CHRYSLER, DODGE

HB499

F, Z | FMSI D771 | .610 [15]

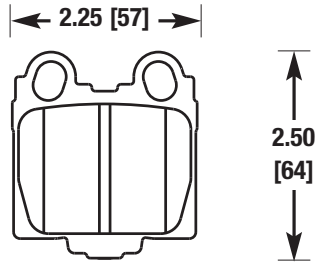

LEXUS (REAR)

HB502

F, Z, Y, N | FMSI D978 | .606 [15]

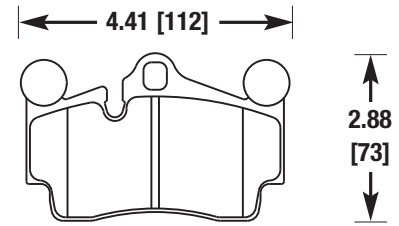

PORSCHE, VOLKSWAGEN

HB500

F, Z | FMSI D837 | .645 [16]

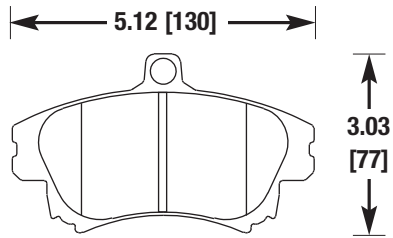

VOLVO S40

HB503

F, Y | FMSI D963 | .790 [20]

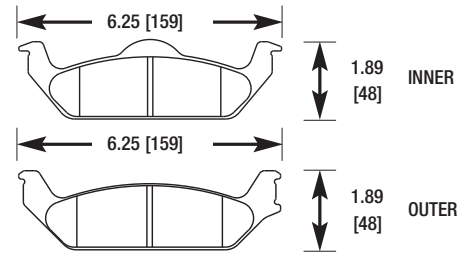

DODGE DAKOTA (REAR)

HB501

F, Z, Y, G
E | FMSI D977
FMSI D1014 | .625 [16]

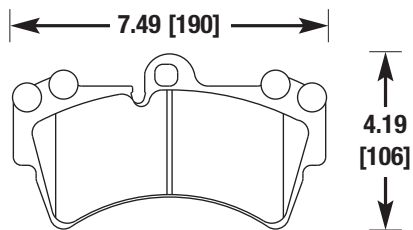

PORSCHE

HB504

F, Z | FMSI D872 | .740 [19]

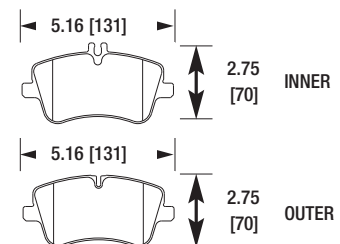

MERCEDES BENZ

HB505

F, Z, Y | FMSI D760 | .654 [17]

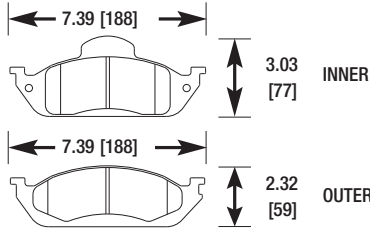

MERCEDES BENZ

HB508

F, Z | FMSI D1057 | .586 [15]
.675 [17]

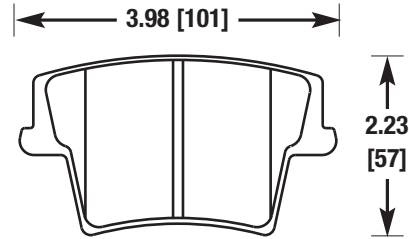

CHRYSLER, DODGE (REAR)

HB506

F, Z | FMSI D865 | .610 [15]

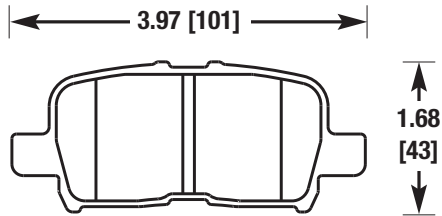

ACURA, HONDA (REAR)

HB509

F, Z | FMSI D1058 | .678 [17]

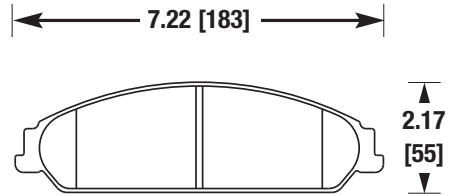

CHRYSLER, DODGE

HB507

F, Z | FMSI D1056 | .711 [18]

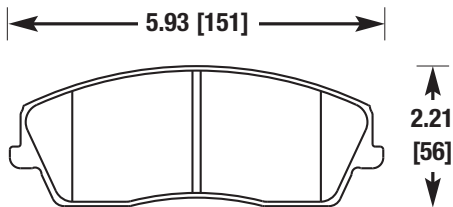

CHRYSLER, DODGE

HB510

F | FMSI D661 | .580 [15]

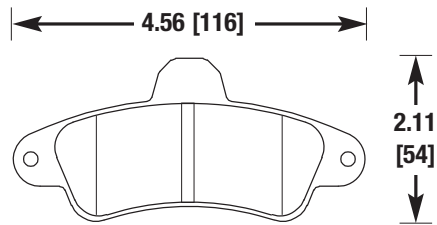

FORD MERCURY (REAR)

HB511

F, Y | FMSI D1010 | .790 [20]

11.34 [288]

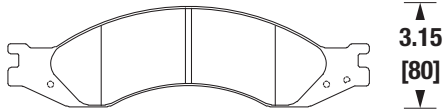

GMC TRUCK

HB514

F, Y, P | FMSI D898 | .610 [15]

6.55 [166]

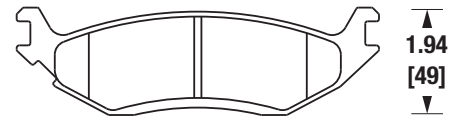

DODGE VAN (REAR)

HB512

F, Z, Y | FMSI D1007 | .605 [15]

7.49 [190]

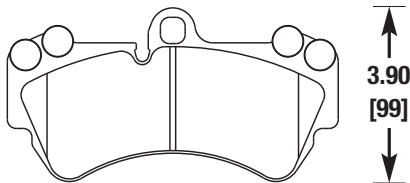

VOLKSWAGEN TOUAREG

HB515

F, Z, N | FMSI D915 | .760 [19]

6.11 [155]

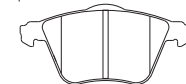

2.87 [73] INNER

6.11 [155]



2.87 [73] OUTER

AUDI, VOLVO

HB513

F, Y | FMSI D967 | .610 [15]

6.55 [166]

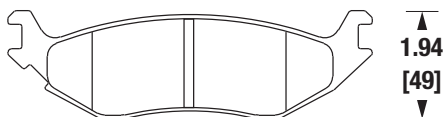

DODGE TRUCK (REAR)

HB516

F, Z | FMSI D838 | .626 [16]

3.43 [87]

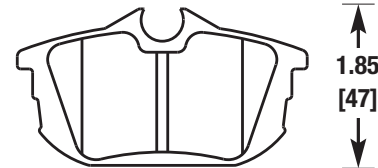

VOLVO (REAR)

HB517

F, Z | FMSI D956 | .690 [18]

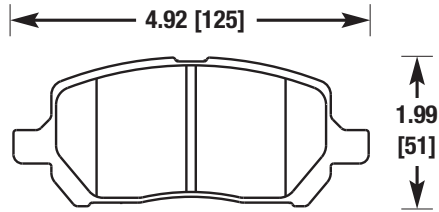

CHEVEROLET, PONTIAC, SATURN

HB520

F, Z, Y | FMSI D881 | .618 [16]

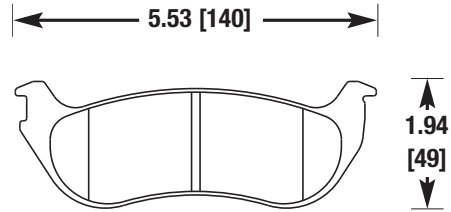

FORD EXPLORER (REAR)

HB518

F, Z, Y, N | FMSI D683 | .642 [16]
U, G, S, E

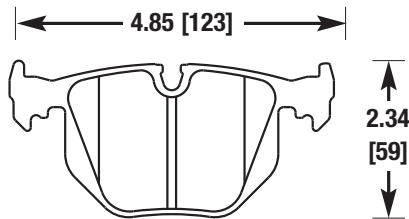

BMW (REAR)

HB521

F, N, U, G | .650 [17]
W, H, S, L | .800 [20]
M

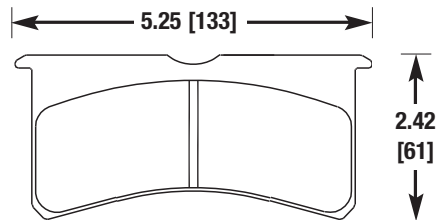

WILWOOD BRIDGE-BOLT SUPERLITE

HB519

F, N, G, V | FMSI D1044 | .682 [17]
S, E

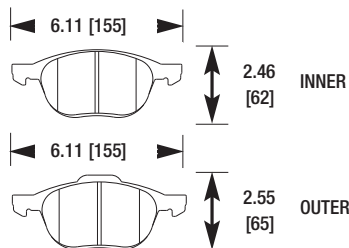

MAZDA 3

HB522

F, N, U, G | FMSI D1179 | .565 [14]
S, E

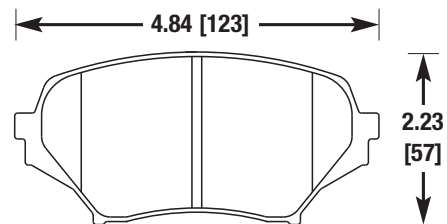

MAZDA MIATA MX-5 06-08

HB523

F, N, G, S | FMSI D1180 | .539 [14]
E

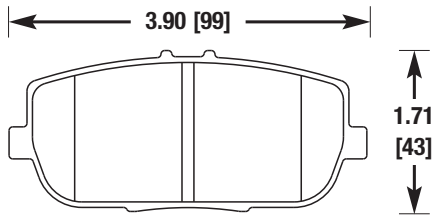

MIATA MX-5 (REAR)

HB526

Z, Y | FMSI D1119 | .665 [17]

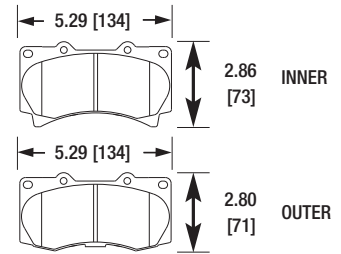

HUMMER H3 (FRONT)

HB524

F, Z, N, U | FMSI D1028 | .740 [19]
G, S, E

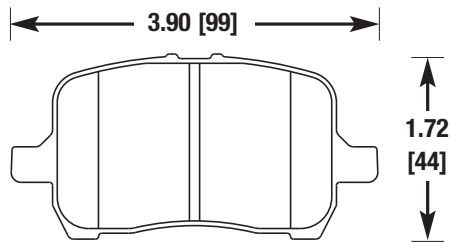

COBALT, SOLSTICE

HB527

Z, Y | FMSI D1120 | .604 [15]

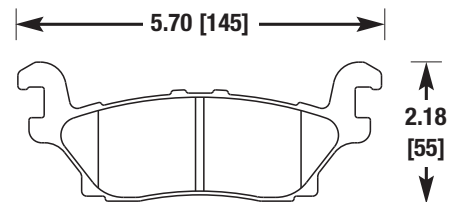

HUMMER H3 (REAR)

HB525

F, Z, N, G | FMSI D1033 | .540 [14]

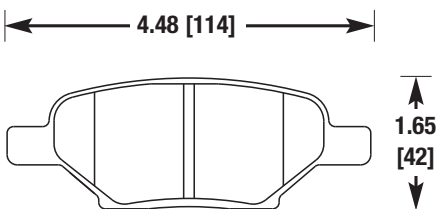

COBALT

HB528

Y, P | FMSI D1069 | .811 [21]

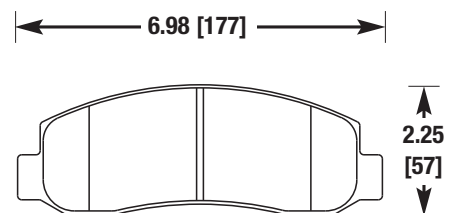

FORD F250/F350 SUPER DUTY

HB529

Y, P | FMSI D1068 | .710 [18]

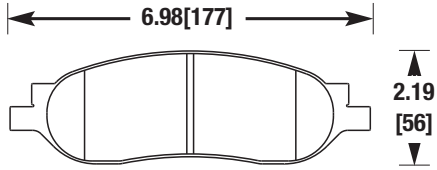

FORD TRUCK (REAR)

HB532

F, Z, N, U | FMSI D1185 | .570 [14]
G

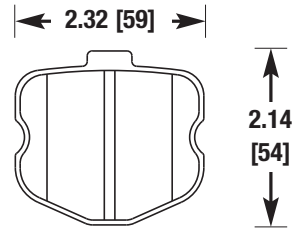

CORVETTE Z06 (REAR)

HB530

F, Z, N | FMSI D1049 | .570 [14]

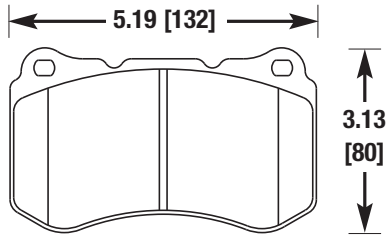

ACURA

HB533

F, Z, N, U | FMSI D1078 | .668 [17]
G

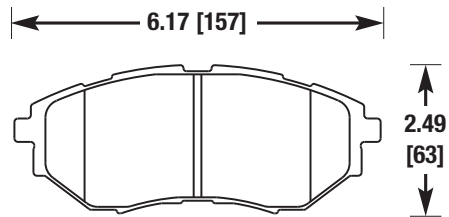

SUBARU

HB531

F, Z, N, U | FMSI D1185 | .570 [14]

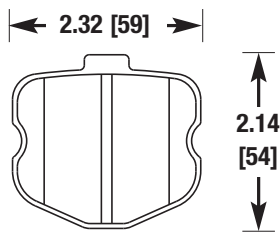

CORVETTE Z06 (FRONT)

HB534

F, Z, N | FMSI D1061 | .750 [19]

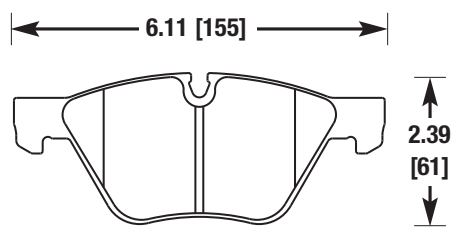

BMW

HB535

F | FMSI D1159 | .638 [16]

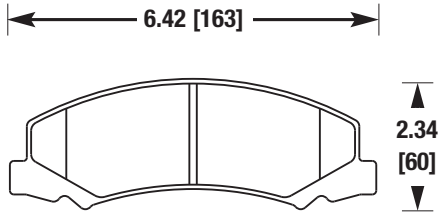

BUICK

HB538

F, Z, N | FMSI D1111 | .760 [19]

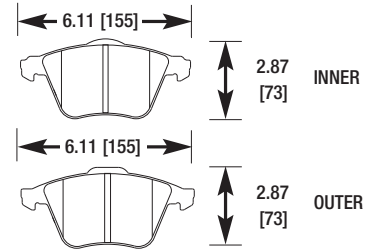

AUDI

HB536

F | FMSI D1076 | .704 [18]

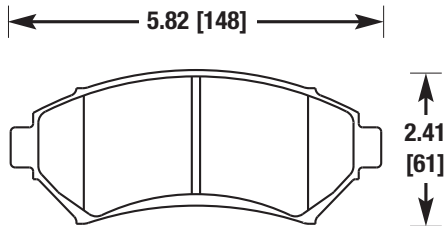

CADILLAC, CHEVY

HB539

F, Y | FMSI D0802 | .650 [17]

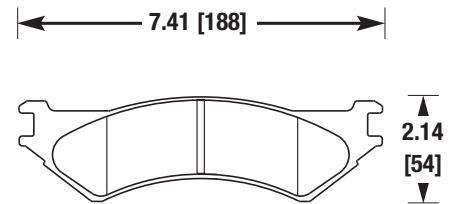

CHEVY IMPALA

HB537

F, Y | FMSI D0825 | .783 [20]

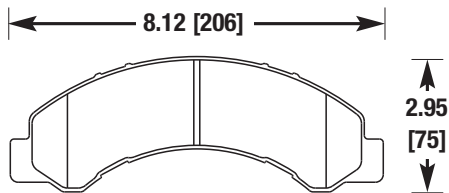

GMC / ISUZU TRUCK

HB540

F, U, G, W | .490 [12]
H, S, E, M
J

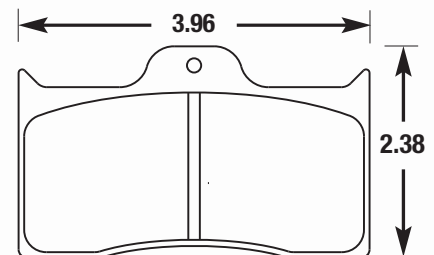

WILWOOD

HB541

F, U, G, W
H, S, E

.490 [12]
.630 [16]

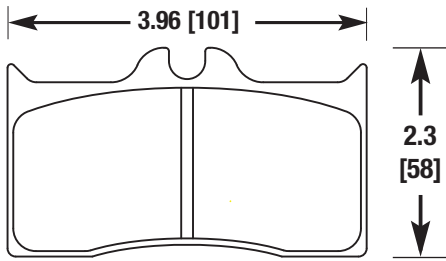

WILWOOD

HB544

F, Z, N | FMSI D1108

.628 [16]

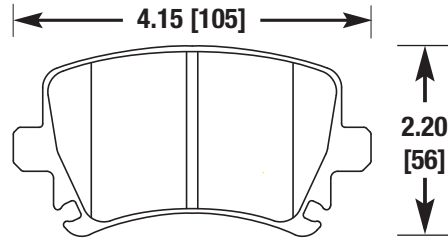

AUDI, VOLKSWAGEN

HB542

F, U, G, W
H, S, E, M
J

FMSI D1006

.600 [15]

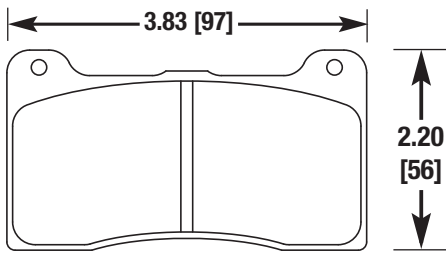

WILWOOD

HB545

F, Z, N | FMSI D960

.564 [14]

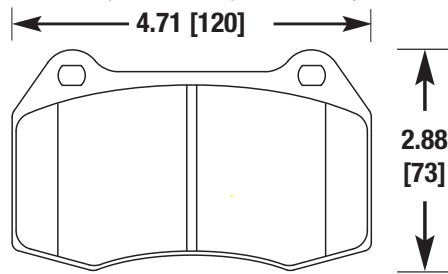

NISSAN 350Z W/BREMBO,
INFINITI G35 COUPE W/BREMBO

HB543

F, Z, N | FMSI D1107

.760 [19]

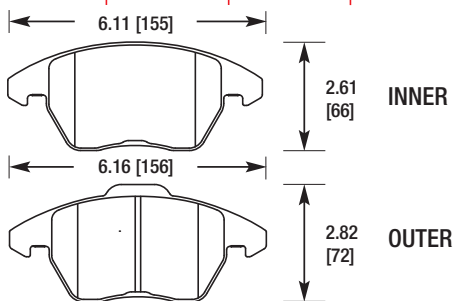

AUDI, VOLKSWAGEN

HB546

F, Z, N | FMSI D781

.654 [17]

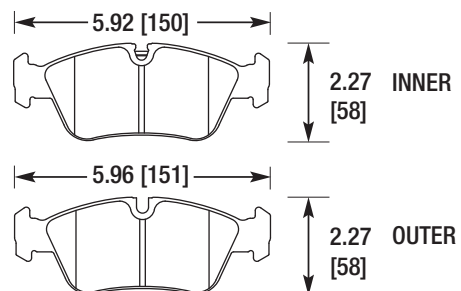

BMW Z4 ROADSTER, BMW 3 SERIES

HB547

Y, P | FMSI D1066 | .798 [20]

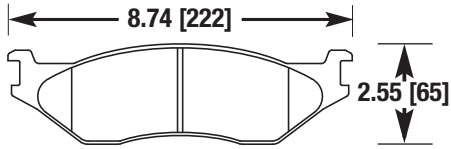

FORD F-450

HB550

F, Z, N, U | FMSI D917 | .634 [16]
G, S, E

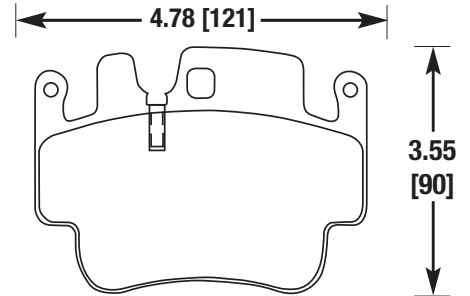

PORSCHE 911, BOXSTER, CAYMAN

HB548

G | FMSI D1066 | .600 [15]

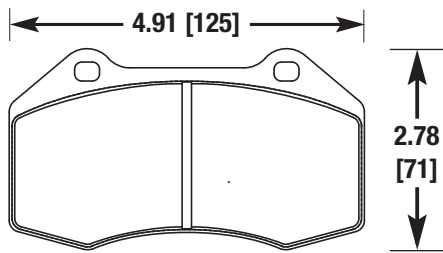

BREMBO

HB551

Y | FMSI D918 | .748 [19]
FMSI D1260

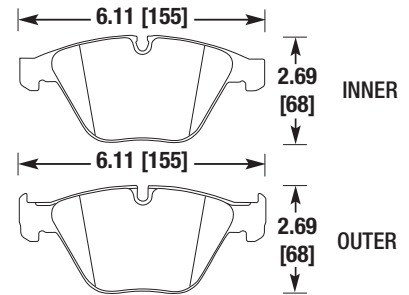

BMW

HB549

F, Z, N | FMSI D1186 | .702 [18]

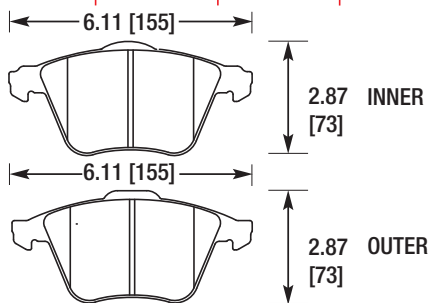

MAZDASPEED 3 AND 6

HB552

F, Y | FMSI D965 | .722 [18]

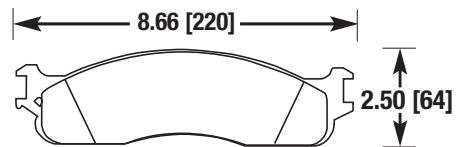

DODGE RAM PICKUP

HB553

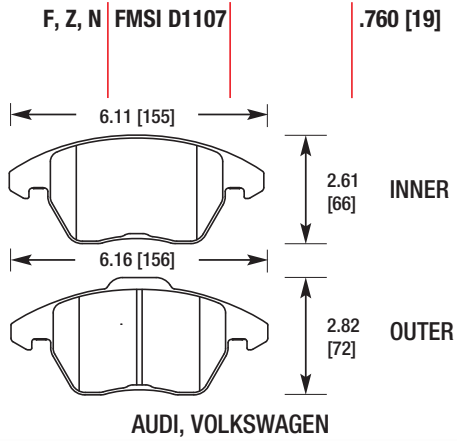

HB556

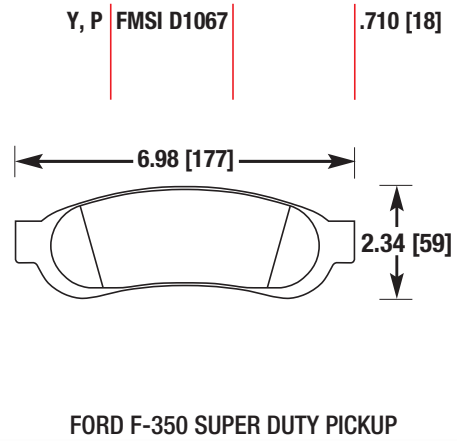

HB554

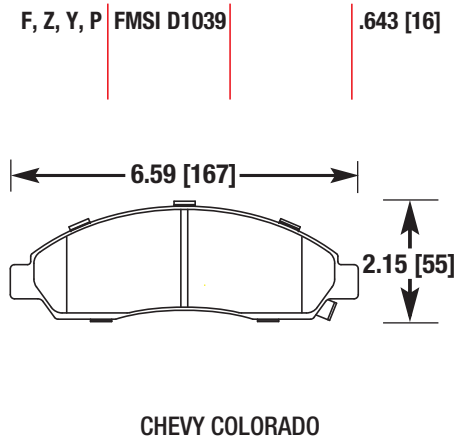

HB557

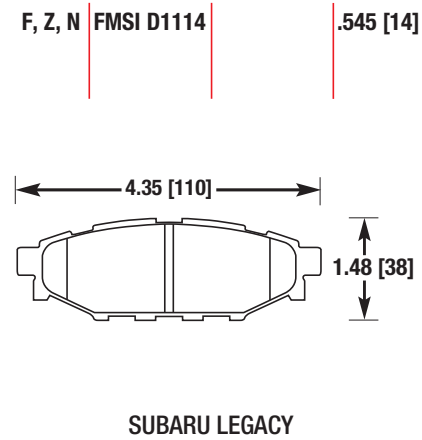

HB555

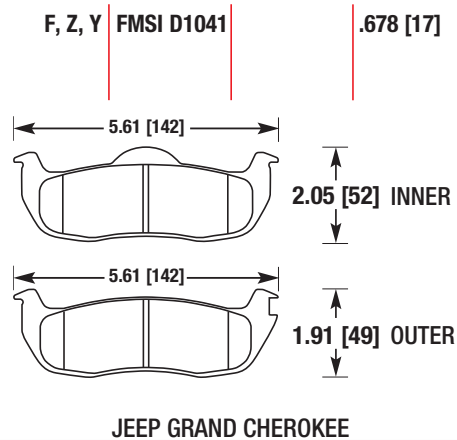

HB558

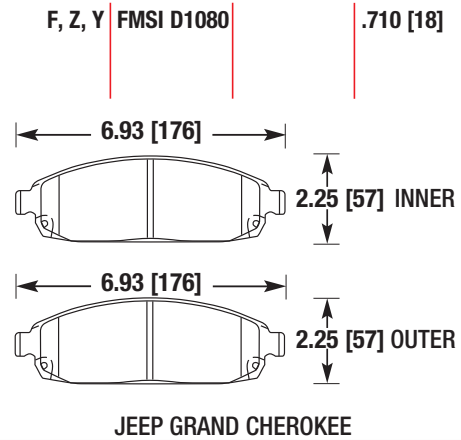

HB559

F, Y | FMSI D1084 | .695 [18]

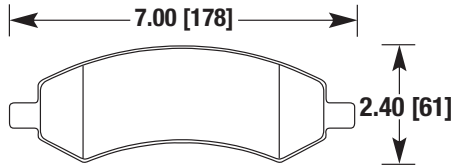

DODGE DAKOTA

HB562

F, Z, N | FMSI D1113 | .612 [16]

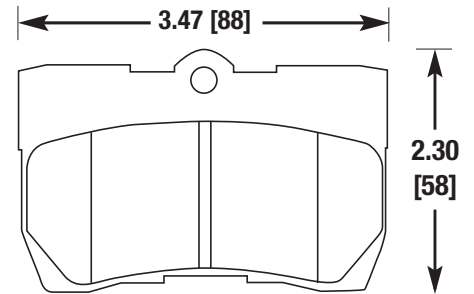

LEXUS IS250

HB560

F, Z, N, G | FMSI D1204 | .677 [17]

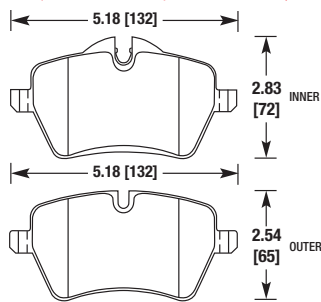

MINI COOPER (REAR)

HB563

F, Z, Y, N | FMSI D1149 | .656 [17]

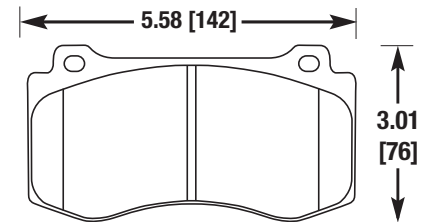

CHRYSLER, DODGE, JEEP

HB561

F, Z, Y, P | FMSI D1092 | .710 [18]

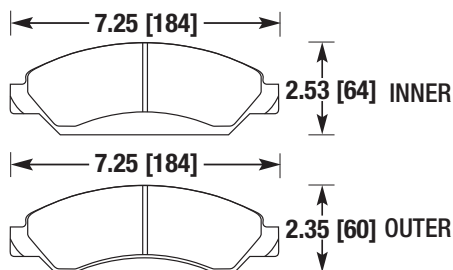

CHEVROLET SILVERADO

HB564

F, Z, N | FMSI D1161 | .567 [14]

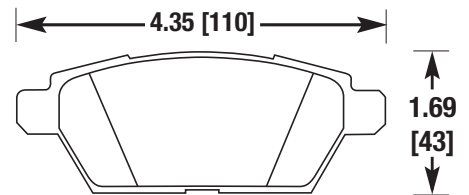

FORD FUSION

HB565

F, Z, N | FMSI D1164 | .688 [17]

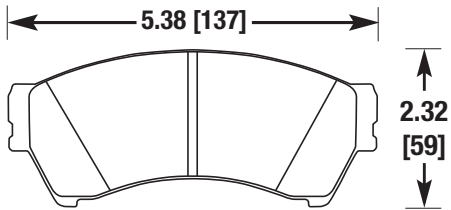

FORD FUSION

HB568

F, Z, Y, P | FMSI D1194 | .666 [17]

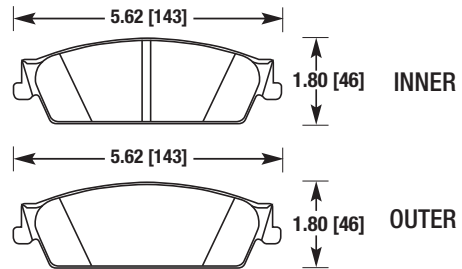

CADILLAC ESCALADE

HB566

F, Z, N | FMSI D1178 | .688 [17]

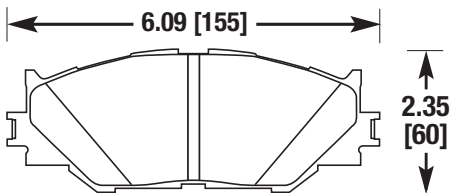

LEXUS IS250

HB569

F, Z, Y | FMSI D1273 | .650 [17]

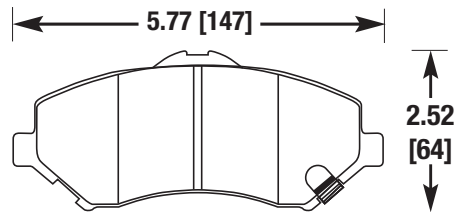

JEEP WRANGLER RUBICON

HB567

F, Z, Y | FMSI D1183
FMSI D1063 | .694 [18]

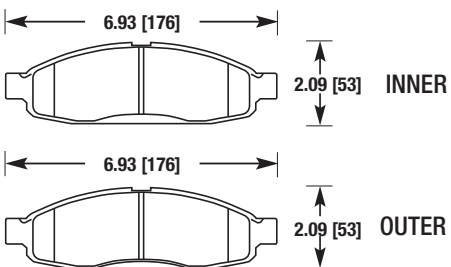

NISSAN TITAN

HB570

F, Z, N | FMSI D1308 | .666 [17]

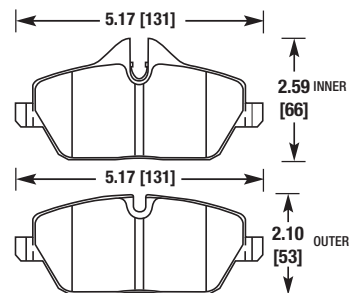

MINI COOPER STANDARD BRAKES

HB571

F, Z, N, G | FMSI D973 | .605 [15]
S, E

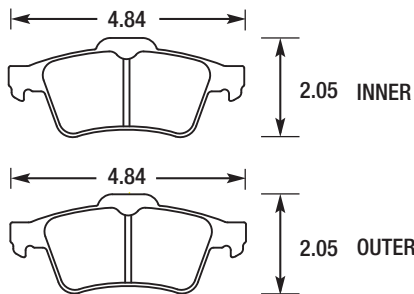

MAZDA 3 (REAR)

HB574

F, Z, N, G | FMSI D1309 | .636 [16]
S, E

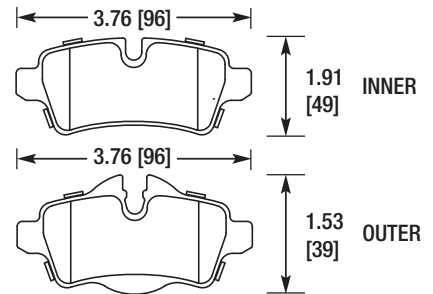

MINI COOPER (REAR)

HB572

F, Z, Y, N | FMSI D536 | .570 [14]

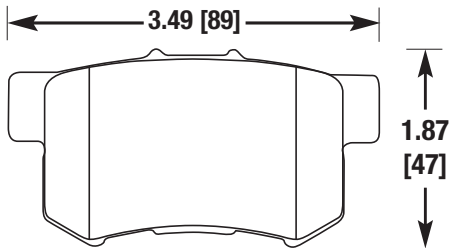

HONDA (REAR)

HB575

P | FMSI D1136 | .750 [19]

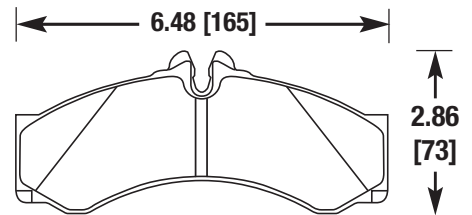

SPRINTER VAN

HB573

F, Z, N | FMSI D1048 | .615 [16]

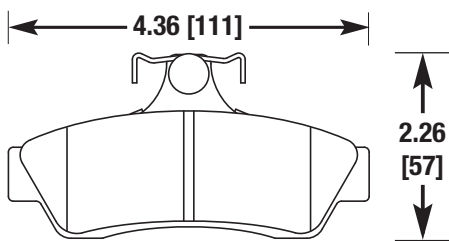

GTO (REAR)

HB577

N, U, G, S | FMSI D961 | .640 [16]

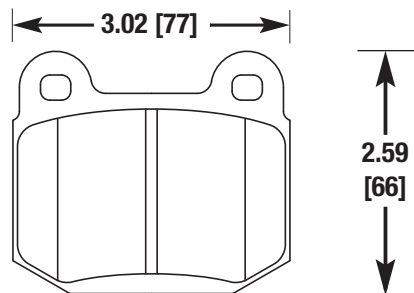

SAME AS HB180X.640 BUT WITH 8 PCS PER SET

HB578

Y | FMSI D1278 | .735 [19]

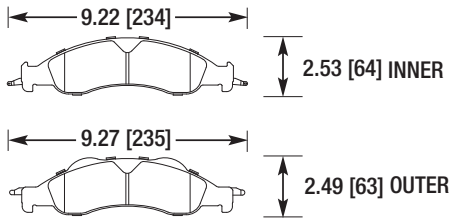

FORD EXPEDITION

HB581

F, Z, N | .660 [17]
U, S

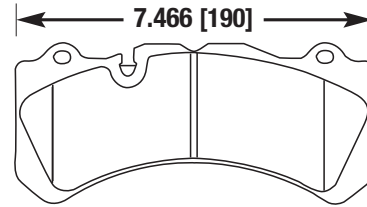

BREMBO SPORT BIG BRAKE KIT

HB579

Y | FMSI D1279 | .785 [20]

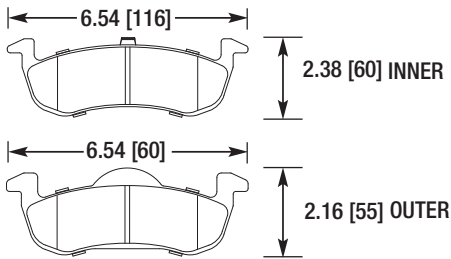

FORD EXPEDITION (REAR)

HB582

F, Z | .660 [17]

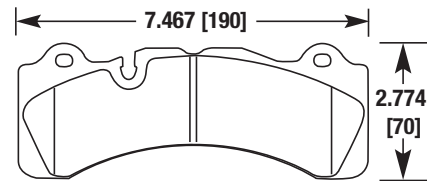

BREMBO SPORT BIG BRAKE KIT SCALLOPED

HB580

F, G, E | FMSI D545 | .627 [16]
FMSI D347

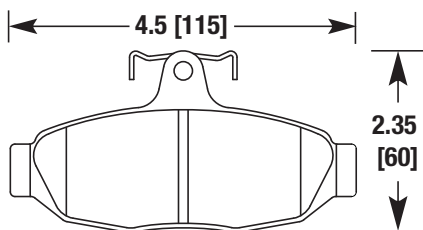

FACTORY 5 (REAR)

HB583

N, H, J | .480 [12]

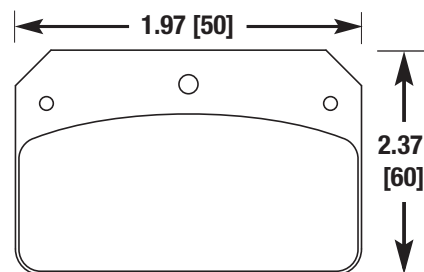

AEROSPACE DYNALITE

HB584

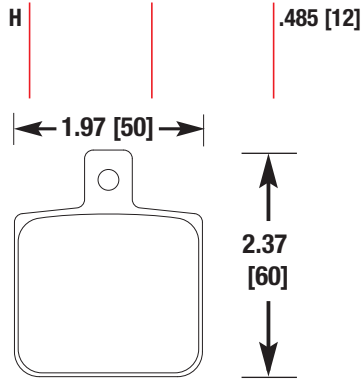

AEROSPACE SINGLE DYNALITE

HB587

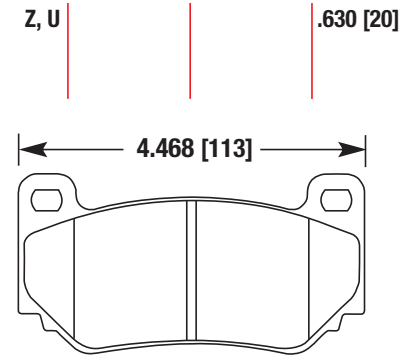

AP RACING CP7600D46

HB585

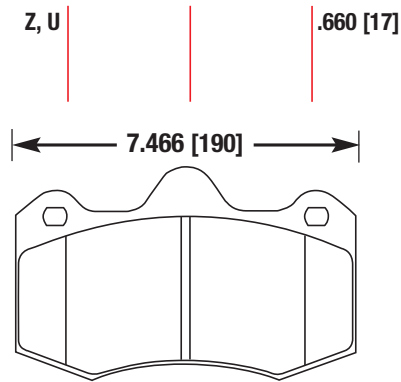

AP RACING CP6600D55

HB588

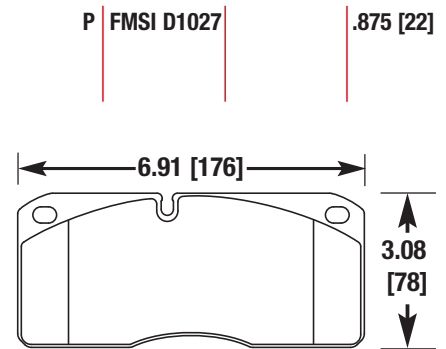

WORKHORSE W42

HB586

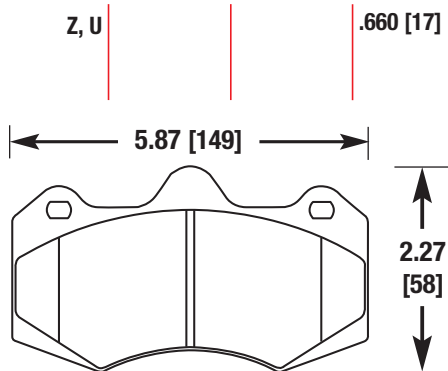

AP RACING CP7040D61

HB589

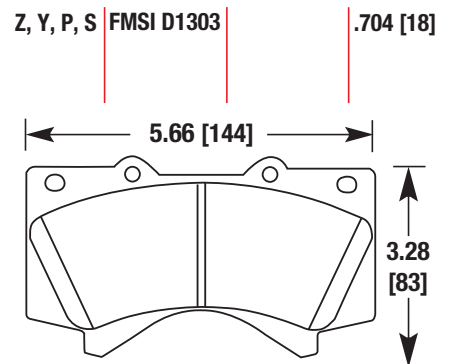

TOYOTA TUNDRA

HB590

Z, Y, P | FMSI D1304 | .682 [17]

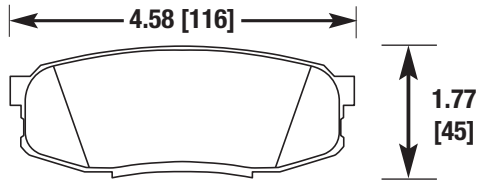

TOYOTA TUNDRA (REAR)

HB593

F | FMSI D1036 | .548 [14]

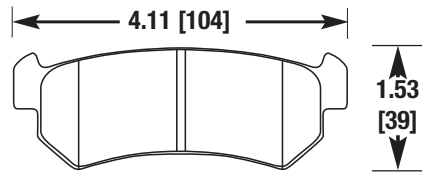

CHEVY OPTRA (REAR)
LATIN AMERICA

HB591

P | FMSI D989 | .760 [19]

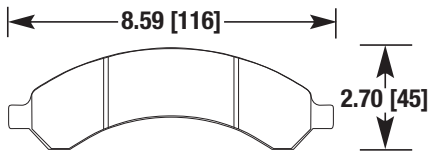

CHEVY/GMC 3500 VAN DRW (REAR)

HB594

F | FMSI D1215 | .657 [17]

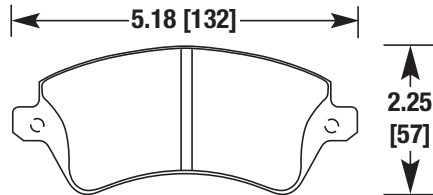

TOYOTA COROLLA 03A (FRONT)
LATIN AMERICA

HB592

F | FMSI D1035 | .665 [17]

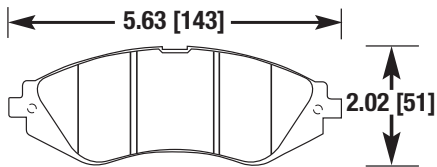

CHEVY OPTRA, AVEO (FRONT)
LATIN AMERICA

HB595

F | FMSI D1216 | .589 [15]

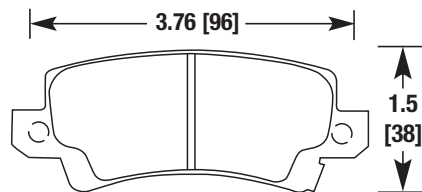

TOYOTA COROLLA 03A TRAS.
(REAR) LATIN AMERICA

HB596

F | FMSI D1184 | .690 [18]

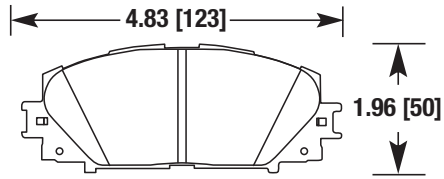

TOYOTA YARIS 05A DEL.
(FRONT) LATIN AMERICA

HB599

F, Z, N | FMSI D1287 | .616 [16]

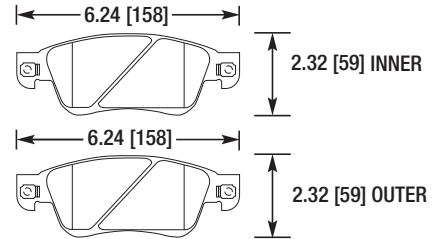

INFINITI G37 (FRONT)

HB597

F | FMSI D766 | .681 [17]

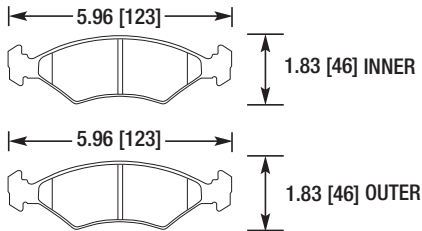

FORD FIESTA, KIA SEPHIA
(FRONT) LATIN AMERICA

HB600

F, Z, N | FMSI D1288 | .539 [14]

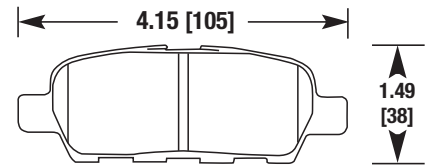

INFINITI G37 (REAR)

HB598

F | FMSI D1193 | .606 [15]

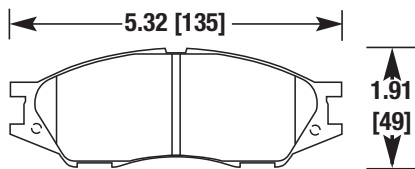

NISSAN ALMERA/SUNNY (FRONT)
LATIN AMERICA

HB601

F, Z, N | FMSI D1346 | .626 [16]

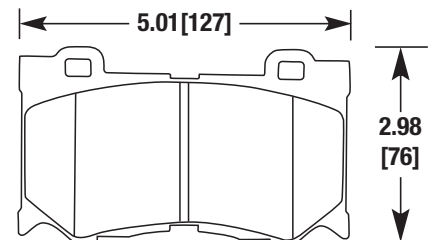

INFINITI G37 SPORT (FRONT)

HB602

F, Z, N | FMSI D1347 | .545 [14]

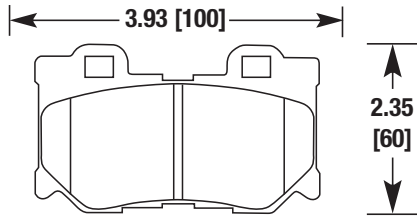

INFINITI G37 SPORT (REAR)

HB604

F, Z, N | FMSI D1372 | .598 [15]

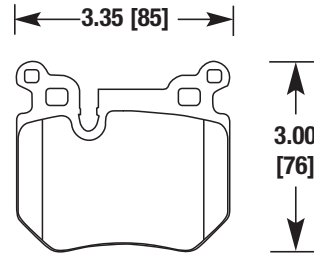

BMW 135i (REAR)

HB603

F, Z, N | FMSI D1371 | .616 [16]

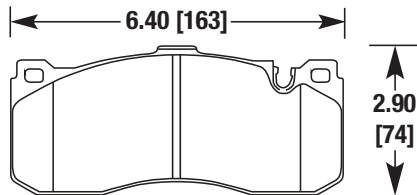

BMW 135i (FRONT)

Notes:

CROSS REFERENCE DATA SORTED BY FMSI NUMBER

FMSI No.	HAWK No.	FMSI No.	HAWK No.	FMSI No.	HAWK No.	FMSI No.	HAWK No.	FMSI No.	HAWK No.
D0004	HB244x.624	D0230	HB262x.540	D0370	HB296x.670	D0470	HB408x.665	D0591	HB241x.710
D0005	HB108x.560	D0231	HB262x.540	D0372	HB141x.650	D0471	HB367x.585	D0592	HB194x.570
D0008	HB126x.505	D0232	HB262x.540	D0372	HB141x.709	D0473	HB246x.567	D0592	HB194x.665
D0011	HB471x.510	D0235	HB151x.505	D0373	HB113x.590	D0474	HB218x.583	D0593	HB308x.689
D0027	HB132x.580	D0236	HB254x1.00	D0374	HB350x.496	D0476	HB318x.669	D0594	HB184x.650
D0031	HB172x.500	D0241	HB191x.590	D0375	HB293x.634	D0477	HB210x.677	D0594	HB184x.650A
D0031	HB172x.595	D0242	HB191x.590	D0375	HB293x.668	D0481	HB437x.585	D0594	HB184x.650B
D0043	HB204x.615	D0249	HB279x.594	D0376	HB232x.681	D0482	HB158x.515	D0594	HB184x.650C
D0044	HB118x.560	D0251	HB199x.660	D0377	HB405x.543	D0484	HB213x.626	D0594	HB184x.708
D0045	HB171x.590	D0251	HB199x.702	D0380	HB252x.860	D0485	HB235x.665	D0594	HB184x.710
D0045	HB171x.720	D0252	HB198x.565	D0383	HB367x.585	D0487	HB195x.640	D0594	HB184x.787
D0050	HB292x.674	D0252	HB198x.685	D0387	HB279x.594	D0491	HB278x.465	D0595	HB421x.622
D0052	HB132x.590	D0253	HB137x.690	D0389	HB407x.602	D0491	HB278x.583	D0597	HB240x.620
D0057	HB169x.560	D0254	HB198x.565	D0392	HB131x.595	D0493	HB195x.640	D0598	HB416x.689
D0058	HB172x.500	D0254	HB198x.685	D0394	HB135x.642	D0499	HB125x.650	D0600	HB182x.660
D0058	HB172x.595	D0256	HB397x.585	D0394	HB135x.770	D0502	HB312x.591	D0601	HB347x.689
D0061	HB123x.535	D0266	HB475x.642	D0395	HB137x.690	D0503	HB143x.680	D0602	HB230x.575
D0076	HB150x.555	D0269	HB398x.680	D0396	HB227x.630	D0504	HB185x.590	D0606	HB477x.610
D0081	HB229x.580	D0272	HB262x.540	D0409	HB242x.661	D0505	HB129x.681	D0607	HB279x.594
D0092	HB292x.674	D0273	HB218x.583	D0410	HB317x.591	D0506	HB390x.602	D0608	HB170x.650
D0094	HB156x.562	D0278	HB195x.640	D0411	HB345x.815	D0507	HB409x.661	D0608	HB170x.710
D0100	HB207x.580	D0279	HB399x.630	D0412	HB111x.610	D0508	HB359x.543	D0609	HB141x.650
D0109	HB180x.560	D0280	HB189x.550	D0413	HB112x.540	D0512	HB176x.614	D0609	HB141x.709
D0109	HB180x.591	D0280	HB189x.595	D0415	HB176x.614	D0521	HB411x.717	D0610	HB417x.659
D0109	HB180x.640	D0282	HB202x.580	D0417	HB240x.620	D0522	HB410x.721	D0611	HB311x.591
D0114	HB169x.560	D0283	HB158x.515	D0419	HB207x.724	D0524	HB411x.717	D0614	HB131x.595
D0120	HB255x.655	D0287	HB171x.590	D0421	HB240x.620	D0525	HB148x.560	D0617	HB245x.631
D0122	HB103x.590	D0287	HB171x.720	D0422	HB231x.575	D0526	HB268x.665	D0618	HB492x.732
D0131	HB152x.540	D0289	HB400x.630	D0422	HB231x.625	D0529	HB308x.689	D0619	HB375x.669
D0138	HB118x.594	D0290	HB190x.600	D0424	HB199x.660	D0530	HB214x.618	D0621	HB418x.646
D0141	HB199x.660	D0290	HB190x.730	D0424	HB199x.702	D0531	HB120x.560	D0623	HB217x.681
D0141	HB199x.702	D0292	HB134x.665	D0429	HB262x.540	D0535	HB230x.575	D0625	HB285x.595
D0145	HB207x.580	D0292	HB134x.706	D0430	HB268x.665	D0536	HB145x.570	D0626	HB295x.630
D0149	HB327x.791	D0294	HB173x.570	D0431	HB263x.650	D0536	HB572x.570	D0627	HB183x.585
D0153	HB131x.595	D0294	HB173x.595	D0431	HB263x.670	D0537	HB145x.570	D0627	HB183x.660
D0154	HB119x.594	D0295	HB112x.540	D0433	HB407x.602	D0539	HB191x.590	D0629	HB215x.630
D0158	HB189x.550	D0302	HB191x.590	D0436	HB315x.669	D0540	HB421x.622	D0630	HB216x.590
D0158	HB189x.595	D0305	HB203x.550	D0439	HB195x.640	D0542	HB413x.690	D0631	HB201x.620
D0159	HB400x.630	D0306	HB271x.605	D0441	HB475x.642	D0543	HB337x.791	D0632	HB295x.630
D0161	HB169x.560	D0306	HB271x.635	D0443	HB199x.660	D0545	HB580x.627	D0635	HB149x.505
D0163	HB206x.565	D0307	HB189x.550	D0443	HB199x.702	D0547	HB325x.720	D0636	HB159x.492
D0163	HB206x.700	D0307	HB189x.595	D0445	HB198x.565	D0548	HB362x.642	D0637	HB211x.606
D0169	HB156x.562	D0313	HB103x.590	D0445	HB198x.685	D0551	HB379x.626	D0639	HB181x.590
D0172	HB156x.562	D0321	HB195x.640	D0446	HB170x.650	D0555	HB269x.763	D0639	HB181x.660
D0174	HB180x.560	D0323	HB262x.540	D0446	HB170x.710	D0555	HB269x.763A	D0641	HB176x.614
D0174	HB180x.591	D0325	HB401x.587	D0447	HB141x.650	D0555	HB269x.763B	D0642	HB177x.630
D0174	HB180x.640	D0331	HB155x.580	D0447	HB141x.709	D0556	HB384x.587	D0642	HB177x.710
D0183	HB400x.630	D0332	HB158x.515	D0449	HB261x.665	D0557	HB333x.776	D0643	HB419x.634
D0184	HB252x.860	D0333	HB402x.669	D0450	HB336x.655	D0558	HB136x.690	D0647	HB178x.564
D0189	HB202x.580	D0334	HB403x.587	D0454	HB195x.640	D0559	HB176x.614	D0648	HB420x.724
D0190	HB400x.630	D0339	HB350x.496	D0455	HB199x.660	D0560	HB218x.583	D0650	HB233x.635
D0199	HB125x.650	D0340	HB364x.587	D0455	HB199x.702	D0562	HB310x.689	D0652	HB283x.650
D0200	HB125x.650	D0340	HB364x.642	D0457	HB148x.560	D0564	HB350x.496	D0654	HB279x.594
D0202	HB119x.594	D0341	HB242x.661	D0458	HB157x.484	D0568	HB144x.690	D0655	HB334x.705
D0205	HB279x.594	D0345	HB170x.650	D0459	HB298x.787	D0568	HB144x.719	D0655	HB334x.736
D0206	HB189x.550	D0345	HB170x.710	D0460	HB178x.564	D0569	HB189x.550	D0656	HB347x.689
D0206	HB189x.595	D0347	HB580x.627	D0461	HB179x.630	D0569	HB189x.595	D0658	HB176x.614
D0213	HB112x.540	D0349	HB404x.642	D0462	HB235x.665	D0570	HB191x.590	D0659	HB205x.672
D0215	HB396x.630	D0352	HB401x.587	D0463	HB155x.580	D0576	HB414x.622	D0661	HB510x.580
D0224	HB253x.750	D0356	HB191x.590	D0463	HB235x.665	D0579	HB422x.610	D0663	HB159x.492
D0225	HB251x1.14	D0360	HB293x.634	D0464	HB262x.540	D0583	HB211x.606	D0664	HB284x.575
D0227	HB190x.600	D0360	HB293x.668	D0465	HB275x.620	D0584	HB212x.535	D0666	HB286x.591
D0227	HB190x.730	D0362	HB270x.724	D0465	HB275x.660	D0585	HB155x.580	D0667	HB287x.571
D0228	HB271x.605	D0368	HB356x.654	D0465	HB275x.720	D0587	HB415x.583	D0668	HB236x.622
D0228	HB271x.635	D0369	HB332x.654	D0468	HB148x.560	D0588	HB437x.585	D0673	HB390x.602

CROSS REFERENCE DATA SORTED BY FMSI NUMBER

FMSI No.	HAWK No.	FMSI No.	HAWK No.	FMSI No.	HAWK No.	FMSI No.	HAWK No.	FMSI No.	HAWK No.
D0674	HB341x.618	D0764	HB275x.620	D0851	HB271x.635	D0961	HB180x.560	D1061	HB534x.750
D0676	HB469x.705	D0764	HB275x.660	D0855	HB326x.646	D0961	HB180x.591	D1063	HB567x.694
D0678	HB205x.672	D0764	HB275x.720	D0856	HB373x.689	D0961	HB180x.640	D1066	HB547x.798
D0679	HB266x.650	D0765	HB416x.689	D0857	HB374x.700	D0961	HB577x.640	D1067	HB556x.710
D0681	HB325x.720	D0766	HB597x.681	D0858	HB372x.626	D0962	HB476x.707	D1068	HB529x.710
D0682	HB497x.776	D0768	HB365x.728	D0859	HB487x.733	D0963	HB503x.790	D1069	HB528x.811
D0683	HB518x.642	D0769	HB344x.992	D0861	HB172x.500	D0965	HB552x.722	D1075	HB360x.670
D0684	HB190x.600	D0770	HB434x.543	D0861	HB172x.595	D0966	HB300x.622	D1076	HB536x.704
D0684	HB190x.730	D0771	HB499x.610	D0862	HB429x.681	D0967	HB513x.610	D1078	HB533x.668
D0685	HB401x.587	D0772	HB313x.685	D0864	HB461x.646	D0968	HB193x.670	D1079	HB300x.622
D0687	HB272x.763	D0773	HB427x.685	D0865	HB506x.610	D0969	HB448x.610	D1080	HB558x.710
D0687	HB272x.763A	D0776	HB291x.642	D0866	HB435x.622	D0970	HB449x.679	D1081	HB484x.670
D0690	HB353x.618	D0777	HB335x.815	D0869	HB498x.772	D0973	HB571x.605	D1082	HB485x.656
D0691	HB326x.646	D0781	HB546x.654	D0872	HB504x.740	D0974	HB494x.670	D1083	HB455x.785
D0692	HB227x.630	D0782	HB176x.614	D0879	HB301x.630	D0975	HB496x.640	D1084	HB559x.695
D0695	HB310x.689	D0784	HB322x.717	D0881	HB520x.575	D0976	HB490x.665	D1086	HB145x.570
D0696	HB190x.600	D0785	HB323x.724	D0882	HB382x.657	D0977	HB501x.625	D1092	HB561x.710
D0696	HB190x.730	D0786	HB327x.799	D0883	HB383x.685	D0978	HB502x.606	D1095	HB478x.605
D0697	HB318x.669	D0786	HB327x.1.05	D0886	HB430x.547	D0989	HB591x.760	D1107	HB543x.760
D0698	HB359x.543	D0787	HB366x.681	D0888	HB387x.547	D0990	HB493x.650	D1108	HB544x.628
D0699	HB360x.670	D0789	HB332x.654	D0890	HB431x.606	D0991	HB483x.635	D1110	HB439x.555
D0700	HB261x.665	D0790	HB380x.700	D0891	HB442x.496	D0992	HB454x.715	D1111	HB538x.760
D0702	HB299x.650	D0791	HB381x.661	D0892	HB436x.535	D0997	HB433x.654	D1112	HB364x.587
D0707	HB320x.669	D0792	HB324x.673	D0893	HB211x.606	D0999	HB450x.555	D1113	HB562x.612
D0709	HB389x.583	D0793	HB386x.669	D0894	HB364x.642	D1000	HB451x.668	D1114	HB557x.545
D0711	HB301x.630	D0794	HB491x.693	D0897	HB300x.622	D1001	HB453x.585	D1119	HB526x.665
D0712	HB210x.677	D0799	HB316x.670	D0898	HB514x.610	D1002	HB468x.492	D1120	HB527x.604
D0713	HB286x.591	D0802	HB539x.650	D0900	HB378x.626	D1003	HB466x.780	D1136	HB575x.750
D0714	HB359x.543	D0803	HB342x.701	D0903	HB461x.646	D1004	HB452x.545	D1149	HB563x.656
D0717	HB252x.860	D0804	HB274x.610	D0904	HB438x.606	D1006	HB481x.750	D1159	HB535x.638
D0718	HB318x.669	D0805	HB376x.665	D0905	HB370x.559	D1007	HB512x.605	D1161	HB564x.567
D0720	HB423x.709	D0806	HB428x.650	D0908	HB474x.681	D1008	HB378x.565	D1164	HB565x.688
D0721	HB352x.665	D0807	HB384x.587	D0912	HB363x.689	D1009	HB470x.643	D1178	HB566x.688
D0722	HB424x.665	D0810	HB193x.670	D0913	HB472x.650	D1010	HB511x.790	D1179	HB522x.565
D0723	HB214x.618	D0812	HB314x.665	D0914	HB393x.665	D1011	HB455x.785	D1180	HB523x.539
D0725	HB135x.642	D0814	HB359x.543	D0915	HB515x.760	D1012	HB456x.705	D1181	HB558x.710
D0725	HB135x.770	D0815	HB268x.665	D0917	HB550x.634	D1013	HB461x.646	D1182	HB178x.564
D0726	HB304x.598	D0816	HB346x.713	D0918	HB551x.748	D1014	HB501x.625	D1183	HB567x.694
D0727	HB425x.661	D0817	HB328x.685	D0921	HB439x.555	D1016	HB453x.585	D1184	HB596x.690
D0728	HB409x.661	D0818	HB360x.670	D0922	HB440x.606	D1017	HB364x.642	D1185	HB531x.570
D0729	HB305x.610	D0819	HB388x.756	D0923	HB441x.661	D1018	HB553x.652	D1185	HB531x.570
D0730	HB260x.670	D0820	HB307x.795	D0924	HB368x.665	D1019	HB467x.540	D1186	HB549x.702
D0731	HB247x.575	D0821	HB487x.733	D0928	HB479x.700	D1023	HB364x.642	D1193	HB598x.606
D0732	HB248x.650	D0822	HB493x.650	D0929	HB432x.661	D1025	HB264x.575	D1194	HB568x.666
D0737	HB289x.610	D0823	HB329x.543	D0931	HB433x.654	D1027	HB588x.875	D1204	HB560x.677
D0738	HB290x.583	D0824	HB302x.700	D0932	HB443x.614	D1028	HB524x.740	D1215	HB594x.657
D0738	HB290x.606	D0825	HB537x.783	D0934	HB462x.827	D1033	HB525x.540	D1216	HB595x.589
D0740	HB495x.756	D0829	HB361x.622	D0935	HB463x.787	D1035	HB592x.665	D1224	HB360x.670
D0741	HB321x.650	D0830	HB488x.629	D0936	HB388x.756	D1036	HB593x.548	D1247	HB122x.710
D0744	HB318x.669	D0833	HB472x.650	D0939	HB444x.685	D1037	HB457x.605	D1260	HB551x.748
D0745	HB420x.724	D0834	HB385x.640	D0940	HB445x.610	D1039	HB554x.643	D1273	HB569x.650
D0746	HB306x.795	D0836	HB354x.756	D0942	HB380x.700	D1041	HB555x.678	D1278	HB578x.735
D0747	HB261x.665	D0837	HB500x.645	D0943	HB393x.665	D1042	HB458x.642	D1279	HB579x.785
D0748	HB294x.646	D0838	HB516x.626	D0944	HB428x.650	D1043	HB460x.580	D1287	HB599x.616
D0749	HB249x.575	D0839	HB363x.689	D0945	HB446x.725	D1044	HB519x.682	D1288	HB600x.539
D0750	HB250x.653	D0840	HB354x.756	D0946	HB464x.764	D1048	HB573x.615	D1303	HB589x.704
D0752	HB425x.661	D0841	HB371x.600	D0947	HB465x.764	D1049	HB530x.570	D1304	HB590x.682
D0754	HB359x.543	D0841	HB377x.760	D0948	HB418x.646	D1050	HB453x.585	D1308	HB570x.666
D0755	HB489x.630	D0842	HB300x.622	D0949	HB480x.750	D1053	HB194x.570	D1309	HB574x.636
D0756	HB302x.700	D0843	HB473x.752	D0955	HB461x.646	D1053	HB194x.665	D1346	HB601x.626
D0757	HB303x.685	D0844	HB373x.689	D0956	HB517x.690	D1056	HB507x.711	D1347	HB602x.545
D0758	HB300x.622	D0845	HB296x.670	D0957	HB459x.700	D1057	HB508x.586	D1371	HB603x.616
D0759	HB176x.614	D0849	HB376x.665	D0958	HB393x.665	D1057	HB508x.675	D1372	HB604x.598
D0760	HB505x.654	D0850	HB360x.670	D0959	HB447x.667	D1058	HB509x.678		
D0763	HB227x.630	D0851	HB271x.605	D0960	HB545x.564	D1060	HB445x.610		